

Lecture 3

Fefferman's Theorem: A heuristic proof

$$\text{Let } S_1 f(x) := \int_{B(0,1)} e^{2\pi i \langle x, \xi \rangle} \hat{f}(\xi) d\xi.$$

This operator is called the ball multiplier.

Recall,

Theorem (C. Fefferman) For $p \neq 2$ and $n \geq 2$ the ball multiplier is unbounded on L^p :-

$$\|S_1\|_{p \rightarrow p} = \infty.$$

In the first lecture, we noted that this implies the failure of L^p convergence of the spherical Fourier summation method for $p \neq 2$.

In this lecture we will give a heuristic proof of Fefferman's theorem, based on the uncertainty principle and a clever geometric construction.

Given N we want to find $f \in L^p$ such that

$$\|S_1 f\|_p \geq N \cdot \|f\|_p.$$

Let's suppose $p > 2$ so f has a (relatively) broad, flat distribution if it lies in L^p .

We want $S_1 f$ to have a tall, thin distribution so that $\|S_1 f\|_p$ is large.

Observation 1: All the action happens on/near the boundary of the ball.

• For any $R \gg 1$, the multiplier $\chi_{B(0,1)}$ is C^∞ on $B(0, 1-1/R)$ (and therefore well-behaved "on this set").

In particular, if ϕ_R is a Schwartz function satisfying

$$\text{supp } \phi_R \subseteq B(0, 1)$$

$\phi_R(\xi) = 1$ for $\xi \in B(0, 1/2)$,
then

$$\begin{aligned} \chi_{B(0,1)} &= \chi_{B(0,1)} \cdot \phi_R + \chi_{B(0,1)} \cdot (1 - \phi_R) \\ &= M_{R,1} + M_{R,2} \end{aligned}$$

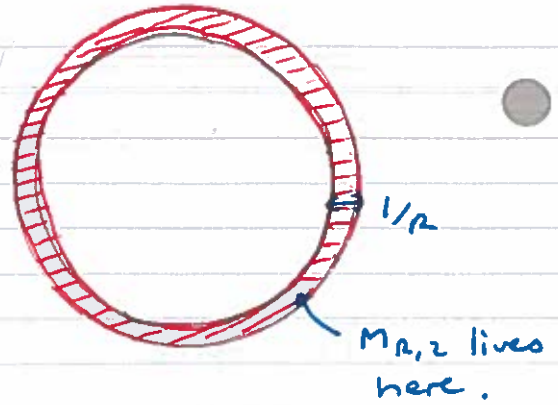

$M_{R,1} \in C_c^\infty(\mathbb{R}^n)$ and so, writing

$$S_\perp = S_{R,1} + S_{R,2} \quad \text{where}$$

$$S_{R,1} f(x) = \int_{\widehat{\mathbb{R}}^n} e^{2\pi i \langle x, \xi \rangle} M_{R,1}(\xi) \widehat{f}(\xi) d\xi$$

it follows that $\|S_{R,1}\|_{p \rightarrow p} \leq C_R < \infty$.

Thus, it suffices to prove the result with S_\perp replaced with $S_{R,2}$ (we won't actually make use of this "reduction", but it helps to motivate the following).

Note that $M_{R,2}$ is supported on the thin annular region $1 - 1/2 \leq |\xi| \leq 1$

Thus, when looking for a counterexample f we should consider f with Fourier support near the boundary of the ball.

Observation 2: Wave packets.

Let's try to analyze the behaviour of f satisfying $\text{supp } \widehat{f} \subseteq A_R := \{ \xi \in \widehat{\mathbb{R}}^n : 1 - 1/2 \leq |\xi| \leq 1 + 1/2 \}$

The problem is that A_R is highly non-convex (it doesn't look like an ellipse or a rectangle at all), so we can't apply the uncertainty heuristics directly.

$\Theta = R^{-1/2} \times \dots \times R^{-1/2} \times R^{-1}$ rectangle.

3

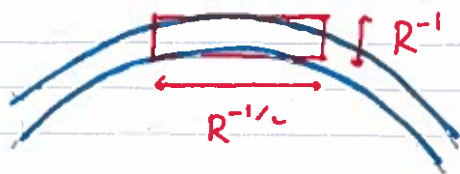

For simplicity, let's consider functions with Fourier support in a 'maximal convex subset' of \mathbb{A}^n .

This is essentially a rectangle Θ lying tangent to S^{n-1} with long sides of length $R^{-1/2}$ in the tangent directions and a short side of length R^{-1} in the normal direction.

Let $\phi_\Theta \in \mathcal{S}(\mathbb{R}^n)$ be a bump function concentrated on Θ , normalized to have mass 1.

By the uncertainty principle ϕ_Θ^\vee is a Schwartz function concentrated on $T_\Theta = \Theta^\vee$.

T_Θ is a tube centered at the origin of dimensions $R^{1/2} \times \dots \times R^{1/2} \times R$. The long side points in the normal direction to S^{n-1} on Θ , which we call $G(\Theta)$.

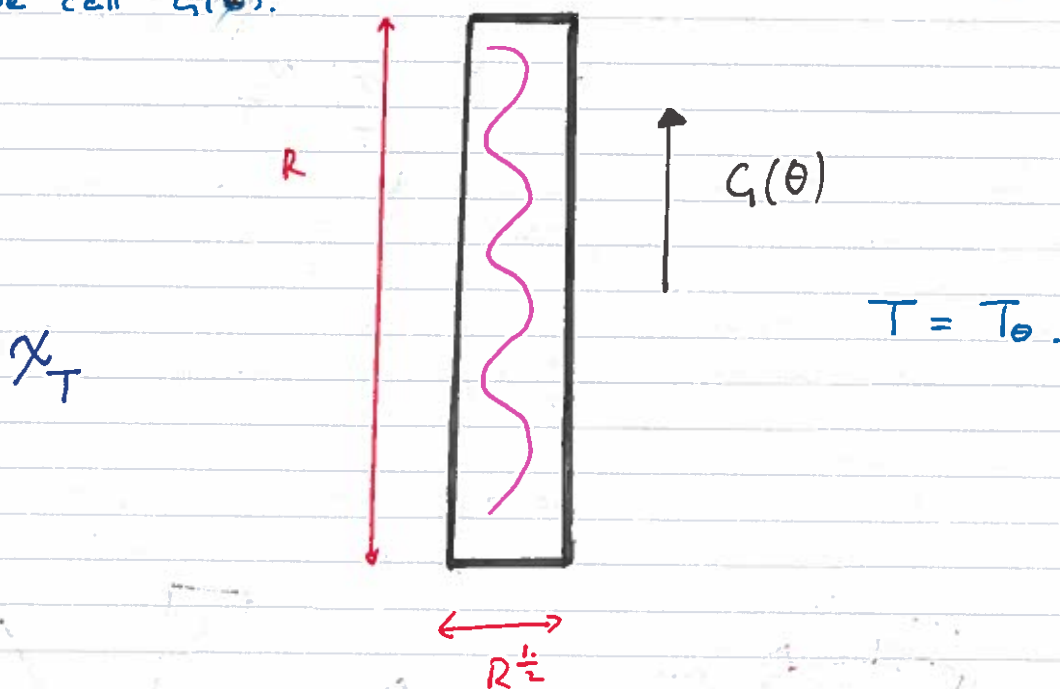

(for concreteness, we can take $G(\Theta) = \omega_\Theta \in S^{n-1}$ where ω_Θ is the "centre" of the rectangle Θ , but since the normal does not vary much in $\Theta \cap S^{n-1}$ the precise choice is unimportant).

Thus, if we define $\chi_T := (\phi_\Theta)^\vee$ then, heuristically,

$$\chi_T = e^{2\pi i \langle x, \omega_\Theta \rangle} \chi_T$$

The oscillatory factor $e^{2\pi i \langle x, \omega_\theta \rangle}$, where ω_θ above ω_0 is the centre of Θ , arises from the displacement of Θ from the origin.

Each χ_T is referred to as a 'wave packet'.

Observation 3:- Superpositions of wave packets

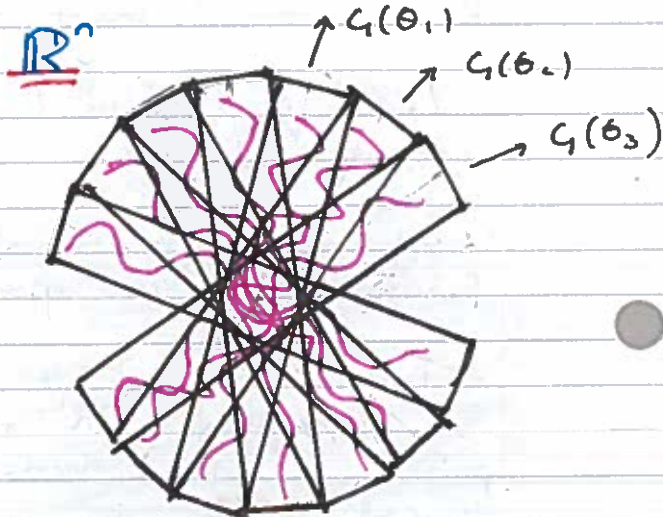
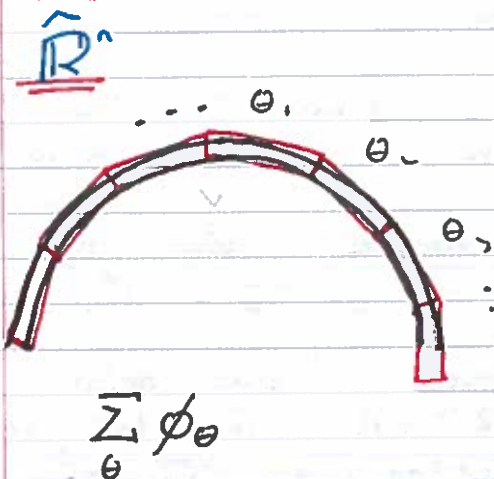

$$\sum_T \chi_T$$

We can roughly cover \mathbb{R}^n with 'caps' Θ and form a superposition $\sum_{\theta} \phi_{\theta}$

On the spacial side we have a superposition of wave packets $\sum_T \chi_T$ all passing through Θ .

The wave packets

- point in distinct directions $G(\theta)$
- each carry a distinct oscillation

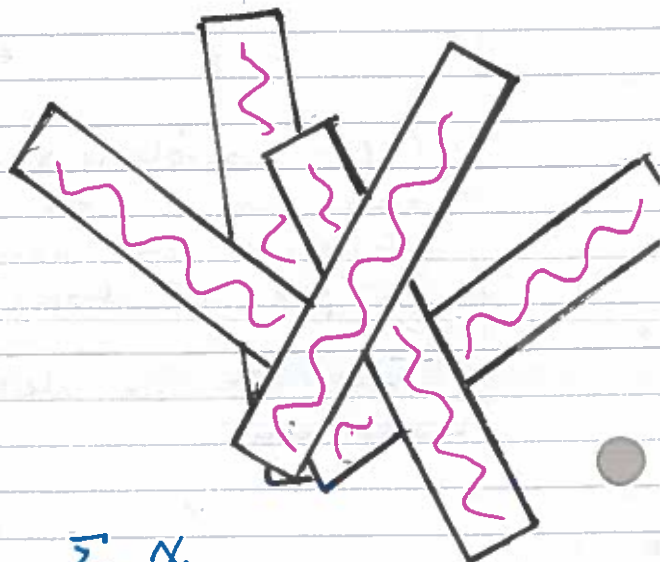
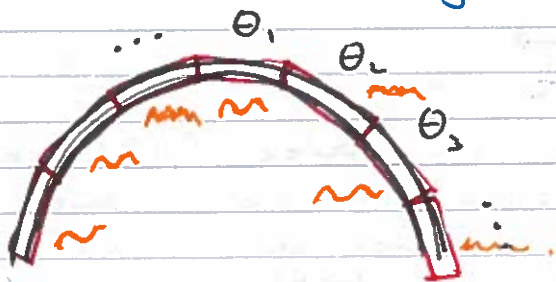

We can also modulate the ϕ_{θ} :-

$$\sum_{\theta} e^{2\pi i \langle \xi, x_{\theta} \rangle} \phi_{\theta}$$

$$\sum_T \chi_{T+x_T}$$

On the spatial side, this allows us to freely translate the tubes.

- We'll choose the translates so that the resulting tubes $\{T+x_T\}$ are pairwise disjoint.
- Relabel the translated tubes $T+x_T \rightarrow T$.
- Because of the disjoint supports of the χ_T ,

$$\left\| \sum_T \chi_T \right\|_p \sim \left(\sum_T |T| \right)^{1/p} = \left| \bigcup_T T \right|^{1/p}$$

Observation 4 : Action of S_1 on χ_T .

Since each 'cap' Θ lies tangentially to S^{n-1} , the operator S_1 essentially chops the support of ϕ_Θ in half:-

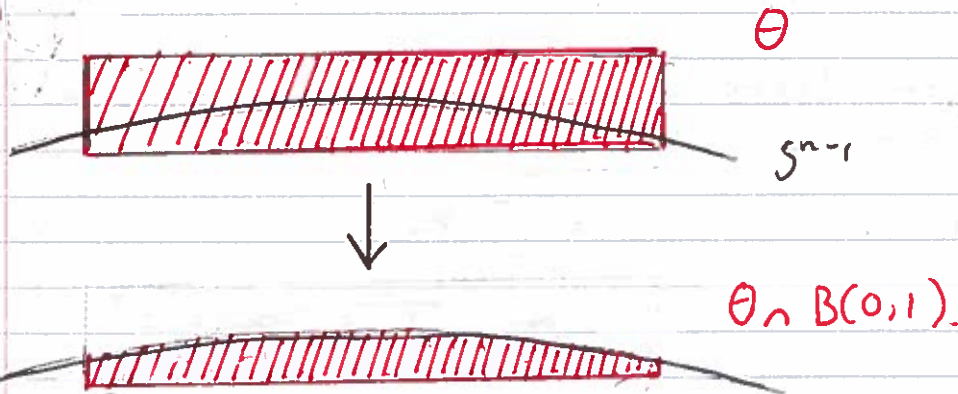

ie. we only retain the portion lying in $B(0,1)$.

In fact, by adjusting the setup, we can arrange things so we retain some fixed, but arbitrary proportion of each Θ - say $1/5$.

Thus, by the uncertainty principle:

$1/5 \times$ freq. support in normal direction



$5 \times$ spatial support in normal direction.

In particular, $\sum_T S_\perp \chi_T$ should be concentrated on a tube \tilde{T} given by expanding T by a factor of 5 in the long direction:-

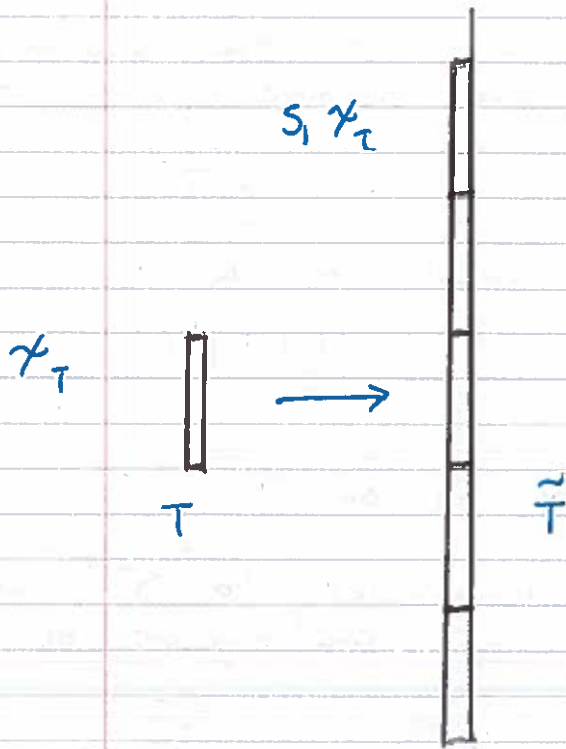

Review:- Let's review the setup on the spatial side:-

- We have
$$f = \sum_T \chi_T$$

where each χ_T is a 'wave packet' concentrated on a $R^{1/2} \times \dots \times R^{1/2} \times R$ tube T .

- The tubes are disjoint so that

$$\|f\|_p \sim \left| \bigcup_T T \right|^{1/p} \quad (1)$$

- The tubes point in distinct directions (separated by $R^{1/2}$).

- $S_\perp f = \sum_T S_\perp \chi_T$ where each $S_\perp \chi_T$ is concentrated on \tilde{T} a stretched version T .

Observation S_\perp - Destructive interference.

Heuristically, $|S_\perp \chi_T| \sim \chi_{\tilde{T}}$ for each T , but since the \tilde{T} can overlap and each $S_\perp \chi_T$ carries some oscillation, we cannot conclude

that

$$|S_{\perp} f| = \left| \sum_T S_{\perp} \chi_T \right| \sim \left| \sum_T \chi_{\tilde{T}} \right|.$$

Controlling the interference patterns between the $S_{\perp} \chi_T$ can be complicated - we use a randomisation trick to simplify matters.

Idea:- Replace f with

$$f := \sum_T \epsilon_T \chi_T$$

where ϵ_T are IID random signs ± 1 .

Clearly, property (1) still holds. On the other hand, Khintchine's inequality tells us that on average we can expect

$$\left| \sum_T \epsilon_T S_{\perp} \chi_T \right| \sim \left(\sum_T \chi_{\tilde{T}} \right)^{1/2} \quad (2)$$

The $\sqrt{\cdot}$ accounts for cancellation between the terms.

Thus, we can work with a 'typical' choice of random sign sequence ϵ_T and thereby assume

$$\|f\|_p \sim \left| \sum_T T \right|^{1/p} \quad \text{and} \quad \|S_{\perp} f\|_p \sim \left\| \sum_T \chi_{\tilde{T}} \right\|_{p/2}^{1/2}$$

Remark:- 1. This discussion is a little inaccurate since Khintchine's theorem is applied pointwise in (2) so there is no reason to expect a 'uniform' choice of sign sequence. In practice, one works with expected values of $\|S_{\perp} f\|_p$ over all random sign choices.

2. The use of randomisation here at first sight appears strange:- $\sqrt{\cdot}$ cancellation is typically 'best possible' and represents highly non-correlated behaviour between the terms of the sum (c.f. the Pythagorean theorem vs the triangle inequality).

For our purposes, we want to maximise the size of $\|S_{\perp} f\|_p$ (relative to $\|f\|_p$) so we should want as little cancellation as possible.

However, there is a theory of square functions for functions with Fourier support close to S^{n-1} which indicates (at least for $n=2$) that such $\sqrt{\cdot}$ decay is unavoidable when trying to cook up an example of this kind.

Finally, let T_+ denote the uppermost $1/5$ of T so that $|T| = |T_+|$, but T_+ is shifted away from T in the long direction:-

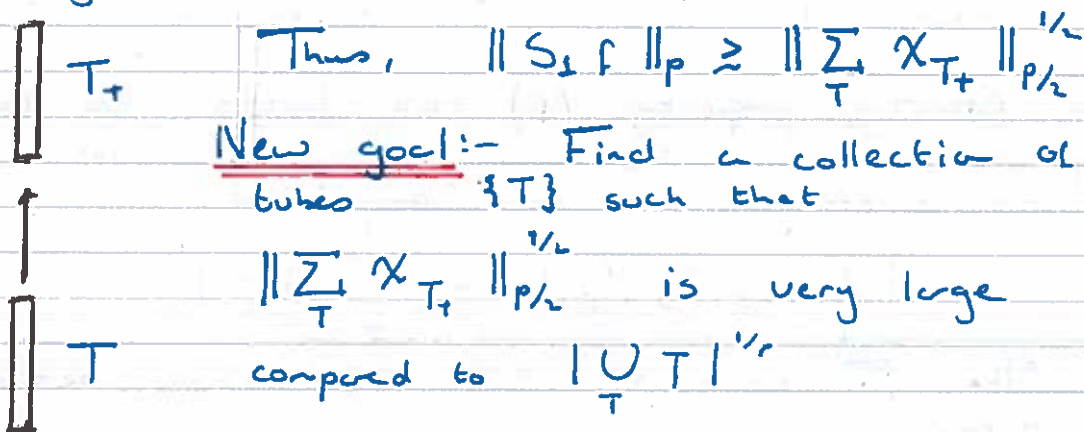

Key Observation:- For all $M \geq 1$ there exists some $R \geq 1$ and a family of $R^{1/2} \times \dots \times R^{1/2} \times R$ tubes $\{T\}$ such that

$$\left| \bigcup_T T_+ \right| \leq M^{-1} \left| \bigcup_T T \right| = M^{-1} \sum_T |T|.$$

Once we have this, we can proceed as follows:- by Hölder

$$\begin{aligned} \left| \bigcup_T T \right| &= \sum_T |T| = \sum_T |T_+| \\ &\leq \left| \bigcup_T T_+ \right|^{1-2/p} \left\| \sum_T \chi_{T_+} \right\|_{p/2}^{2/p} \\ &\leq M^{-(1-2/p)} \left| \bigcup_T T \right|^{1-2/p} \left\| \sum_T \chi_{T_+} \right\|_{p/2}^{2/p} \end{aligned}$$

Rearranging,

$$\left\| \sum_T \chi_{T_+} \right\|_{p/2}^{1/2} \geq M^{1/2-1/p} \left| \bigcup_T T \right|^{1/p}$$

Thus,

$$\|S_{\perp} f\|_p \geq \left\| \sum_T \chi_{T_+} \right\|_{p/2}^{1/2} \geq M^{1/p - 1/2} \left| \bigcup_T T \right|^{1/p}$$

$$\sim M^{1/p - 1/2} \|f\|_p.$$

Since $p > 2$ and $M \gg 1$ can be arbitrarily large, this proves (heuristically) Fefferman's theorem, modulo the purely geometric key observation

The Kakeya Problem.

We have reduced Fefferman's theorem to the following geometric problem:-

Given $M \gg 1$, find some $R \gg 1$ and a set Π of disjoint, direction-separated $R^{1/2} \times \dots \times R^{1/2} \times R$ tubes (rectangles) in \mathbb{R}^n such that

$$\left| \bigcup_{T \in \Pi} T_+ \right| \leq M^{-1} \left| \bigcup_{T \in \Pi} T \right|. \quad (*)$$

Here T_+ is the shift of T in the long direction, as described earlier.

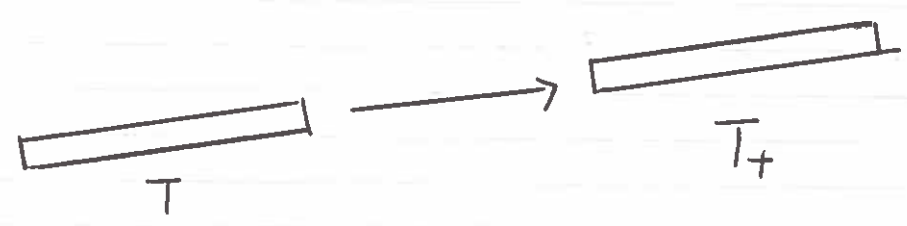

• What does (*) mean? Since $T \in \Pi$ are disjoint

$$\left| \bigcup_{T \in \Pi} T \right| = \sum_{T \in \Pi} |T| = \sum_{T \in \Pi} |T_+|$$

so (*) reads

$$\left| \bigcup_{T \in \Pi} T_+ \right| \leq M^{-1} \sum_{T \in \Pi} |T_+|.$$

Since $\left| \bigcup_{T \in \Pi} T_+ \right|$ is much smaller than $\sum_{T \in \Pi} |T_+|$,

the shifted tubes are far from disjoint - they heavily overlap.

Thus we want :-

• A set of disjoint tubes \mathbb{T} which point in many different directions such that the translates $\{T_+ : T \in \mathbb{T}\}$ heavily overlap.

* Once we have a family of heavily overlapping tubes T_+ , it is not so difficult to ensure that the T are disjoint basically using the fact that direction-separated lines can only intersect at a single point.

* The main difficulty is to "force" the T_+ , which point in different directions, to overlap one another.

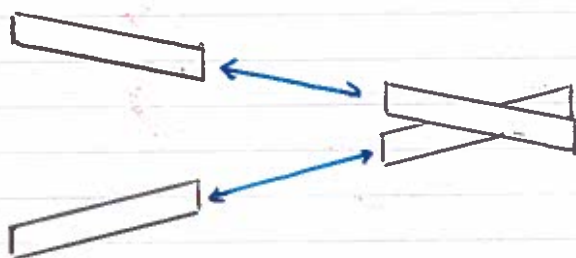

This is related to the following (continuum) geometric problem :-

Defⁿ :- A compact set $K \subseteq \mathbb{R}^n$ is Kakeya if it contains a unit line segment in every direction; that is, for all "directions" $e \in S^{n-1}$ there exists some translate $x_e \in \mathbb{R}^n$ such that

$$x_e + \ell_e \subseteq K \quad \text{where} \quad \ell_e := \{t \cdot e : |t| \leq 1/2\}.$$

Examples in \mathbb{R}^2 :-

(Deltoid)

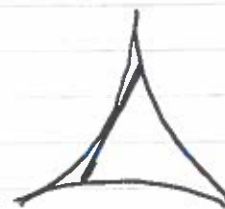
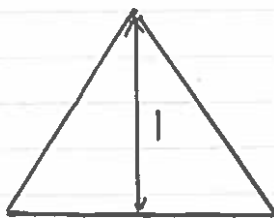

Question: (Kakeya) What is the smallest possible area of a Kakeya set in \mathbb{R}^2 ?

Theorem (Besicovitch) There exists a Kakeya subset of \mathbb{R}^2 of (planar) Lebesgue measure zero.

We'll discuss the ideas behind constructing Kakeya sets of arbitrary small measure; a measure zero Kakeya set can then be obtained via a simple limiting argument.

Take the equilateral triangle example and chop it in 2 :-

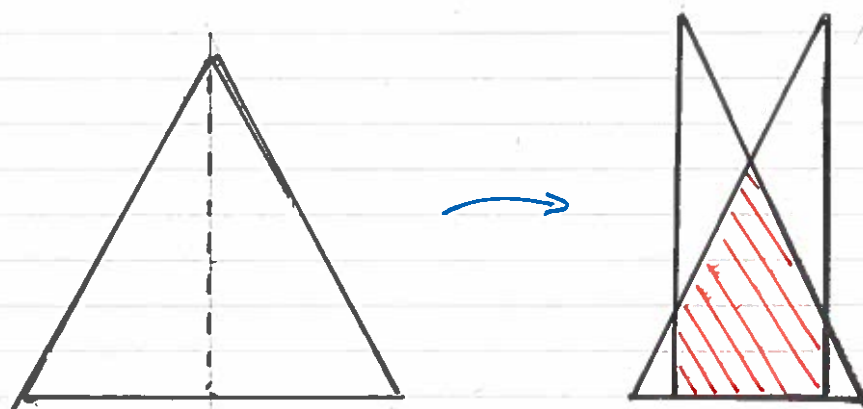

If we slide the two subtriangles horizontally so that they overlap, then we obtain a new figure with "120° worth of directions" but smaller area.

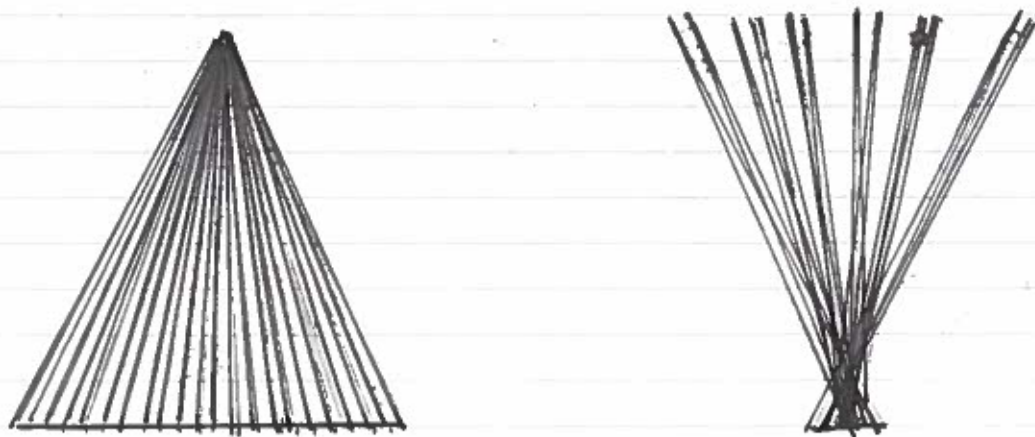

If we partition the original triangle into many subtriangles, we can create more overlap and obtain a figure with "120° worth of directions" but very small area.

In fact, by choosing the number of partitioning

subtriangles sufficiently large, we can make the area of the resulting figure arbitrarily small.

The resulting figure is called a "Perron tree".

Going back to our "Key Observation", the T are chosen to lie in disjoint regions defined by the constituent triangles of the Perron tree:-

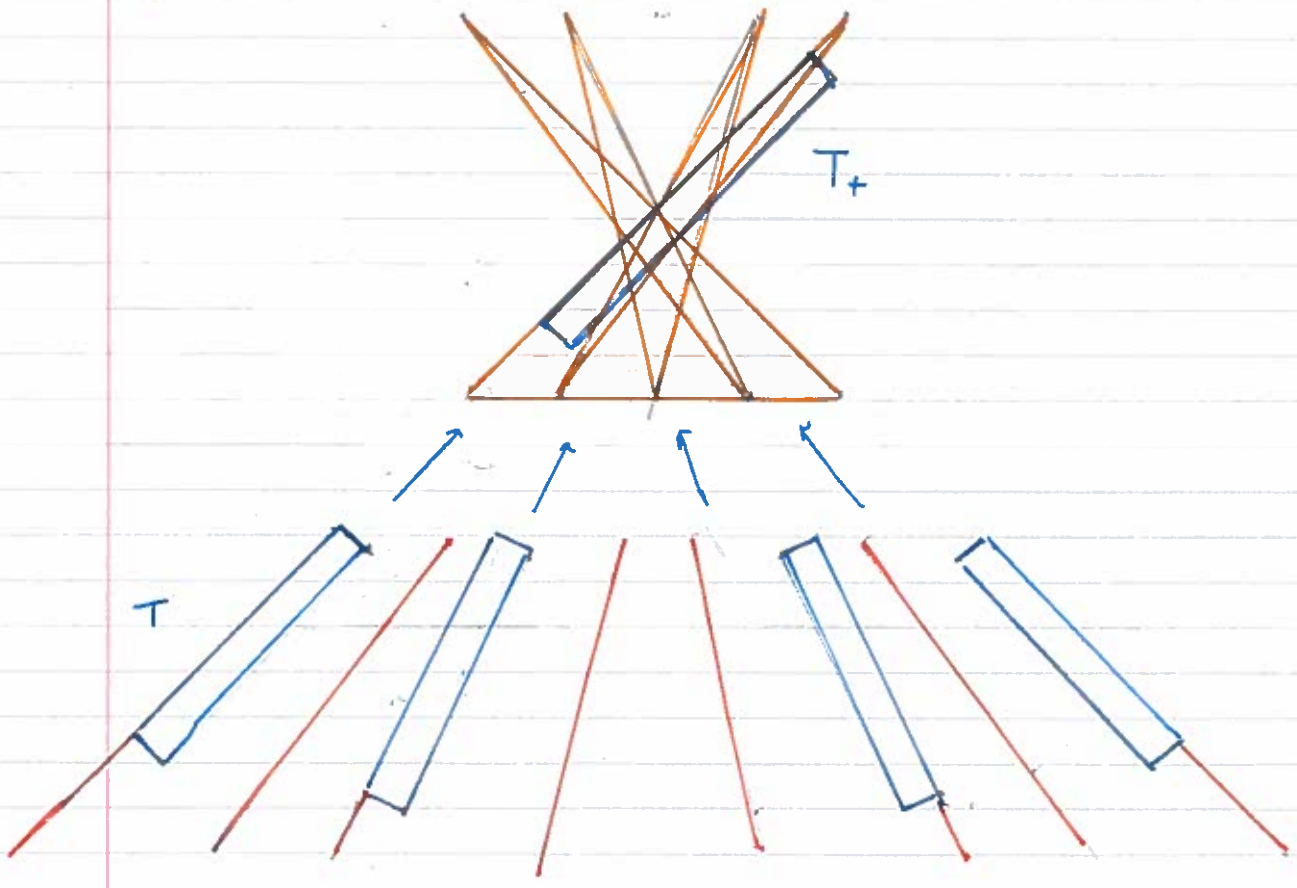

Translating the tubes T , the T_+ land on top of the Perron tree and consequently have huge overlap owing to the overlap of the constituent triangles.