

Andrew Ranicki

# MICROBUNDLES

## PART I

J. MILNOR

(Received 10 April 1963)

### §1. INTRODUCTION

THIS paper will define the concept of (topological) microbundles, and prove a number of fundamental properties.

The following paragraph is intended to motivate this concept. (For further motivation, see the author's preliminary report [15].) Suppose that one tries to construct something like a 'tangent bundle' for a manifold  $M$  which has no differentiable structure. Each point  $x \in M$  has neighborhoods which are homeomorphic to Euclidean space. It would be plausible to choose one such neighborhood  $U_x$  for each  $x$ , and to call  $(x) \times U_x$  the 'fibre' over  $x$ . Unfortunately however, it seems difficult to choose such a neighborhood  $U_x$  simultaneously for each  $x \in M$ , in such a way that  $U_x$  varies continuously with  $x$ . Furthermore even if such a choice were possible, it is not clear that the resulting object would be a topological invariant of  $M$ . To get around these difficulties we consider a new type of bundle, in which the fibre is only a 'germ' of a topological space. Thus for the tangent microbundle of  $M$ , the fibre over  $x$  is a completely arbitrary neighborhood of  $x$  (subject only to the uniformity condition that the set of all  $(x, y)$  with  $y \in U_x$  should form a neighborhood of the diagonal in  $M \times M$ ). At any stage of the argument we will be allowed to pass to smaller neighborhoods; hence any particular choice of the  $U_x$  becomes irrelevant.

The paper is organized as follows. In §§2-7 it is shown that microbundles behave very much like vector bundles. The concepts of tangent microbundle, induced microbundle, Whitney sum, and normal microbundle are studied; and a version of the covering homotopy theorem is proved. (Sections 2, 3, 4, 5, 6 respectively). On the other hand in §8 and §9 the differences between microbundles and vector bundles are emphasized. Thus it is shown that a non-trivial vector bundle may give rise to a trivial microbundle (§9.1). As an application it is shown that the tangent vector bundle of a smooth† manifold is not, in general, a topological invariant.

I hope to develop these ideas further in one or more later papers: in particular to study the analogous concept of piecewise-linear microbundle, to construct universal microbundles, and to study characteristic classes.

† The word 'smooth' will always mean differentiable of class  $C^\infty$ .

At this point I wish to express my indebtedness to ARNOLD SHAPIRO. Many extremely useful discussions with Shapiro served to crystallize the concept of microbundle. In particular the word 'microbundle' itself is Shapiro's invention.

## §2. DEFINITIONS AND EXAMPLES

The notation  $\mathbf{R}^n$  will be used for  $n$  dimensional Euclidean space.

DEFINITION. A microbundle  $x$  is a diagram

$$B \xrightarrow{i} E \xrightarrow{j} B$$

consisting of the following:†

- (1) a topological space  $B$  called the base space;
- (2) a topological space  $E$  or  $E(x)$  called the total space,

and

- (3) continuous maps  $i$  and  $j$  called the injection and projection maps respectively. The composition  $ji$  is required to be the identity map of  $B$ . Furthermore we require:

*Local triviality condition.* For each  $b \in B$  there should exist an open neighborhood  $U$  of  $b$  and an open neighborhood  $V$  of  $i(b)$ , with

$$i(U) \subset V, \quad j(V) \subset U,$$

so that  $V$  is homeomorphic to  $U \times \mathbf{R}^n$  under a homeomorphism which makes the following diagram commutative:

$$\begin{array}{ccc}
 & V & \\
 i|U \nearrow & & \searrow j|V \\
 U & & U \\
 \times 0 \searrow & & \nearrow p_1 \\
 & U \times \mathbf{R}^n & 
 \end{array}$$

Here  $\times 0$  denotes the injection  $u \rightarrow (u, 0)$ , and  $p_1$  denotes the projection  $p_1(u, x) = u$ . The integer  $n \geq 0$  is called the *fibre dimension* of  $x$ .

*Remark.* Note that  $E$  can be more or less arbitrary except in the neighborhood of  $i(B)$ . Only the neighborhoods of  $i(B)$  in  $E$  will play an essential role in the theory. For example if  $E'$  is an arbitrary neighborhood of  $i(B)$  in  $E$ , then we will see that the microbundle

$$B \xrightarrow{i} E' \xrightarrow{j|E'} B$$

can be identified with  $x$  for all practical purposes. (Compare the definition of 'isomorphism' below.)

† German letters such as  $x, t, e$  will be used for microbundles; while Greek letters such as  $\xi, \tau, \epsilon$  will be used for vector bundles.

Here are three examples.

Example (1). For any  $B$  and any  $n \geq 0$  the diagram

$$B \xrightarrow{\times 0} B \times \mathbb{R}^n \xrightarrow{p_1} B$$

constitutes a microbundle over  $B$ . This will be called the standard *trivial* microbundle. It will be denoted by  $e^n$  or  $e_B^n$ .

Example (2). Let  $\xi$  be an  $n$ -dimensional vector bundle over  $B$  (i.e., a fibre bundle with  $\mathbb{R}^n$  as fibre and the general linear group  $GL(n, \mathbb{R})$  as structural group). Let  $E$  be the total space,  $j$  the projection map, and

$$i: B \rightarrow E$$

the zero cross-section [which maps each  $b \in B$  to the zero vector in the vector space  $j^{-1}(b)$ ]. Then the diagram

$$B \xrightarrow{i} E \xrightarrow{j} B$$

constitutes a microbundle. This will be called the *underlying microbundle* of  $\xi$ , and will be denoted by  $|\xi|$ .

Example (3). Let  $M$  be any topological manifold, and let  $\Delta: M \rightarrow M \times M$  denote the diagonal map.

LEMMA (2.1). The diagram  $M \xrightarrow{\Delta} M \times M \xrightarrow{p_1} M$  constitutes a microbundle.

This will be called the *tangent microbundle* of  $M$ , and will be denoted by  $t$  or  $t_M$ .

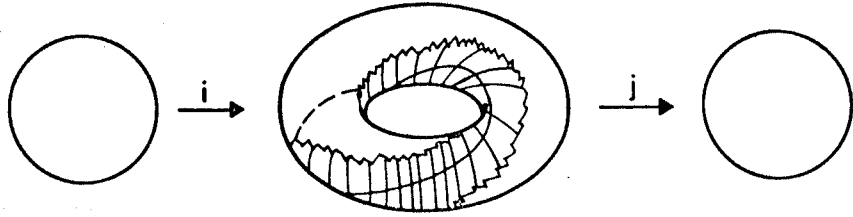

FIG. 1. THE TANGENT MICROBUNDLE OF THE CIRCLE. THE IMAGE  $i(S^1)$  AND THE FIBRES  $j^{-1}(b)$  ARE EMPHASIZED.

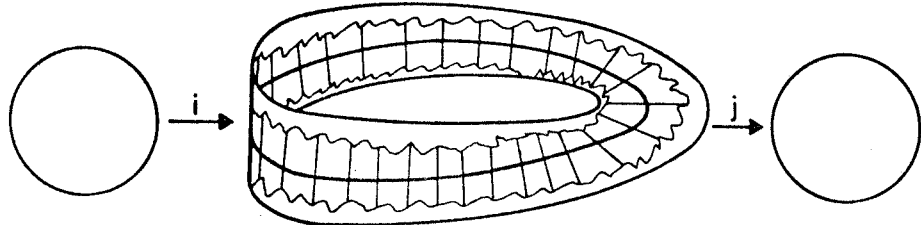
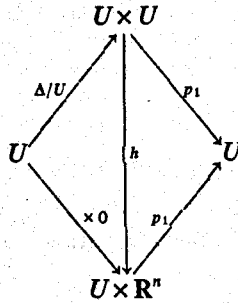

FIG. 2. A NON-TRIVIAL MICROBUNDLE OVER THE CIRCLE

Proof. Clearly  $p_1 \circ \Delta$  is the identity map of  $M$ . Given  $p \in M$  let  $U$  be a neighborhood which is homeomorphic to  $\mathbb{R}^n$ , and let  $f: U \rightarrow \mathbb{R}^n$  be a specific homeomorphism. Define

$$h: U \times U \rightarrow U \times \mathbb{R}^n$$

by  $h(a, b) = (a, f(b) - f(a))$ . It is clear that  $h$  is a homeomorphism, and that the diagram



is commutative. This proves that  $t_M$  is a microbundle.

If  $M$  happens to be a smooth ( $= C^\infty$ ) manifold, note that one has two radically different concepts of tangent bundle. These will be compared in Theorem (2.2) below.

The concept of isomorphism between two microbundles  $\alpha_1$  and  $\alpha_2$  over the same base space is defined as follows. Let  $\alpha_\alpha$  have diagram  $B \xrightarrow{i_\alpha} E_\alpha \xrightarrow{j_\alpha} B$  for  $\alpha = 1, 2$ .

DEFINITION.  $\alpha_1$  is isomorphic to  $\alpha_2$  if there exist neighborhoods  $V_1$  of  $i_1 B$  in  $E_1$  and  $V_2$  of  $i_2 B$  in  $E_2$ , and a homeomorphism  $V_1 \rightarrow V_2$  so that the following diagram is commutative.

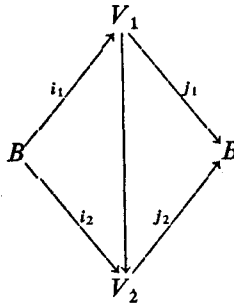

The notation  $\alpha_1 \cong \alpha_2$  will be used for this relation of isomorphism.

A microbundle over  $B$  will be called *trivial* if it is isomorphic to the standard trivial microbundle  $c_B^n$ . A manifold  $M$  will be called *topologically parallelizable* if the tangent microbundle  $t_M$  is trivial.

The following theorem will provide a basic transition between the theory of microbundles and the theory of vector bundles.

THEOREM (2.2). Let  $M$  be a smooth paracompact manifold with tangent vector bundle  $\tau$ . Then the underlying microbundle  $|\tau|$  is isomorphic to the tangent microbundle of  $M$ .

*Proof.* Since  $M$  is paracompact, it possesses a Riemannian metric. Let  $E(\tau)$  be the total space, consisting of all pairs  $(p, v)$  with  $p \in M$  and  $v$  in the tangent vector space to  $M$  at  $p$ ; and let  $i : M \rightarrow E(\tau)$  be the zero cross-section:  $i(p) = (p, 0)$ . As usual let  $\exp(p, v) \in M$  denote the endpoint  $g(1)$  of the unique geodesic

$$g : [0, 1] \rightarrow M$$

satisfying the initial conditions

$$g(0) = p, \quad \frac{dg}{dt}(0) = v.$$

(Here  $\frac{dg}{dt}$  denote the velocity vector of  $g$ .)

If  $M$  happens to be geodesically complete then  $\exp(p, v)$  is defined for all  $(p, v) \in E(\tau)$ . In general, however,  $\exp(p, v)$  can only be defined for  $(p, v)$  belonging to some neighborhood  $E'$  of the subset  $i(M) \subset E(\tau)$ . Define the smooth map  $h: E' \rightarrow M \times M$  by  $h(p, v) = (p, \exp(p, v))$ . Using the inverse function theorem one sees, for each  $(p, 0) \in i(M)$ , that  $h$  carries some neighborhood of  $(p, 0)$  in  $E'$  diffeomorphically onto a neighborhood of  $(p, p) \in M \times M$ . (Compare [16, §10.3].) Now it follows by an argument in point-set topology that  $h$  maps some neighborhood  $E''$  of  $i(M) \subset E'$  diffeomorphically onto a neighborhood  $V$  of the diagonal in  $M \times M$ . (Compare J. H. C. Whitehead [26, §4].) Since the diagram

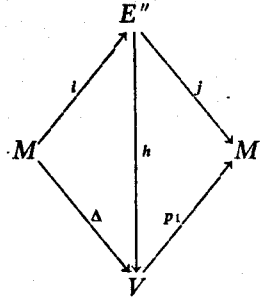

is commutative, this proves that  $|\tau|$  is isomorphic to  $t_M$ .

To conclude this section we provide a sharper description of trivial microbundles.

LEMMA (2.3). *Let  $\varkappa$  be a trivial microbundle over a paracompact base space  $B$ . Then some open subset of  $E(\varkappa)$  is homeomorphic to all of  $B \times \mathbb{R}^n$  (rather than to an open subset of  $B \times \mathbb{R}^n$ ); the homeomorphism being compatible with injection and projection maps.*

*Proof.* Without loss of generality we may assume that  $E(\varkappa)$  is an open subset of  $B \times \mathbb{R}^n$ . Using a partition of unity, construct a map  $\lambda: B \rightarrow (0, 1]$  so that every point  $(b, x) \in B \times \mathbb{R}^n$  with  $|x| < \lambda(b)$  belongs to  $E(\varkappa)$ . (Here  $|x|$  stands for  $(x_1^2 + \dots + x_n^2)^{1/2}$ .) Now the homeomorphism

$$(b, x) \rightarrow (b, x/(\lambda(b) - |x|))$$

maps the open set  $\{(b, x): |x| < \lambda(b)\}$  homeomorphically onto  $B \times \mathbb{R}^n$ . This completes the proof.

### §3. INDUCED MICROBUNDLES

Many of the standard constructions for vector bundles carry over immediately to microbundles. Thus if  $\varkappa$  denotes the microbundle

$$B \xrightarrow{i} E \xrightarrow{j} B$$

and if  $A$  is a subset of  $B$  then one can define the *restricted microbundle*  $\varkappa|A$  to be the diagram

$$A \xrightarrow{i'} j'^{-1}A \xrightarrow{j'} A$$

where  $i' = i|_A$ ,  $j' = j|_{j^{-1}A}$ . [With this terminology the 'local triviality' condition can be restated as follows: Every point of  $B$  has a neighborhood  $U$  so that  $\mathfrak{x}|_U$  is trivial.]

More generally let  $A$  be an arbitrary topological space, and let  $f: A \rightarrow B$  be a mapping. Then the induced microbundle  $f^*\mathfrak{x}$  is defined to be the diagram

$$A \xrightarrow{i'} E' \xrightarrow{p_1} A$$

where  $E' \subset A \times E$  is the set of all pairs  $(a, e)$  with  $f(a) = j(e)$ ; and where

$$i'(a) = (a, if(a)), \quad p_1(a, e) = a.$$

Local triviality is easily verified.

If  $f$  happens to be an inclusion map, note that  $f^*\mathfrak{x} \cong \mathfrak{x}|_A$ .

The following basic theorem will be proved in §6. Let  $\mathfrak{x}$  be a microbundle over  $B$ , and let  $f$  and  $g$  be maps from  $A$  to  $B$ .

**HOMOTOPY THEOREM (3.1).** *If  $A$  is paracompact and if  $f$  is homotopic to  $g$ , then  $f^*\mathfrak{x} \cong g^*\mathfrak{x}$ .*

As an immediate consequence one has:

**COROLLARY (3.2).** *If  $B$  is paracompact and contractible, then any microbundle over  $B$  is trivial.*

Another useful consequence is the following. Given  $f: A \rightarrow B$  let  $B \cup_f CA$  denote the space obtained from  $B$  by attaching the cone

$$CA = A \times [0, 1] / A \times [0]$$

to  $B$ ; identifying each  $(a, 1)$  in  $A \times [1]$  with  $f(a) \in B$ . Assume that  $A$  is paracompact.

**LEMMA (3.3).** *A microbundle  $\mathfrak{x}$  over  $B$  can be extended to a microbundle over  $B \cup_f CA$  if and only if  $f^*\mathfrak{x}$  is trivial.*

*Proof.* The composition  $A \xrightarrow{f} B \subset B \cup_f CA$  is null-homotopic. Hence if  $\mathfrak{x}$  extends it follows that  $f^*\mathfrak{x}$  is trivial.

To prove that converse, consider the mapping cylinder  $M = B \cup_f (A \times [0, 1])$  of  $f$ . (Each pair  $(a, 1) \in A \times [1]$  is to be identified with  $f(a) \in B$ .) Since  $B$  is a retract of  $M$  it follows that  $\mathfrak{x}$  can be extended to a microbundle  $\mathfrak{x}_1$  over  $M$ . Now suppose that  $f^*\mathfrak{x}$  is trivial. Then  $\mathfrak{x}_1|_{A \times [0]}$  is also trivial. Clearly this implies that  $\mathfrak{x}_1|_{A \times [0, \frac{1}{2}]}$  is trivial.

According to §2.3 this means that some open subset of  $E(\mathfrak{x}_1|_{A \times [0, \frac{1}{2}]})$  is homeomorphic to  $A \times [0, \frac{1}{2}] \times \mathbf{R}^n$ . After removing a closed subset of  $E(\mathfrak{x}_1)$ , if necessary, we may assume that  $E(\mathfrak{x}_1|_{A \times [0, \frac{1}{2}]})$  itself is homeomorphic to  $A \times [0, \frac{1}{2}] \times \mathbf{R}^n$ ; the homeomorphism  $h$  being compatible with injections and projections.

The space  $B \cup_f CA$  can be obtained from  $M$  by collapsing  $A \times [0]$  to a point. Let  $E(x_2)$  be obtained from  $E(x_1)$  by collapsing  $h^{-1}(A \times [0] \times \{x\})$  to a point for each  $x \in \mathbf{R}^n$ . Then evidently  $E(x_2)$  is the total space of the required microbundle over  $B \cup_f CA$ .

§4. THE GROUP  $k_{\text{Top}}B$ 

Let  $x$  and  $x'$  be two microbundles over the same base space. The *Whitney sum*  $x \oplus x'$  is defined just as for vector bundles. Thus the total space  $E(x \oplus x')$  is the subset of  $E(x) \times E(x')$  consisting of all pairs  $(e, e')$  with  $j(e) = j'(e')$ . The injection and projection maps

$$B \rightarrow E(x \oplus x') \rightarrow B$$

are defined by  $b \rightarrow (i(b), i'(b))$  and  $(e, e') \rightarrow j(e)$  respectively. Local triviality is easily verified. This sum operation is associative and commutative up to isomorphism.

Alternatively one can first define the Cartesian product operation. Given microbundles  $x_1$  and  $x_2$  over distinct base spaces let  $x_1 \times x_2$  be the microbundle with diagram

$$B(x_1) \times B(x_2) \xrightarrow{i_1 \times i_2} E(x_1) \times E(x_2) \xrightarrow{j_1 \times j_2} B(x_1) \times B(x_2).$$

Now  $x \oplus x'$  can be defined as  $\Delta^*(x \times x')$ , where  $\Delta: B \rightarrow B \times B$  denotes the diagonal map. This  $x \oplus x'$  is isomorphic to the previously defined  $x \oplus x'$ .

The following theorem will be of fundamental importance.

By a 'simplicial complex' we will mean a possibly infinite simplicial complex with the direct limit topology (= fine topology).

**THEOREM (4.1).** *Let  $x$  be a microbundle over a finite dimensional simplicial complex  $B$ . Then there exists a microbundle  $\eta$  over  $B$  so that the Whitney sum  $x \oplus \eta$  is trivial.*

The proof will be based on the following lemma, whose proof will be deferred until §7.7.

**LEMMA (4.2).** *Suppose that the CW-complex  $B$  is a 'bouquet' of finitely or infinitely many spheres, meeting at a single point. Let  $r: B \rightarrow B$  map each sphere into itself with degree  $-1$ . Then for any  $x$  over  $B$  the sum  $x \oplus r^*x$  is trivial.*

Assuming this result, the proof of (4.1) proceeds by induction on the dimension  $d$  of  $B$ , as follows.

*Start of Induction.* If  $d = 0$  then  $x$  itself is trivial and there is nothing to prove. If  $d = 1$  then each component of  $B$  has the homotopy type of a bouquet of circles, so the assertion follows from (4.2).

*Inductive step.* Let  $B'$  denote the  $(d-1)$ -skeleton of  $B$ . Assume by induction that there exists a microbundle  $\eta'$  over  $B'$  so that  $(x|_{B'}) \oplus \eta'$  is trivial.

Let  $e^n$  be the trivial microbundle over  $B'$ , where  $n$  is the fibre dimension of  $x$ . We will first see that  $\eta' \oplus e^n$  extends to some microbundle  $\zeta$  over  $B$ . Clearly a microbundle over  $B'$  can be extended over a given  $d$ -simplex  $\sigma$  if and only if its restriction to the boundary  $\partial\sigma$  is trivial. (Compare §3.3.) Thus  $x|_{\partial\sigma}$  is trivial. Hence  $(\eta' \oplus e^n)|_{\partial\sigma}$  is isomorphic to  $(\eta' \oplus x)|_{\partial\sigma}$  which is known to be trivial. Therefore the microbundle  $\eta' \oplus e^n$  can be extended over each  $d$ -simplex  $\sigma$ .

In order to extend  $\eta' \oplus e^n$  simultaneously over all the  $d$ -simplexes of  $B$ , a little more care is needed. Let  $B''$  be obtained from  $B$  by removing a small open  $d$ -cell in each  $d$ -simplex. Since  $B'$  is a retract of  $B''$ , it is clear that  $\eta' \oplus e^n$  extends over  $B''$ . Now the 'holes' in  $B''$

are well separated from each other so that there is no further difficulty in constructing the required extension  $\mathfrak{z}$  over  $B$  itself.

Consider the complex  $B \cup CB'$  obtained from  $B$  by adjoining a cone over the  $(d-1)$ -skeleton  $B'$ . Since  $(\mathfrak{x} \oplus \mathfrak{z})|_{B'}$  is trivial, it follows by (3.3) that  $\mathfrak{x} \oplus \mathfrak{z}$  extends to some microbundle  $w$  over  $B \cup CB'$ . But  $B \cup CB'$  has the homotopy type of a bouquet of  $d$ -spheres. Hence there exists a microbundle  $r^*w$  over  $B \cup CB'$  so that  $w \oplus r^*w$  is trivial. Now  $\mathfrak{x} \oplus \mathfrak{z} \oplus (r^*w|_B)$  is trivial, which completes the induction.

*Remark.* A short computation shows that the microbundle  $\mathfrak{y} = \mathfrak{z} \oplus (r^*w|_B)$  constructed in this way has fibre dimension  $n(2^{d+1} - 3)$ . This number seems extravagantly large, but at least one has a specific estimate.

**DEFINITION.** Two microbundles  $\mathfrak{x}$  and  $\mathfrak{x}'$  over  $B$  belong to the same  $s$ -class if  $\mathfrak{x} \oplus \mathfrak{e}_B^q$  is isomorphic to  $\mathfrak{x}' \oplus \mathfrak{e}_B^r$  for some integers  $q, r$ . We will also say that  $\mathfrak{x}$  is  $s$ -isomorphic to  $\mathfrak{x}'$ . The  $s$ -class of  $\mathfrak{x}$  will be denoted by  $(\mathfrak{x})$ .

As an immediate consequence of Theorem (4.1) we have:

**COROLLARY (4.3).** The  $s$ -classes of microbundles over a finite dimensional complex  $B$  form an abelian group under the composition operation  $(\mathfrak{x}) + (\mathfrak{y}) = (\mathfrak{x} \oplus \mathfrak{y})$ .

The proof is straightforward.

**DEFINITION.** This group will be denoted by  $\mathbf{k}_{\text{Top}}B$ .

Note that  $\mathbf{k}_{\text{Top}}$  is a contravariant functor. That is any map  $f: A \rightarrow B$  gives rise to a homomorphism

$$f^*: \mathbf{k}_{\text{Top}}B \rightarrow \mathbf{k}_{\text{Top}}A,$$

which depends only on the homotopy class of  $f$ . In particular if  $f: A \rightarrow B$  is a homotopy equivalence, it follows that  $f^*: \mathbf{k}_{\text{Top}}B \rightarrow \mathbf{k}_{\text{Top}}A$  is an isomorphism.

Thus  $\mathbf{k}_{\text{Top}}$  behaves somewhat like a cohomology theory. This analogy is brought out by the following. Let  $SB$  denote the suspension of  $B$ , and let  $B \underset{f}{\cup} CA$  denote the space obtained from  $B$  by attaching the cone over  $A$ , using the attaching map  $f$ .

**LEMMA (4.4).** The half-infinite sequence

$$\dots \rightarrow \mathbf{k}_{\text{Top}}SB \xrightarrow{Sf^*} \mathbf{k}_{\text{Top}}SA \xrightarrow{c^*} \mathbf{k}_{\text{Top}}(B \underset{f}{\cup} CA) \xrightarrow{i^*} \mathbf{k}_{\text{Top}}B \xrightarrow{f^*} \mathbf{k}_{\text{Top}}A$$

is exact; where  $i: B \rightarrow B \underset{f}{\cup} CA$  is the inclusion map; and where  $c: B \underset{f}{\cup} CA \rightarrow SA$  collapses  $B$  to a point.

*Proof.* It follows from §3.3 that this sequence is exact at  $\mathbf{k}_{\text{Top}}B$ . Combining this fact with Puppe [17; Theorem 5, p. 310] one sees immediately that the entire sequence is exact.

In the theory of vector bundles, one constructs an analogous group consisting of  $s$ -classes of vector bundles over  $B$ . We will denote this group by  $\mathbf{k}_O B$  (where  $O$  stands for the orthogonal group). The analogues of assertions (4.1), (4.2), (4.3) and (4.4) for vector bundles are all true, and can be proved by similar or easier arguments.



The groups  $k_0 B$  have been much studied by Atiyah, Hirzebruch, Bott, Adams and others. (See references [1], [3], [5]. The first three use the notation  $\tilde{K}O(B)$  for this group; while Adams uses the notation  $\tilde{K}_R(B)$ . Our  $k$  is to be thought of as an abbreviation for  $\tilde{K}$ .)

There is a natural transformation  $k_0 B \rightarrow k_{\text{Top}} B$  which carries each  $s$ -class ( $\xi$ ) to the  $s$ -class ( $|\xi|$ ) of its underlying microbundle. This will play an important role in what follows. The word 'natural' means that for each  $f: A \rightarrow B$  the following diagram commutes:

$$\begin{array}{ccc} k_0 B & \longrightarrow & k_{\text{Top}} B \\ \downarrow f^* & & \downarrow f^* \\ k_0 A & \longrightarrow & k_{\text{Top}} A \end{array}$$

## 5. NORMAL MICROBUNDLES AND THE SMOOTHING PROBLEM

Consider a submanifold  $M \subset N$ ; where  $M$  and  $N$  are topological manifolds of dimensions  $m$  and  $n$  respectively. We will always assume there is a countable basis for the topology of  $M$  and of  $N$ .

**DEFINITION.**  $M$  has a microbundle neighborhood in  $N$  if there exists a neighborhood  $U$  of  $M$  in  $N$  and a retraction  $j: U \rightarrow M$  so that the diagram

$$M \xrightarrow{\text{inclusion}} U \xrightarrow{j} M$$

constitutes a microbundle. This microbundle will be denoted by the letter  $\pi$ , and will be called a normal microbundle of  $M$  in  $N$ .

If  $M$  has a microbundle neighborhood in  $N$ , then it clearly follows that  $M$  is 'locally flat' in  $N$ . (Compare Brown [7]. As an example, it follows that a wild knot in 3-space cannot have a microbundle neighborhood.)

*Remark (1).* In general it is not known that  $M$  has a microbundle neighborhood in  $N$  even if  $M$  happens to be locally flat in  $N$ . However, in any case, we will see that  $M$  has a microbundle neighborhood in  $N \times \mathbb{R}^q$  for sufficiently large  $q$  (Theorem (5.8)). The proof will rely on ideas which are due to Curtis and Lashof [8].

*Remark (2).* Even if  $M$  does have a microbundle neighborhood, it is not known that the resulting normal microbundle  $\pi$  is unique up to isomorphism. However, we will prove that the Whitney sum  $t_M \oplus \pi$  is isomorphic to  $t_N|_M$ . This clearly implies that  $\pi$  is well defined up to  $s$ -isomorphism. (§5.10.)

One case of particular interest occurs if the neighborhood  $U$  and the retraction  $j$  can be chosen so that the microbundle  $\pi$  is trivial. In this case we will say that  $M$  has a *product neighborhood* in  $N$ . This phrase is justified as follows:

**LEMMA (5.1).** *A submanifold  $M \subset N$  has a microbundle neighborhood with  $\pi$  trivial if and only if, for some neighborhood  $U$  of  $M$ , the pair  $(U, M)$  is homeomorphic to  $M \times (\mathbb{R}_p^n, 0)$ .*

*Proof.* This follows from §2.3.

? (n-m)!

Now we will try to construct microbundle neighborhoods. The proof will be broken up into many small steps. First consider three manifolds  $M \subset N \subset P$ .

LEMMA (5.2). *If  $M$  has a microbundle neighborhood in  $N$ , and  $N$  has a microbundle neighborhood in  $P$ , then  $M$  has a microbundle neighborhood in  $P$ .*

The proof is straightforward. (Compare the proof of (5.9).)

We will make frequent use of the theorem that every manifold is an absolute neighborhood retract. See (Hanner [9], Theorem (3.3).) Thus, replacing  $N$  by some small neighborhood of  $M$  if necessary, we can always assume that there exists a retraction  $r: N \rightarrow M$ .

Let  $i: M \rightarrow N$  be the inclusion map. Then the tangent microbundle  $t_N$  restricts to a microbundle  $i^*t_N$  over  $M$ ; and conversely, using  $r$ , the tangent microbundle  $t_M$  can be lifted to  $N$ .

LEMMA (5.3). *The total space of the microbundle  $i^*t_N$  is homeomorphic to the total space of  $r^*t_M$ .*

Remark. This is one of the few occasions when it is important that a microbundle has a specific total space, rather than a vague equivalence class of total spaces.

Proof. By definition  $E(i^*t_N)$  is the set of pairs  $(x, (y, y'))$  in  $M \times (N \times N)$  with  $i(x) = y$ . Thus it is homeomorphic to  $M \times N$ . On the other hand  $E(r^*t_M)$  is the set of pairs  $(y, (x, x'))$  in  $N \times (M \times M)$  with  $r(y) = x$ . Thus it is homeomorphic to  $N \times M$ ; which completes the proof.

Note that the injection map  $M \rightarrow E(i^*t_N)$  corresponds under this homeomorphism to the injection map  $M \subset N \rightarrow E(r^*t_M)$ . Therefore Lemma (5.3) can be restated as follows:

LEMMA (5.4). *The submanifold  $M \subset N \subset E(r^*t_M)$  has a microbundle neighborhood; with  $\mathfrak{n} \cong i^*t_N$ .*

As a special case suppose that  $t_M$  is trivial. Then  $r^*t_M$  is also trivial; hence the total space  $E(r^*t_M)$  can be replaced by the total space  $N \times \mathbf{R}^m$  of the canonical trivial microbundle. This proves:

THEOREM (5.5). *If  $M$  is topologically parallelizable, then  $M \times 0$  has a microbundle neighborhood in  $N \times \mathbf{R}^m$ ; with normal microbundle  $\mathfrak{n} \cong i^*t_N$ .*

If  $t_N$  is also trivial, it follows that  $\mathfrak{n}$  is trivial. Thus:

COROLLARY (5.6). (Curtis and Lashof) *If  $M$  and  $N$  are both topologically parallelizable, then  $M \times 0$  has a product neighborhood in  $N \times \mathbf{R}^m$ .*

COROLLARY (5.7). *If  $M$  is a topologically parallelizable manifold, then the product  $M \times \mathbf{R}^{2m+1}$  can be imbedded as an open subset of  $\mathbf{R}^{3m+1}$ .*

Proof. Choose an imbedding of  $M$  in  $\mathbf{R}^{2m+1}$  (see [12, p. 60]) and apply (5.6).

We now return to the general case. Let  $M \subset N$  be arbitrary manifolds with countable basis.

THEOREM (5.8). *If the integer  $q$  is sufficiently large then  $M \times 0$  has a microbundle neighborhood in  $N \times \mathbf{R}^q$ .*

*Proof.* Choose a microbundle  $\eta$  over  $M$  so that the Whitney sum  $t_M \oplus \eta$  is trivial; say  $t_M \oplus \eta \cong \epsilon_M^q$ . This is possible (for large  $q$ ) since we can imbed  $M$  in  $\mathbb{R}^{2m+1}$  as a retract of some open neighborhood  $V$ , then extend  $t_M$  over  $V$ , and apply Theorem (4.1).

According to Lemma (5.4), the submanifold  $M \subset N \subset E(r^*t_M)$  has a microbundle neighborhood. Furthermore it is clear that the submanifold

$$E(r^*t_M) \subset E(r^*t_M \oplus r^*\eta)$$

has a microbundle neighborhood. Therefore, by Lemma (5.2), the submanifold  $M \subset E(r^*t_M \oplus r^*\eta)$  has a microbundle neighborhood. But  $r^*t_M \oplus r^*\eta$  is trivial. Therefore we can replace  $E(r^*t_M \oplus r^*\eta)$  by  $N \times \mathbb{R}^q$  without changing this conclusion. This completes the proof that  $M = M \times 0$  has a microbundle neighborhood in  $N \times \mathbb{R}^q$ .

*Remark.* To be more specific this argument works providing that  $q \geq m(2^{2m+2} - 2)$ , where  $m$  is the dimension of  $M$ . In special cases it is possible to reduce this estimate substantially. (Compare (5.5).) Thus if  $t_M \cong |\zeta|$  for some vector bundle  $\zeta$ , then one can show that  $M \times 0$  has a microbundle neighborhood in  $N \times \mathbb{R}^{2m}$ .

Now let us study the extent to which a normal microbundle is unique. Consider a submanifold  $M \subset N$  with normal microbundle  $\eta$ .

**THEOREM (5.9).** *The Whitney sum  $t_M \oplus \eta$  is isomorphic to  $t_N|_M$ .*

The proof will depend on the following construction. Let  $\alpha$  and  $\eta$  be two microbundles, with diagrams

$$B \rightarrow E \rightarrow B \quad \text{and} \quad E \rightarrow E' \rightarrow E$$

respectively, such that the total space of  $\alpha$  is equal to the base space of  $\eta$ . Then the composition  $\alpha \circ \eta$  is defined to be the microbundle

$$B \rightarrow E' \rightarrow B$$

having the composition of injection maps as injection, and the composition of projection maps as projection.

*Example (1).* Consider the two microbundles  $t_M$  and  $p_2^*\eta$ ; where  $p_2: M \times M \rightarrow M$  denotes the projection to the second factor. Then it is not difficult to see that the composition  $t_M \circ p_2^*\eta$  is defined; and is isomorphic to  $t_N|_M$ .

*Example (2).* Similarly we can compose  $t_M$  with  $p_1^*\eta$ . In this case, since  $p_1$  is the projection map of  $t_M$ , it is easily seen that  $t_M \circ p_1^*\eta \cong t_M \oplus \eta$ .

Let  $D$  be a neighborhood of the diagonal in  $M \times M$  which is so small that the mapping  $p_1|_D$  is homotopic to  $p_2|_D$ . [Such a neighborhood can be constructed as follows: Imbed  $M$  as a retract of a neighborhood  $V$  in some Euclidean space; and let  $D$  be the set of pairs  $(x, x')$  in  $M \times M$  such that the line segment from  $x$  to  $x'$  lies completely within  $V$ .]

It follows that the restricted microbundle  $p_1^*\eta|_D$  is isomorphic to  $p_2^*\eta|_D$ . Let  $t'_M$  denote the microbundle  $M \xrightarrow{\Delta} D \xrightarrow{p_1|_D} M$  (which is of course isomorphic to  $t_M$ ). Then

$$t_M \circ p_1^*\eta \cong t'_M \circ (p_1^*\eta|_D) \cong t'_M \circ (p_2^*\eta|_D) \cong t_M \circ p_2^*\eta.$$

Therefore  $t_M \oplus \eta \cong t_N|_M$ ; which completes the proof.

Passing to the group  $k_{\text{Top}}M$  of  $s$ -classes, it follows that

$$(t_M) + (n) = i^*(t_N),$$

or in other words that  $(n) = i^*(t_N) - (t_M)$ . Thus:

**COROLLARY (5.10)** *If the normal microbundle  $n$  exists, then it is uniquely determined up to  $s$ -isomorphism.*

**COROLLARY (5.11)** *The submanifold  $M \times 0 \subset N \times \mathbb{R}^q$  has a product neighborhood, for sufficiently large values of  $q$ , if and only if  $(t_M) = i^*(t_N)$ .*

*Proof.* If  $M \times 0 \subset N \times \mathbb{R}^q$  has normal microbundle  $n$  with  $(n) = 0$ , then there exists an integer  $r$  so that  $n \oplus e^r$  is trivial. It follows that  $M \times 0 \subset N \times \mathbb{R}^{q+r}$  has a product neighborhood.

Now let us consider the problem of imposing a smoothness structure on a given manifold  $M$ . If we are willing to replace  $M$  by some product  $M \times \mathbb{R}^q$ , then a solution can be given as follows:

**THEOREM (5.12)** *Let  $M$  be a topological manifold. The product  $M \times \mathbb{R}^q$  can be given a smoothness structure, for sufficiently large values of  $q$ , if and only if  $t_M$  is  $s$ -isomorphic to  $|\xi|$  for some vector bundle  $\xi$  over  $M$ .*

*Proof.* If  $M \times \mathbb{R}^q$  can be given a smoothness structure with tangent bundle  $\tau$ , then

$$t_{M \times \mathbb{R}^q} \cong t_M \times t_{\mathbb{R}^q} \cong |\tau|$$

hence  $t_M \oplus e_M^q$  is isomorphic to  $|\tau|$  restricted to  $M$ .

Conversely suppose that  $t_M$  is  $s$ -isomorphic to  $|\xi|$ . Imbed  $M$  as a retract of some neighborhood  $V$  in the Euclidean space  $\mathbb{R}^{2m+1}$ . Then  $\xi$  extends to a vector bundle  $\xi'$  over  $V$ . We may give  $\xi'$  the structure of a smooth vector bundle. To do this it is only necessary to observe that there exists a bundle map from  $\xi'$  to the universal bundle over some Grassmann manifold  $G_m(\mathbb{R}^l)$ . Now approximating the resulting function  $V \rightarrow G_m(\mathbb{R}^l)$  by a smooth map, we obtain a smooth induced bundle which is isomorphic to  $\xi'$ .

Thus the total space  $E = E(\xi')$  is a smooth manifold. Now consider the injection map  $M \subset V \rightarrow E$ . Evidently  $\tau_V \oplus \xi' \cong \tau_E|_V$ . Restricting to  $M$ , this means that  $\varepsilon^{2m+1} \oplus \xi \cong \tau_E|M$ . Therefore the tangent microbundle of  $E$ , restricted to  $M$ , is isomorphic to  $\varepsilon^{2m+1} \oplus |\xi|$ , which is  $s$ -isomorphic to  $t_M$ . By Corollary (5.11) this implies that  $M \times 0$  has a product neighborhood in  $E \times \mathbb{R}^s$  for large  $s$ . Therefore  $M \times \mathbb{R}^q$  can be imbedded as an open subset of the smooth manifold  $E \times \mathbb{R}^s$ ; where  $q = \dim E + s - m$ . Evidently  $M \times \mathbb{R}^q$  inherits a smoothness structure; which completes the proof.

It is easily verified that the tangent bundle  $\tau$  of this smooth manifold  $M \times \mathbb{R}^q$  is isomorphic to  $\xi \times \varepsilon^{2m+1+s}$ . Thus our theorem can be sharpened as follows.

**SMOOTHING THEOREM (5.13).** *Let  $\xi$  be a vector bundle over the topological manifold  $M$ . Then some product  $M \times \mathbb{R}^q$  can be smoothed so as to have tangent bundle isomorphic to  $\xi \times \varepsilon^q$  if and only if the homomorphism  $k_0 M \rightarrow k_{\text{Top}} M$  carries  $(\xi)$  to  $(t_M)$ .*

### §6. BUNDLE MAP-GERMS AND THE HOMOTOPY THEOREM

Before starting the proof of the (covering) homotopy theorem (§3.1) it is necessary to introduce several new concepts, and to prove several lemmas. Let  $X \supset A$  and  $Y \supset B$  be topological spaces.

**DEFINITION (6.1).** *A map-germ from  $(X, A)$  to  $(Y, B)$  is an equivalence class of mappings  $f$ , each defined on some neighborhood  $U_f$  of  $A$  in  $X$ , and mapping the pair  $(U_f, \dot{A})$  into  $(Y, B)$ . Two such maps  $f, f'$  are equivalent (i.e. give rise to the same map-germ) if and only if  $f|V = f'|V$  for some sufficiently small neighborhood  $V$  of  $A$ . The notation*

$$F : (X, A) \Rightarrow (Y, B)$$

will be used for such a map-germ.

The composition  $GF$  of two map-germs

$$(X, A) \xRightarrow{F} (Y, B) \xRightarrow{G} (Z, C)$$

is readily defined.  $F$  will be called a *homeomorphism-germ* if it possesses a two-sided inverse  $G : (Y, B) \Rightarrow (X, A)$ . Clearly  $F$  is a homeomorphism-germ if and only if a representative map  $f$  carries some neighborhood of  $A$  homeomorphically onto a neighborhood of  $B$ .

Now consider a microbundle  $\mathfrak{x}$  over  $B$ . The projection map  $j : E \rightarrow B$  determines a map-germ  $(E, iB) \Rightarrow (B, B)$  which will be denoted by  $J$ , and called the *projection-germ* of  $\mathfrak{x}$ . It will be convenient to simplify the notation in two ways:

- (1) The pair  $(B, B)$  will be denoted briefly by  $B$ .
- (2) The space  $B$  will be identified with its image  $iB \subset E$ .

With these conventions we may write simply

$$J : (E, B) \Rightarrow B$$

for the projection-germ.

Let  $\mathfrak{x}'$  be a second microbundle over  $B$  with projection-germ  $J' : (E', B) \Rightarrow B$ .

**DEFINITION (6.2).** *An isomorphism-germ from  $\mathfrak{x}$  to  $\mathfrak{x}'$  is a homeomorphism-germ*

$$F : (E, B) \Rightarrow (E', B)$$

which is fibre-preserving, in the sense that  $J'F = J$ .

Clearly there exists such an isomorphism-germ if and only if  $\mathfrak{x}$  is isomorphic to  $\mathfrak{x}'$  (in the sense of §2).

More generally consider a microbundle  $\mathfrak{x}'$  over a different base space  $B'$ . The fibre dimensions of  $\mathfrak{x}$  and  $\mathfrak{x}'$  should be the same. Let  $F : (E, B) \Rightarrow (E', B')$  be a map-germ, with representative map  $f : U_f \rightarrow E'$ .

DEFINITION (6.3).  $F$  will be called a bundle map-germ from  $\mathfrak{x}$  to  $\mathfrak{x}'$  if there exists a neighborhood  $V$  of  $B$  in  $U_f$  so that  $f$  maps each fibre  $j^{-1}(b) \cap V$  in one-one fashion into some fibre  $j'^{-1}(b')$  of  $\mathfrak{x}'$ .

The notation  $F: \mathfrak{x} \Rightarrow \mathfrak{x}'$  will also be used. I am indebted to R. Williamson for this concept of bundle map.

It follows that the following diagram commutes:

$$\begin{array}{ccc} (E, B) & \xrightarrow{F} & (E', B') \\ \downarrow J & & \downarrow J' \\ B & \xrightarrow{F|B} & B' \end{array}$$

We will say that the mapping  $F|B$  is covered by the bundle map-germ  $F$ .

The following lemma helps to justify this definition:

LEMMA (6.4). (Williamson) Suppose that  $B = B'$ , and let  $F$  be a bundle map-germ from  $\mathfrak{x}$  to  $\mathfrak{x}'$  which covers the identity map of  $B$ . Then  $F$  is an isomorphism-germ.

*Proof.* First consider the following very special case. Consider a map

$$g: B \times \mathbf{R}^n \rightarrow B \times \mathbf{R}^n$$

which is one-one and fibre preserving. In other words assume that  $g$  can be expressed in the form

$$g(b, x) = (b, g_b(x))$$

where each  $g_b: \mathbf{R}^n \rightarrow \mathbf{R}^n$  is one-one. It follows from the theorem of invariance of domain that each  $g_b$  is an open mapping. (See [12, p. 95].) We will show that  $g$  itself is an open mapping. This will imply that  $g$  maps  $B \times \mathbf{R}^n$  homeomorphically onto an open subset of itself.

Let  $N_\varepsilon(x)$  denote the closed ball of radius  $\varepsilon$  centered at the point  $x \in \mathbf{R}^n$ . For any  $(b_0, x_0) \in B \times \mathbf{R}^n$  and any  $\varepsilon > 0$  note that  $g_{b_0}N_\varepsilon(x_0)$  is a neighborhood of the image point  $x_1 = g_{b_0}(x_0)$ . Choose  $\delta > 0$  so that

$$N_{2\delta}(x_1) \subset g_{b_0}N_\varepsilon(x_0).$$

Let  $V$  be a neighborhood of  $b_0$  which is so small that

$$|g_b(x) - g_{b_0}(x)| < \delta$$

for all  $x \in N_\varepsilon(x_0)$  and all  $b \in V$ . Such a neighborhood exists since  $N_\varepsilon(x_0)$  is compact. Now for each  $b \in V$  it can be seen that the image  $g_bN_\varepsilon(x_0)$  contains the smaller ball  $N_\delta(x_1)$ . Therefore

$$g(V \times N_\varepsilon(x_0)) \supset V \times N_\delta(x_1);$$

which proves that  $g$  is an open mapping.

Now let  $\mathfrak{x}$  and  $\mathfrak{x}'$  be microbundles over  $B$  and let  $F: \mathfrak{x} \Rightarrow \mathfrak{x}'$  cover the identity map of  $B$ . Let  $f: U \rightarrow U'$  be a representative map for  $F$ . By choosing  $U$  sufficiently small we may assume that  $f$  is one-one and fibre preserving.

Since microbundles are locally trivial, the argument given above can be applied locally. For each  $b \in B$  it follows that there is a neighborhood  $W_b$  of  $i(b)$  in  $U$  such that  $f$  maps  $W_b$  homeomorphically onto an open set  $f(W_b) \subset E'$ . Taking  $W = \cup W_b$  it follows immediately that  $f$  maps  $W$  homeomorphically onto the open set  $f(W)$ . Therefore  $F$  is a homeomorphism-germ. This completes the proof of Lemma (6.4).

**COROLLARY (6.5).** *If a map  $g: B \rightarrow B'$  is covered by a bundle map-germ  $\mathfrak{x} \Rightarrow \mathfrak{x}'$  then  $\mathfrak{x}$  is isomorphic to the induced bundle  $g^*\mathfrak{x}'$ .*

The proof is easily supplied.

The next lemma asserts that bundle maps can be 'pieced together'.

**LEMMA (6.6).** *Let  $\mathfrak{x}$  be a microbundle over  $B$  and let  $\{B_\alpha\}$  be a locally finite collection of closed sets covering  $B$ . Suppose that one is given bundle map-germs*

$$F_\alpha : \mathfrak{x}|B_\alpha \Rightarrow \eta$$

*such that  $F_\alpha$  coincides with  $F_\beta$  on  $\mathfrak{x}|B_\alpha \cap B_\beta$  for each  $\alpha, \beta$ . Then there exists a bundle map-germ  $F : \mathfrak{x} \Rightarrow \eta$  which extends the  $F_\alpha$ .*

*Proof.* Let  $f_\alpha : U_\alpha \rightarrow E'$  be a representative map for  $F_\alpha$ . Suppose that  $f_\alpha$  coincides with  $f_\beta$  on a set  $U_{\alpha\beta}$  which is an open neighborhood of  $B_\alpha \cap B_\beta$  in  $U_\alpha \cap U_\beta$ . Let  $U$  be the set consisting of all  $e \in E$  such that, for each  $\alpha, \beta$ :

- (1) if  $j(e) \in B_\alpha$  then  $e \in U_\alpha$ , and
- (2) if  $j(e) \in B_\alpha \cap B_\beta$  then  $e \in U_{\alpha\beta}$ .

Since  $\{B_\alpha\}$  is a locally finite closed covering, the set  $U$  is open. Clearly the  $f_\alpha$  piece together to yield a map

$$f : U \rightarrow E'$$

which represents the required bundle map-germ.

We are now ready to begin the proof of the homotopy theorem.

**LEMMA (6.7).** *Let  $\mathfrak{x}$  be a microbundle over the product  $B \times [0, 1]$  such that both  $\mathfrak{x}|B \times [0, \frac{1}{2}]$  and  $\mathfrak{x}|B \times [\frac{1}{2}, 1]$  are trivial. Then  $\mathfrak{x}$  itself is trivial.*

*Proof.* Since  $\mathfrak{x}|B \times [\frac{1}{2}, 1]$  is trivial it follows that the identity bundle map-germ of  $\mathfrak{x}|B \times [\frac{1}{2}, 1]$  can be extended to a map-germ

$$\mathfrak{x}|B \times [\frac{1}{2}, 1] \Rightarrow \mathfrak{x}|B \times [\frac{1}{2}, 1].$$

Piecing this together with the identity map-germ of  $\mathfrak{x}|B \times [0, \frac{1}{2}]$ , by Lemma (6.6), this yields a map-germ

$$\mathfrak{x} \Rightarrow \mathfrak{x}|B \times [0, \frac{1}{2}].$$

But the latter bundle is trivial, hence  $\mathfrak{x}$  itself is trivial.

**LEMMA (6.8).** *Let  $\mathfrak{x}$  be any microbundle over  $B \times [0, 1]$ . Then each  $b \in B$  has a neighborhood  $V$  so that  $\mathfrak{x}|V \times [0, 1]$  is trivial.*

*Proof.* For each  $t \in [0, 1]$  choose a neighborhood  $V_t \times (t - \varepsilon_t, t + \varepsilon_t)$  of  $(b, t)$  so that  $\mathfrak{x}$  restricted to this neighborhood is trivial. The compact set  $b \times [0, 1]$  is covered by finitely

many such neighborhoods. Let  $V$  be the intersection of the corresponding neighborhoods  $V_i$ . Then there exists a subdivision  $0 = t_0 < t_1 < t_2 < \dots < t_k = 1$  so that each  $\pi|V \times [t_{i-1}, t_i]$  is trivial. Applying Lemma (6.7) inductively, it follows that  $\pi|V \times [0, 1]$  is trivial.

LEMMA (6.9). Let  $\pi$  be a microbundle over  $B \times [0, 1]$ , where  $B$  is paracompact. Then the standard retraction

$$r : B \times [0, 1] \rightarrow B \times [1]$$

is covered by a bundle map-germ  $\pi \Rightarrow \pi|B \times [1]$ .

Proof. Let  $\{V_\alpha\}$  be a locally finite covering of  $B$  by open sets  $V_\alpha$  such that  $\pi|V_\alpha \times [0, 1]$  is trivial. Choose continuous real valued functions

$$\lambda_\alpha : B \rightarrow [0, 1]$$

so that the support of each  $\lambda_\alpha$  is contained in  $V_\alpha$ , and so that

$$\text{Max}_\alpha \lambda_\alpha(b) = 1$$

for each  $b \in B$ . Now define a retraction  $r_\alpha$  of  $B \times [0, 1]$  into itself by

$$r_\alpha(b, t) = (b, \text{Max}(t, \lambda_\alpha(b))).$$

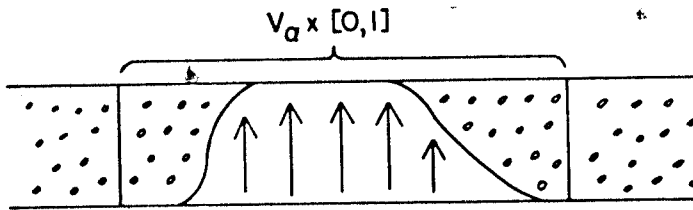

FIG. 3.

(This is represented schematically in Fig. 3, where the curved line represents the graph of  $\lambda_\alpha$ .) Note that the 'composition' of the infinitely many retractions  $r_\alpha$  is just

$$r(b, t) = (b, 1).$$

Each  $r_\alpha$  is covered by a bundle map-germ  $R'_\alpha : \pi \Rightarrow \pi$  as follows. Express  $B \times [0, 1]$  as the union of the two closed sets

$$A_\alpha = (\text{Support } \lambda_\alpha) \times [0, 1],$$

$$A'_\alpha = \{(b, t) : t \geq \lambda_\alpha(b)\}.$$

Since  $\pi|A_\alpha$  is trivial, the identity map-germ of  $\pi|A_\alpha \cap A'_\alpha$  extends to a bundle map-germ

$$\pi|A_\alpha \Rightarrow \pi|A_\alpha \cap A'_\alpha$$

which covers  $r_\alpha|A_\alpha$ . Piecing this together with the identity map-germ of  $\pi|A'_\alpha$  (using Lemma (6.6)), we obtain the required map-germ  $R_\alpha$ .

Choose some fixed ordering of the index set  $\{\alpha\}$ . The required bundle map-germ

$$R : \pi \Rightarrow \pi|B \times [1]$$



will now be defined as the 'composition' of all of the  $R_{\alpha}$ , in the prescribed order. This will make sense since, locally, all but a finite number of the  $R_{\alpha}$  are the identity.

To be more precise let  $\{B_{\beta}\}$  be a locally finite covering of  $B$  by closed sets, such that each  $B_{\beta}$  intersects only finitely many  $V_{\alpha}$ . Suppose that  $B_{\beta}$  intersects only  $V_{\alpha_1}, \dots, V_{\alpha_k}$  where  $\alpha_1 < \alpha_2 < \dots < \alpha_k$ . Then the composition  $R_{\alpha_1} R_{\alpha_2} \dots R_{\alpha_k}$  restricts to a map-germ  $R(\beta): \mathfrak{x}|_{B_{\beta}} \times [0, 1] \Rightarrow \mathfrak{x}|_{B_{\beta}} \times [1]$ . Piecing together the  $R(\beta)$  by (6.6) we obtain the required bundle map-germ  $R$ .

The homotopy theorem (§3.1) now follows easily. Let  $f_0, f_1: B \rightarrow B'$  be two maps which are homotopic under a homotopy  $f: B \times [0, 1] \rightarrow B'$ ; and let  $\eta$  be a microbundle over  $B'$ . By (6.9) there exists a map-germ  $R: f^* \eta \Rightarrow f^* \eta|_{B \times [1]}$  which covers the standard retraction  $B \times [0, 1] \rightarrow B \times [1]$ .

Forming the composition

$$f_0^* \eta \subset f^* \eta \xRightarrow{R} f^* \eta|_{B \times [1]} = f_1^* \eta$$

we obtain an isomorphism-germ  $f_0^* \eta \Rightarrow f_1^* \eta$ . This completes the proof.

## §7. MICROBUNDLES OVER A SUSPENSION

Let  $B$  be a space with a distinguished base point  $b_0$ .

**DEFINITION.** A rooted microbundle over  $B$  will mean a microbundle  $\mathfrak{x}$  together with a specific isomorphism-germ

$$R: \mathfrak{x}|_{b_0} \Rightarrow e_{b_0}^n,$$

where  $n$  is the fibre dimension of  $\mathfrak{x}$ , and  $e_{b_0}^n$  denotes the standard trivial microbundle over  $b_0$ . Two rooted microbundles  $\mathfrak{x}'$  and  $\mathfrak{x}$  over  $B$  are isomorphic if there exists an isomorphism-germ  $\mathfrak{x}' \Rightarrow \mathfrak{x}$  which extends the given isomorphism-germ

$$R^{-1} R': \mathfrak{x}'|_{b_0} \Rightarrow \mathfrak{x}|_{b_0}.$$

It will be convenient to have a slightly sharper form of the homotopy theorem. If  $f: B \rightarrow B'$  is a map preserving base points, note that any rooted microbundle  $\eta$  over  $B'$  gives rise to a rooted microbundle  $f^* \eta$  over  $B$ .

**LEMMA (7.1).** (Rooted homotopy theorem). Let  $f_0, f_1: B \rightarrow B'$  be two maps which are homotopic under a homotopy  $f$  which leaves the base point fixed. Then  $f_0^* \eta$  is isomorphic, as rooted microbundle, to  $f_1^* \eta$ .

The proof is essentially the same as that given in §6. It is only necessary to prove (6.8) in a slightly sharper form. Note that the rooting of  $\eta$  gives rise to an isomorphism-germ

$$\bar{R}: f^* \eta|_{b_0 \times [0, 1]} \Rightarrow e_{b_0 \times [0, 1]}^n.$$

We must show that  $\bar{R}$  extends to an isomorphism-germ

$$f^* \eta|_{V \times [0, 1]} \Rightarrow e_{V \times [0, 1]}^n$$

for some neighborhood  $V$  of  $b_0$ .

According to (6.8) there exists some isomorphism-germ  $Q: f^* \eta|_{V \times [0, 1]} \Rightarrow e_{V \times [0, 1]}^n$  providing that  $V$  is small enough. Now consider the composition

$$Q\bar{R}^{-1} : e_{b_0 \times [0,1]}^n \Rightarrow e_{b_0 \times [0,1]}^n$$

Since  $b_0 \times [0, 1]$  is a retract of  $V \times [0, 1]$ , it follows easily that  $Q\bar{R}^{-1}$  extends to some isomorphism-germ  $P : e_{V \times [0,1]}^n \Rightarrow e_{V \times [0,1]}^n$ . Now  $P^{-1}Q : f^*\eta|V \times [0, 1] \Rightarrow e_{V \times [0,1]}^n$  is the required extension of  $\bar{R}$ .

The remainder of the proof of (7.1) follows that in §6. Details will be left to the reader.

Consider two rooted microbundles  $\mathfrak{x}$  and  $\eta$ , with the same fibre dimension, over base spaces  $A$  and  $B$  respectively. Let  $A \vee B$  denote the union of the two base spaces with a single point, namely the preferred base point, in common. Then a new microbundle  $\mathfrak{x} \vee \eta$  over  $A \vee B$  is obtained by pasting the fibre  $\mathfrak{x}|a_0$  onto the fibre  $\eta|b_0$ , using the given isomorphism-germs

$$\mathfrak{x}|a_0 \Rightarrow e_{a_0}^n = e_{b_0}^n \Leftarrow \eta|b_0.$$

It can be seen that  $\mathfrak{x} \vee \eta$  is well defined up to isomorphism.

Suppose in particular that  $B$  is the reduced suspension

$$SX = (X \times [0, 1]) / (X \times \{0, 1\} \cup x_0 \times [0, 1])$$

of a topological space  $X$ . There is a standard map

$$\phi : B \rightarrow B \vee B$$

which is obtained by collapsing  $X \times [\frac{1}{2}] \subset B$  to a point, and then identifying the result with  $B \vee B$ . Now given two rooted microbundles  $\mathfrak{x}$  and  $\eta$  over  $B$ , with the same fibre dimension  $n$ , one can form the induced microbundle  $\phi^*(\mathfrak{x} \vee \eta)$  over  $B$ ; also with fibre dimension  $n$ .

EXAMPLE (7.2). Let  $e^n$  denote the trivial microbundle over  $B = SX$ . Then

$$\phi^*(\mathfrak{x} \vee e^n) \cong \phi^*(e^n \vee \mathfrak{x}) \cong \mathfrak{x}.$$

Proof. Let  $c_1 : B \vee B \rightarrow B$  be the identity on the first 'summand' of  $B \vee B$  and collapse the second summand to  $b_0$ . Then  $c_1^* \mathfrak{x} \cong \mathfrak{x} \vee e^n$ . But the composition  $c_1 \phi : B \rightarrow B$  is homotopic to the identity. Therefore

$$\phi^*(\mathfrak{x} \vee e^n) \cong \phi^* c_1^* \mathfrak{x} \cong \mathfrak{x}.$$

Together with a similar argument using  $c_2$  in place of  $c_1$ , this completes the proof.

EXAMPLE (7.3). Let  $r : B \rightarrow B$  denote the 'reflection' of  $B = SX$ , corresponding to the automorphism  $(x, t) \rightarrow (x, 1 - t)$  of  $X \times [0, 1]$ . Then  $\phi^*(\mathfrak{x} \vee r^*\mathfrak{x})$  is trivial.

Proof. Let  $f : B \vee B \rightarrow B$  coincide with the identity on the first summand and with  $r$  on the second. Then  $f \phi : B \rightarrow B$  is homotopic to the constant map. Hence

$$\phi^*(\mathfrak{x} \vee r^*\mathfrak{x}) \cong \phi^* f^* \mathfrak{x} \cong e_B^n.$$

Next consider two rooted microbundles  $\mathfrak{x}$  and  $\mathfrak{x}'$  with fibre dimensions  $n$  and  $n'$  over the same base space. The Whitney sum  $\mathfrak{x} \oplus \mathfrak{x}'$  is defined to be the rooted microbundle whose distinguished isomorphism is the direct sum

$$R \oplus R' : (\mathfrak{x} \oplus \mathfrak{x}')|b_0 \Rightarrow e_{b_0}^n \oplus e_{b_0}^{n'} \cong e_{b_0}^{n+n'}.$$

LEMMA (7.4). Given rooted microbundles  $\mathfrak{x}$  and  $\mathfrak{x}'$  over  $A$  and  $\eta$  and  $\eta'$  over  $B$ , the sum  $(\mathfrak{x} \vee \eta) \oplus (\mathfrak{x}' \vee \eta')$  over  $A \vee B$  is isomorphic to  $(\mathfrak{x} \oplus \mathfrak{x}') \vee (\eta \oplus \eta')$ .

*Proof.* This is obvious.

Now a word of caution. It is not clear that the Whitney sum  $\mathfrak{x} \oplus \mathfrak{x}'$  is isomorphic (as rooted microbundle) to  $\mathfrak{x}' \oplus \mathfrak{x}$ . However this can be proved in one special case, which will suffice for our purposes. Suppose that  $B$  is a completely regular (=Tychonoff) space. Let  $n$  be the fibre dimension of  $\mathfrak{x}$ .

LEMMA (7.5). *The sum  $\mathfrak{x} \oplus \mathfrak{e}_B^n$  is isomorphic (as rooted microbundle!) to  $\mathfrak{e}_B^n \oplus \mathfrak{x}$ .*

*Proof.* It will be convenient to drop the subscript and superscript on  $\mathfrak{e}_B^n$ . Consider the preferred isomorphism-germs

$$(\mathfrak{x} \oplus \mathfrak{e})|_{b_0} \xrightarrow{R \oplus I} \mathfrak{e}_{b_0}^n \oplus \mathfrak{e}_{b_0}^n \xleftarrow{I \oplus R} (\mathfrak{e} \oplus \mathfrak{x})|_{b_0},$$

where  $I$  denotes the identity map-germ of  $\mathfrak{e}|_{b_0}$ . Composing these we obtain an isomorphism-germ

$$R \oplus R^{-1} : (\mathfrak{x} \oplus \mathfrak{e})|_{b_0} \Rightarrow (\mathfrak{e} \oplus \mathfrak{x})|_{b_0}.$$

We must show that  $R \oplus R^{-1}$  extends to an isomorphism-germ  $\mathfrak{x} \oplus \mathfrak{e} \Rightarrow \mathfrak{e} \oplus \mathfrak{x}$ .

If we ignore the rooting, then the map  $f: E(\mathfrak{x}) \times \mathbf{R}^n \rightarrow \mathbf{R}^n \times E(\mathfrak{x})$  which is defined by  $f(e, x) = (-x, e)$  gives rise to an isomorphism-germ  $F: \mathfrak{x} \oplus \mathfrak{e} \Rightarrow \mathfrak{e} \oplus \mathfrak{x}$ . We will modify  $F$  near  $b_0$ .

Choose a small closed neighborhood  $U$  of  $b_0$  and an isomorphism-germ  $Q: \mathfrak{x}|_U \Rightarrow \mathfrak{e}|_U$  which extends  $R$ . Let  $\lambda: B \rightarrow [0, \pi/2]$  satisfy

$$(\text{Support } \lambda) \subset U, \lambda(b_0) = \pi/2.$$

Now define the homeomorphism

$$g: U \times \mathbf{R}^n \times \mathbf{R}^n \rightarrow U \times \mathbf{R}^n \times \mathbf{R}^n$$

by

$$g(b, x, y) = (b, x \sin \lambda(b) - y \cos \lambda(b), x \cos \lambda(b) + y \sin \lambda(b)).$$

Thus

$$g(b, x, y) = \begin{cases} (b, x, y) & \text{if } b = b_0 \\ (b, -y, x) & \text{if } \lambda(b) = 0. \end{cases}$$

Hence the composite isomorphism-germ

$$(\mathfrak{x} \oplus \mathfrak{e})|_U \xrightarrow{Q \oplus I} (\mathfrak{e} \oplus \mathfrak{e})|_U \xrightarrow{g} (\mathfrak{e} \oplus \mathfrak{e})|_U \xrightarrow{I \oplus Q^{-1}} (\mathfrak{e} \oplus \mathfrak{x})|_U$$

coincides with  $R \oplus R^{-1}$  over  $b_0$ ; and coincides with  $F$  over the closed set  $U \cap \lambda^{-1}(0) \subset B$ . Piecing this composite together with  $F|_{\lambda^{-1}(0)}$  by means of Lemma (6.6), we obtain the required isomorphism-germ.

THEOREM (7.6). *Let  $B$  be a completely regular space which is a reduced suspension, and let  $\mathfrak{x}$  and  $\mathfrak{y}$  be rooted microbundles over  $B$  with the same fibre dimension. Then*

$$\phi^*(\mathfrak{x} \vee \mathfrak{y}) \oplus \mathfrak{e}_B^n \cong \mathfrak{x} \oplus \mathfrak{y}.$$

*Proof.* Since  $\mathfrak{y} \oplus \mathfrak{e}$  is rooted-isomorphic to  $\mathfrak{e} \oplus \mathfrak{y}$  we have

$$\phi^*((\mathfrak{x} \oplus \mathfrak{e}) \vee (\mathfrak{y} \oplus \mathfrak{e})) \cong \phi^*((\mathfrak{x} \oplus \mathfrak{e}) \vee (\mathfrak{e} \oplus \mathfrak{y})).$$

But the left side is isomorphic to

$$\phi^*((x \vee \eta) \oplus (e \vee e)) \cong \phi^*(x \vee \eta) \oplus e;$$

while the right side is isomorphic to

$$\phi^*((x \vee e) \oplus (e \vee \eta)) \cong x \oplus \eta.$$

This completes the proof.

As a special case, since  $\phi^*(x \vee r^*x)$  is trivial, this gives:

**COROLLARY (7.7).** *The sum  $x \oplus r^*x$  is trivial.*

Clearly this proves the Lemma (4.2) which was assumed earlier.

Another useful consequence is the following. Let  $f_d: S^k \rightarrow S^k$  be a mapping from the sphere to itself of degree  $d$ .

**COROLLARY (7.8).** *The induced homomorphism*

$$f_d^*: \mathbf{k}_{\text{Top}}(S^k) \rightarrow \mathbf{k}_{\text{Top}}(S^k)$$

*is just multiplication by  $d$ .*

*Proof.* For  $d = 0$  or  $d = 1$  this assertion is clear. The proof for other values of  $d$  will be by ascending or descending induction on  $d$ .

Let  $g: S^k \vee S^k \rightarrow S^k$  be the identity map on the first summand, and have degree  $d$  on the second summand. Then the composition  $g\phi: S^k \rightarrow S^k$  has degree  $d+1$ . Hence for any  $x$  over  $S^k$ :

$$f_{d+1}^*x \cong \phi^*g^*x \cong \phi^*(x \vee f_d^*x).$$

Adding a trivial microbundle to both sides, this gives

$$(f_{d+1}^*x) \oplus e \cong x \oplus f_d^*x.$$

After a straightforward induction argument, this completes the proof.

## §8. THE HOMOMORPHISM $\mathbf{k}_0(S^{4n}) \rightarrow \mathbf{k}_{\text{Top}}(S^{4n})$

According to Bott ([4], [5]) the group  $\mathbf{k}_0(S^{4n})$  is infinite cyclic. Let  $(\gamma)$  denote a generator. Let  $B_n$  denote the  $n$ th Bernoulli number and let  $\text{num}(B_n/n)$  denote the numerator of the rational number  $B_n/n$  when expressed as a fraction in lowest terms. The object of this section will be to prove the following:

**THEOREM (8.1).** *The image in  $\mathbf{k}_{\text{Top}}(S^{4n})$  of the generator  $(\gamma)$  is divisible by the integer  $(2^{2n-1} - 1)\text{num}(B_n/n)$ .*

For  $n = 1, 2, 3, 4$  this integer is respectively 1, 7, 31, 127. (*Remark.* The factor  $\text{num}(B_n/n)$  equals 1 for  $n = 1, 2, 3, 4, 5, 7$  only. It grows more than exponentially for larger values of  $n$ .)

It follows that this homomorphism  $\mathbf{k}_0(S^{4n}) \rightarrow \mathbf{k}_{\text{Top}}(S^{4n})$  is not an isomorphism for  $n > 1$ . It is difficult to say anything much more precise about this homomorphism; since it is not even known whether the groups  $\mathbf{k}_{\text{Top}}(S^r)$  are finite, countably infinite, or uncountably infinite.

In order to prove (8.1) we must have a procedure for constructing exotic microbundles over  $S^{4n}$ . This will be done as follows. We may assume that  $n > 1$ , since there is nothing to prove in the case  $n = 1$ .

According to Kervaire and Milnor [13, Part II] there exists a manifold-with-boundary  $W$  of dimension  $4n$ ,  $n > 1$ , with the following description.  $W$  is smooth, parallelizable, and has the homotopy type of the 8-fold bouquet  $S^{2n} \vee S^{2n} \vee \dots \vee S^{2n}$ . The boundary  $\partial W$  is topologically a  $(4n - 1)$ -sphere. In fact, choosing a  $C^1$ -triangulation [24],  $\partial W$  is even a piecewise-linear sphere. Finally the intersection-number pairing

$$H_{2n}W \otimes H_{2n}W \rightarrow \mathbb{Z}$$

is positive definite; so that the signature of  $W$  is  $+8$ .

Let  $M = W \cup C(\partial W)$  be the topological manifold which is obtained by adjoining a cone over the boundary of  $W$ . (Actually  $M$  can be given the structure of a piecewise-linear manifold.) Let  $f: M \rightarrow S^{4n}$  have degree 1.

**LEMMA (8.2).** *There exists a microbundle  $x$  over  $S^{4n}$  so that  $f^*x$  is isomorphic to the tangent microbundle  $t_M$ .*

*Proof.* Since a neighborhood of  $W$  in  $M$  can be given the structure of a parallelizable smooth manifold, it follows from §2.2 that  $t_M|_W$  is trivial. Therefore, according to §3.3, it follows that  $t_M$  can be extended to a microbundle over  $M \cup C(W)$ . Since  $M \cup C(W)$  has the homotopy type of  $S^{4n}$ ; this completes the proof.

Thus we have constructed an unusual microbundle  $x$  over  $S^{4n}$ . We will prove that the corresponding  $s$ -class  $(x) \in k_{\text{Top}}S^{4n}$  is related to the generator  $(\gamma)$  of  $k_0S^{4n}$  as follows. Let  $j_n$  denote the order of the image

$$J\pi_{4n-1}(\text{SO}_l) \subset \pi_{4n-1+l}(S^l)$$

of the stable  $J$ -homomorphism ( $l > 4n$ ); and let  $a_n$  equal 1 or 2 according as  $n$  is even or odd. It will be convenient to introduce the abbreviation

$$b_n = 2^{2n-4}(2^{2n-1} - 1)B_n j_n a_n / n.$$

This number  $b_n$  is an integer. (Compare [17].) We may assume that orientations are chosen so that  $p_n(\gamma)[S^{4n}] > 0$ .

**THEOREM (8.3).** *The sum  $x \oplus \dots \oplus x$  of  $b_n$  copies of  $x$  is  $s$ -isomorphic to the sum  $|\gamma \oplus \dots \oplus \gamma|$  of  $j_n$  copies of  $|\gamma|$ .*

In other words, the identity  $b_n(x) = j_n(|\gamma|)$  is valid in  $k_{\text{Top}}S^{4n}$ .

*Remark (1).* In the terminology of Kervaire and Milnor [13, §7.6], the integer  $b_n$  is equal to the order of the cyclic group  $bP_{4n} \subset \Theta_{4n-1}$ , consisting of  $h$ -cobordism classes of homotopy spheres which bound parallelizable manifolds.

*Remark (2).* The reader who wishes to skip the number theory need only think of one special case; namely:  $n = 2$ ,  $j_2 = 240$ ,  $a_2 = 1$ ,  $B_2 = 1/30$ ,  $b_2 = 28$ . This case will suffice for all practical purposes.

The proof of (8.3) will occupy the rest of §8. Let  $M'$  denote the connected sum  $M \# \dots \# M$  of  $b_n$  copies of  $M$ . Here  $M$  is to be thought of as a piecewise-linear manifold; so that this sum will be well defined up to piecewise-linear isomorphism (Compare [14, p. 1].)

LEMMA (8.4). *This  $b_n$ -fold sum  $M'$  admits a smoothness structure.*

*Proof.* Clearly  $M'$  admits a smoothness structure except on the  $b_n$  points which correspond to the vertex of the cone  $C(\partial W^{4n})$ . Choose a piecewise-linear imbedding of a  $4n$ -simplex in  $M'$  so that all  $b_n$  exceptional points lie in the interior  $U$  of this simplex. Thus  $M' - U$  admits a parallelizable smoothness structure. It follows from Hirsch [10, Theorem (7.5)] that we can modify this structure so that  $\partial(M' - U)$  is a smooth submanifold. The signature of  $(M' - U)$  is precisely  $8b_n$ . But according to [13, §7.5] together with Smale [20, Theorem 1.1] this implies that  $\partial(M' - U)$  is diffeomorphic to the standard  $(4n - 1)$ -sphere; hence the given smoothness structure can be extended throughout  $U$ .

We must find the relationship between the tangent microbundle  $t'$  of the sum  $M'$  and the tangent microbundle  $t$  of  $M$ . The following Lemma is valid for any compact piecewise-linear manifold  $M$ .

LEMMA (8.5). *If  $M'$  is the connected sum of  $b$  copies of  $M$ , then there exists a map  $g: M' \rightarrow M$  of degree  $b$  so that  $g^*t$  is  $s$ -isomorphic to  $t'$ .*

*Proof.* Let  $D^n$  denote a piecewise-linear  $4n$ -cell. Choose a piecewise-linear imbedding  $F$  of the 'handle'  $[0, 1] \times D^{4n}$  in  $M \times [0, \infty)$  so that  $[0] \times D^{4n}$  and  $[1] \times D^{4n}$  go into  $M \times [0]$ . (Compare Fig. 4.) Then the  $b$ -fold sum  $M'$  can be obtained from  $b$  disjoint copies of  $M$  as follows. For each  $i = 1, \dots, k - 1$ , remove the disk  $F([0] \times D^{4n})$  from the  $i$ th copy of  $M$ ; remove  $F([1] \times D^{4n})$  from the  $(i + 1)$ st copy; and join the resulting boundaries by a copy of the tube  $F([0, 1] \times \partial D^{4n})$ .

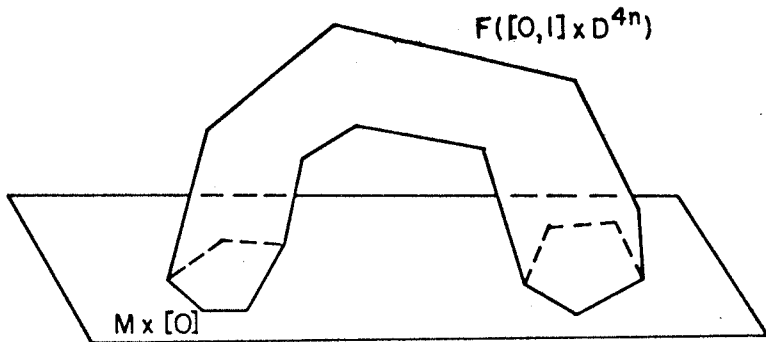

FIG. 4.

If one forms  $M'$  in this way then there is clearly a canonical map  $M' \rightarrow M \times [0, \infty)$  which carries each copy of  $M$  (with one or two disks removed) into  $M \times [0]$ , and carries each copy of  $F([0, 1] \times \partial D^{4n})$  into  $F([0, 1] \times \partial D^{4n})$ . Now 'thickening' slightly, we obtain a piecewise-linear immersion of  $M' \times (-\epsilon, \epsilon)$  into  $M \times \mathbb{R}$ . This induces a bundle map-germ

$$t' \times e_{(-\epsilon, \epsilon)}^1 \Rightarrow t \times e_{\mathbb{R}}^1.$$

Restricting the first microbundle to  $M' \times [0]$ , and projecting the second to  $M$ ; this yields a bundle map-germ

$$t' \oplus \epsilon_{M'}^1 \Rightarrow t \oplus \epsilon_M^1,$$

covering a map  $M' \rightarrow M$  which clearly has degree  $b$ . This completes the proof of (8.5).

Now let  $f': M' \rightarrow S^{4n}$  have degree 1, and let  $g_0: S^{4n} \rightarrow S^{4n}$  have degree  $b_n$ . Thus we obtain a homotopy commutative diagram

$$\begin{array}{ccc} M' & \xrightarrow{g} & M \\ \downarrow f' & & \downarrow f \\ S^{4n} & \xrightarrow{g_0} & S^{4n} \end{array}$$

The microbundle  $\alpha$  over  $S^{4n}$  lifts under  $f'^*$  to  $t$ , and then under  $g^*$  to a microbundle  $s$ -isomorphic to  $t'$ . Hence  $(g_0^*\alpha)$  lifts under  $f'^*$  to  $(t')$ .

But  $M'$  admits a smoothness structure; hence  $t'$  is isomorphic to  $|\tau'|$ , where  $\tau'$  is the tangent vector bundle. Furthermore  $\tau'|_{(M'\text{-point})}$  is trivial; so that an argument similar to the proof of (8.2) shows that

$$\tau' \cong f'^*\xi$$

for some vector bundle  $\xi$  over  $S^{4n}$ .

Thus we have two different elements  $(|\xi|)$  and  $(g_0^*\alpha)$  in  $\mathbf{k}_{\text{Top}}(S^{4n})$  which both have the same image  $(t')$  under  $f'^*$ . We will prove:

LEMMA (8.6). *The homomorphism  $f'^*: \mathbf{k}_{\text{Top}}(S^{4n}) \rightarrow \mathbf{k}_{\text{Top}}M'$  has kernel zero.*

This will imply that  $(|\xi|) = g_0^*(\alpha)$ .

Assuming (8.6) for the moment, the proof of (8.3) follows.

According to §7.8 the induced bundle  $g^*\alpha$  is  $s$ -isomorphic to the sum  $\alpha \oplus \dots \oplus \alpha$  of  $b_n$  copies of  $\alpha$ . We will show that  $\xi$  is  $s$ -isomorphic to the sum of  $j_n$ -copies of  $\gamma$ . This will prove (8.3).

Since  $\mathbf{k}_0(S^{4n})$  is infinite cyclic, in order to prove that  $(\xi) = j_n(\gamma)$  it is sufficient to check that the Pontrjagin class  $p_n(\xi)$  is equal to  $j_n$  times  $p_n(\gamma)$ .

For the generator  $\gamma$ , Bott has shown that  $p_n(\gamma)$  is equal to  $a_n(2n-1)!$  times a generator of  $H^{4n}(S^{4n})$ . (Compare [6].)

To compute  $p_n(\xi)$  it is clearly sufficient to compute the Pontrjagin number  $p_n[M']$ . According to the Hirzebruch signature Theorem [11, §8] we have

$$\sigma(M') = 2^{2n}(2^{2n-1} - 1)B_n p_n[M'] / (2n)!$$

(The terms in  $p_1, \dots, p_{n-1}$  vanish since  $M'$ -point is parallelizable.) But the signature  $\sigma(M')$  is equal to  $8b_n$ . Substituting in the definition:  $b_n = 2^{2n-4}(2^{2n-1} - 1)B_n j_n a_n / n$ , this yields

$$p_n[M'] = j_n a_n (2n-1)!$$

Thus  $p_n(\xi)$  is equal to  $j_n$  times  $p_n(\gamma)$ . This proves (8.3) (except for the proof of (8.6)).

*Proof of (8.6).* We must study  $f'^*: k_{\text{Top}} S^{4n} \rightarrow k_{\text{Top}} M'$ . Following Wall [22] note that  $M'$  has the homotopy type of some complex of the form  $(S^{2n} \vee \dots \vee S^{2n}) \cup e^{4n}$ , formed from a bouquet of  $8b_n$  copies of  $S^{2n}$  by attaching a  $4n$ -cell, using an attaching map

$$h: S^{4n-1} \rightarrow S^{2n} \vee \dots \vee S^{2n}.$$

According to §4.4 there is a half-infinite exact sequence

$$\dots \rightarrow k_{\text{Top}}(S^{2n+1} \vee \dots \vee S^{2n+1}) \xrightarrow{Sh^*} k_{\text{Top}} S^{4n} \xrightarrow{f'^*} k_{\text{Top}} M' \rightarrow \dots$$

Thus in order to prove that  $f'^*$  has kernel zero, it is sufficient to prove that the suspension  $Sh$  is homotopic to a constant. (In the terminology of Puppe [18, Part II] this means that  $M'$  is 'sphere-like'.)

To prove that  $Sh$  is null-homotopic, note that the homotopy class of  $h$  belongs to

$$\pi_{4n-1}(S^{2n} \vee \dots \vee S^{2n}) \cong \pi_{4n-1}(S^{2n}) \oplus \dots \oplus \pi_{4n-1}(S^{2n}) \oplus \mathbf{Z} \oplus \dots \oplus \mathbf{Z}.$$

(There are  $8b_n$  copies of  $\pi_{4n-1}(S^{2n})$  corresponding to the  $8b_n$  summands  $S^{2n}$ ; and  $8b_n(8b_n - 1)/2$  copies of  $\mathbf{Z}$ , arising from Whitehead product terms.) The suspension homomorphism carries all of the Whitehead product terms to zero; so that

$$\pi_{4n}(S^{2n+1} \vee \dots \vee S^{2n+1}) \cong \pi_{4n}(S^{2n+1}) \oplus \dots \oplus \pi_{4n}(S^{2n+1}).$$

Thus to prove that  $Sh \sim 0$  it is sufficient to check that each of the  $8b_n$  elements of  $\pi_{4n-1}(S^{2n})$  determined by  $h$  suspends into zero.

According to Wall [22], each such element in  $\pi_{4n-1}(S^{2n})$  can be expressed in the form  $J\alpha$ , where  $\alpha \in \pi_{2n-1}(S_{0,2n})$  is the homotopy class which describes the normal bundle of a suitably imbedded  $2n$ -sphere in  $M'$ , and where  $J$  is the Hopf-Whitehead homomorphism. But  $(M', \text{point})$  is parallelizable, hence each such  $\alpha$  maps into zero in the stable group  $\pi_{2n-1}(S_0)$ . Now, from the anti-commutative diagram

$$\begin{array}{ccc} \pi_{2n-1}(S_{0,2n}) & \longrightarrow & \pi_{2n-1}(S_{0,2n+1}) \cong \pi_{2n-1}(S_0) \\ \downarrow J & & \downarrow J \\ \pi_{4n-1}(S^{2n}) & \xrightarrow{S} & \pi_{4n}(S^{2n+1}) \end{array}$$

we see that  $SJz = 0$ . (Compare [23], [25].) This completes the proof of (8.6) and (8.3).

*Proof of Theorem (8.1).* We are given the identity

$$(1) \quad b_n(x) = j_n(|\gamma|),$$

and must prove that  $(|\gamma|)$  is divisible by  $(2^{2n-1} - 1)\text{num}(B_n/n)$ . We will need the following:

**THEOREM OF ADAMS [2].** *The integer  $j_n$  is equal to either 4 or 8 times the denominator of  $B_n/n$ .*

By definition,  $b_n = 2^{2n-4}(2^{2n-1} - 1)B_n j_n a_n/n$ . Hence by Adams' theorem,  $b_n$  is equal to  $2^x(2^{2n-1} - 1)\text{num}(B_n/n)$ , for some integer  $x$ .



LEMMA (8.7). *The integer  $j_n$  is relatively prime to  $(2^{2n-1} - 1)\text{num}(B_n/n)$ .*

*Proof.* Since  $j_n = 2^l \text{denom}(B_n/n)$  it is clear that  $\text{num}(B_n/n)$  (which is always odd) is prime to  $j_n$ . But for any odd prime  $p$ , if  $p$  divides  $j_n$  then it follows from von Staudt's theorems that  $2n \equiv 0 \pmod{p-1}$ . (See [17, p. 457].) Hence  $2^{2n} \equiv 1 \pmod{p}$ , so that  $2(2^{2n-1} - 1) \equiv -1 \pmod{p}$ . This shows that  $p$  does not divide  $2^{2n-1} - 1$ ; and proves (8.7).

Thus we can find integers  $r$  and  $s$  so that

$$(2) \quad rj_n + s(2^{2n-1} - 1)\text{num}(B_n/n) = 1.$$

Now (1) implies that

$$(|\gamma|) = (1 - rj_n)(|\gamma|) + rb_n(x).$$

But (2) implies that the coefficient  $1 - rj_n$  is divisible by  $(2^{2n-1} - 1)\text{num}(B_n/n)$ . Similarly the equality  $b_n = 2^x(2^{2n-1} - 1)\text{num}(B_n/n)$  shows that the coefficient  $rb_n$  is divisible by  $(2^{2n-1} - 1)\text{num}(B_n/n)$ . Therefore the  $s$ -class  $(|\gamma|)$  is divisible by  $(2^{2n-1} - 1)\text{num}(B_n/n)$ . This completes the proof.

### §9. APPLICATIONS: PONTRJAGIN CLASSES ARE NOT TOPOLOGICAL INVARIANTS

Let  $n > 1$  be an integer and let  $q$  be a prime dividing  $(2^{2n-1} - 1)\text{num}(B_n/n)$ . (For example  $n = 2, q = 7$ .) Let  $X = S^{4n-1} \cup_q e^{4n}$  denote the complex formed from the  $(4n-1)$ -sphere by attaching a  $4n$ -cell, using an attaching map of degree  $q$ .

LEMMA (9.1). *The canonical homomorphism  $k_{\mathbf{O}}X \rightarrow k_{\text{Top}}X$  is zero; although the group  $k_{\mathbf{O}}X$  is cyclic of order  $q$ .*

*Proof.* By §4.4 there is an exact sequence

$$k_{\text{Top}}S^{4n} \xrightarrow{Sf^*} k_{\text{Top}}S^{4n} \xrightarrow{c^*} k_{\text{Top}}X \longrightarrow k_{\text{Top}}S^{4n-1} \xrightarrow{f^*} k_{\text{Top}}S^{4n-1}$$

where  $f: S^{4n-1} \rightarrow S^{4n-1}$  denotes a map of degree  $q$ . According to §7.8 the homomorphisms  $f^*$  and  $Sf^*$  are just multiplication by  $q$ . There is a similar exact sequence for  $k_{\mathbf{O}}$ ; and again  $Sf^*$  is multiplication by  $q$ .

In the case of the functor  $k_{\mathbf{O}}$  it is known that the group  $k_{\mathbf{O}}S^{4n} \cong \pi_{4n-1}\mathbf{O}$  is infinite cyclic; and that  $k_{\mathbf{O}}S^{4n-1} \cong \pi_{4n-2}\mathbf{O}$  is zero (Bott [4].) Therefore the exact sequence reduces to

$$\mathbf{Z} \longrightarrow \mathbf{Z} \xrightarrow{c^*} \mathbf{Z}_q \longrightarrow 0 \longrightarrow 0.$$

Now consider the diagram

$$\begin{array}{ccc} k_{\mathbf{O}}S^{4n} & \xrightarrow{c^*} & k_{\mathbf{O}}X \\ \downarrow u' & & \downarrow u \\ k_{\text{Top}}S^{4n} & \xrightarrow{c^*} & k_{\text{Top}}X. \end{array}$$

According to §8.1, if  $(\gamma)$  generates  $k_{\mathbf{O}}S^{4n}$  then its image  $u'(\gamma)$  in  $k_{\text{Top}}S^{4n}$  is divisible by  $q$ . Therefore  $c^*u'(\gamma) = uc^*(\gamma)$  is zero. But  $c^*(\gamma)$  generates the finite cyclic group  $k_{\mathbf{O}}X$ . This completes the proof of (9.1).

Now choose an imbedding of  $X$  in some Euclidean space  $\mathbf{R}^m$  of sufficiently high dimension; and let  $U$  be any neighborhood having  $X$  as retract. Clearly, if  $U$  is given its usual smoothness structure, it will be a parallelizable manifold.

**THEOREM (9.2).** *The open set  $U \times \mathbf{R}^k \subset \mathbf{R}^{m+k}$  can be given a new smoothness structure so that it is no longer a parallelizable manifold; providing that  $k$  is large enough.*

*Proof.* (Compare [15], where a somewhat easier argument is used.) It follows from (9.1) that the homomorphism  $\mathbf{k}_0 U \rightarrow \mathbf{k}_{\text{Top}} U$  has a non-zero element  $c^*(\gamma)$  in its kernel. Hence according to Theorem (5.13),  $U \times \mathbf{R}^k$  can be smoothed so that its tangent bundle  $\tau$  satisfies  $(\tau|U \times 0) = c^*(\gamma) \neq 0$ . This completes the proof.

If the prime  $q$  is greater than  $2n$  (for example  $q = 7, n = 2$ ) then this theorem can be sharpened as follows.

**COROLLARY (9.3).** *If  $q > 2n$  then the exotic differentiable structure on  $U \times \mathbf{R}^k$  is such that the Pontrjagin class  $p_n(\tau)$  is a non-zero torsion element.*

*Proof.* According to Bott [6] the class  $p_n(\gamma)$  is  $a_n(2n - 1)!$  times a generator of  $H^{4n} S^{4n}$ . Therefore  $p_n c^*(\gamma) = c^* p_n(\gamma)$  is  $a_n(2n - 1)!$  times a generator of the cyclic group  $H^{4n} X \cong \mathbf{Z}_q$ . If  $q > 2n$  then  $q$  is relatively prime to  $a_n(2n - 1)!$  so that  $p_n c^*(\gamma) \neq 0$ . This completes the proof.

Thus the Pontrjagin classes of an open manifold are not topological invariants. I hope to sharpen this statement in a latter paper by putting two different smoothness structures on a certain closed, triangulated 9-manifold, both being compatible with the triangulation, so that  $p_2(\tau)$  is zero in one case, and a non-zero element of order 7 in the second case. [In contrast Thom [21] and Rohlin and Švarč [19] have shown that the *rational* Pontrjagin classes of a triangulated manifold are combinatorial invariants. The *topological* invariance of rational Pontrjagin classes remains unknown.]

Another application of (8.1) can be given as follows:

**LEMMA (9.4).** *There exists a finite complex  $X'$  so that the homomorphism  $\mathbf{k}_0 X' \rightarrow \mathbf{k}_{\text{Top}} X'$  is not onto.*

The proof will give two possibilities for  $X'$ .

*Case (1).* If the group  $\mathbf{k}_{\text{Top}} S^8$  is infinite, then the sphere  $S^8$  itself can be taken as the complex  $X'$ . For suppose on the contrary that the homomorphism  $\mathbf{k}_0 S^8 \rightarrow \mathbf{k}_{\text{Top}} S^8$  were onto. It would follow that  $\mathbf{k}_{\text{Top}} S^8$  was infinite cyclic, generated by  $(|\gamma|)$ . But this would contradict the theorem that  $(|\gamma|)$  is divisible by 7.

*Case (2).* Suppose that  $\mathbf{k}_{\text{Top}} S^8$  is finite. Then the prime 5 certainly divides the order of  $\mathbf{k}_{\text{Top}} S^8$ . For, using the methods of Thom and Wu [27], it is possible to define a characteristic class

$$c(x) \in H^8(B(x); \mathbf{Z}_5)$$

for microbundles; which generalizes the characteristic class  $p_1^2 - 2p_2$ , reduced modulo 5. Thus one can define a homomorphism from  $\mathbf{k}_{\text{Top}} S^8$  onto  $\mathbf{Z}_5$ . This implies that the finite group  $\mathbf{k}_{\text{Top}} S^8$  must contain a non-trivial element of order 5.

Let  $X' = S^8 \cup_5 e^9$  be obtained by attaching a 9-cell to an 8-sphere by a map of degree 5.

From the exact sequence

$$k_{\text{Top}} X' \longrightarrow k_{\text{Top}} S^8 \xrightarrow{5} k_{\text{Top}} S^8$$

one sees that  $k_{\text{Top}} X' \neq 0$ . On the other hand it is not difficult to show that  $k_0 X' = 0$ ; so that the canonical homomorphism is not onto. This completes the proof.

A geometrical application of (9.4) can be given as follows:

**THEOREM (9.5).** *There exists a topological manifold  $M$  so that no cartesian product  $M \times M'$  can be smoothed.*

*Proof.* (Compare [15].) Imbed  $X'$  as a retract of an open set  $U$  in some Euclidean space  $\mathbb{R}^m$ . Then there exists a microbundle  $\mathfrak{x}$ , with diagram

$$U \xrightarrow{i} E \xrightarrow{j} U,$$

whose  $s$ -class ( $\mathfrak{x}$ ) does not lie in the image of the homomorphism  $k_0 U \rightarrow k_{\text{Top}} U$ . Let  $M$  be a neighborhood of  $i(U)$  in  $E$  which is small enough so as to be a manifold.

According to §5.9, the tangent microbundle  $t_M |i(U)$  is isomorphic to  $t_U \oplus \mathfrak{x} \cong e_U^m \oplus \mathfrak{x}$ . Since this is not isomorphic to  $|\zeta|$  for any vector bundle  $\zeta$ , it follows from §2.2 that  $M$  cannot be smoothed.

For an arbitrary manifold  $M'$  with base point  $b$  we have

$$t_{M \times M'} |i(U) \times b \cong t_U \oplus \mathfrak{x} \oplus e_U^{m'}.$$

Therefore the same argument shows that  $M \times M'$  cannot be smoothed.

#### REFERENCES

1. J. F. ADAMS: Vector fields on spheres, *Ann. Math., Princeton* **75** (1962), 603–632.
2. J. F. ADAMS: On the groups  $J(X)$ —Part I, *Topology* **2** (1963), 181–195; Part II to be published.
3. M. F. ATIYAH and F. HIRZEBRUCH: Riemann–Roch theorems for differentiable manifolds, *Bull. Amer. Math. Soc.* **65** (1959), 276–281.
4. R. BOTT: The stable homotopy of the classical groups, *Ann. Math., Princeton* **70** (1959), 313–337.
5. R. BOTT: *Lectures on  $K(X)$*  (mimeographed notes), Harvard University, 1962.
6. R. BOTT and J. MILNOR: On the parallelizability of the spheres, *Bull. Amer. Math. Soc.* **64** (1958), 87–89.
7. M. BROWN: Locally flat imbeddings of topological manifolds, *Ann. Math., Princeton* **75** (1962), 331–341.
8. M. CURTIS and R. LASHOF: On product and bundle neighborhoods, *Proc. Amer. Math. Soc.* **13** (1962), 934–937.
9. O. HANNER: Some theorems on absolute neighborhood retracts, *Arkiv. Mat.* **1** (1950), 389–408.
10. M. HIRSCH: On combinatorial submanifolds of differentiable manifolds, *Comment. Math. Helvet.* **36** (1962), 103–111.
11. F. HIRZEBRUCH: *Neue topologische Methoden in der algebraischen Geometrie*, Springer, Berlin, 1956.
12. W. HUREWICZ and H. WALLMAN: *Dimension theory*, Princeton University Press, 1948.
13. M. KERVAIRE and J. MILNOR: Groups of homotopy spheres—Part I, *Ann. Math., Princeton* **77** (1963), 504–537.; Part II in preparation.
14. J. MILNOR: A unique decomposition theorem for 3-manifolds, *Amer. J. Math.* **84** (1962), 1–7.
15. J. MILNOR: Topological manifolds and smooth manifolds, *Proceedings of the International Congress of Mathematicians, Stockholm* (1962), 132–138.
16. J. MILNOR: *Morse theory*, Princeton University Press, 1963.
17. J. MILNOR and M. KERVAIRE: Bernoulli numbers, homotopy groups and a theorem of Rohlin, *Proceedings of the International Congress of Mathematicians, Edinburgh*, pp. 454–458. Cambridge University Press, 1960.
18. D. PUPPE: Homotopiemengen und ihre induzierten Abbildungen, *Math. Z.* **69** (1958), 299–344; 395–417.

19. V. A. ROHLIN and A. S. ŠVARČ: Combinatorial invariance of the Pontrjagin classes (Russian), *Dokl. Akad. Nauk. SSSR* **114** (1957), 490–493.
20. S. SMALE: On the structure of manifolds, *Amer. J. Math.* **84** (1962), 387–399.
21. R. THOM: Les classes caractéristiques de Pontrjagin des variétés triangulées, *Symposium International de Topologia Algebraica* (Mexico, 1958), pp. 54–67.
22. C. T. C. WALL: Classification of  $(n-1)$ -connected  $2n$ -manifolds, *Ann. Math., Princeton* **75** (1962), 163–189.
23. G. W. WHITEHEAD: On the homotopy groups of spheres and rotation groups, *Ann. Math., Princeton* **43** (1942), 634–640.
24. J. H. C. WHITEHEAD: On  $C^1$ -complexes, *Ann. Math., Princeton* **41** (1940), 809–824.
25. J. H. C. WHITEHEAD: On certain theorems of G. W. Whitehead, *Ann. Math., Princeton* **58** (1953), 418–428.
26. J. H. C. WHITEHEAD: Manifolds with transverse fields in Euclidean space, *Ann. Math., Princeton* **73** (1961), 154–212.
27. WU WEN-TSÜN: On Pontrjagin classes—II, *Scientia Sinica*, **4** (1955), 455–490.

*Princeton University,*  
*Princeton, New Jersey, U.S.A.*