

3 1761 04001 1694





Digitized for Microsoft Corporation  
by the Internet Archive in 2007.

From University of Toronto.

May be used for non-commercial, personal, research,  
or educational purposes, or any fair use.

May not be indexed in a commercial service.



SCIENTIFIC PAPERS.

London: C. J. CLAY AND SONS,  
CAMBRIDGE UNIVERSITY PRESS WAREHOUSE,  
AVE MARIA LANE.  
Glasgow: 263, ARGYLE STREET.



Leipzig: F. A. BROCKHAUS.  
New York: THE MACMILLAN COMPANY.  
Bombay: E. SEYMOUR HALE.

# SCIENTIFIC PAPERS

BY

PETER GUTHRIE TAIT, M.A. SEC. R.S.E.

HONORARY FELLOW OF PETERHOUSE, CAMBRIDGE,  
PROFESSOR OF NATURAL PHILOSOPHY IN THE UNIVERSITY OF EDINBURGH.

VOL. I.

45063  
26/4/99

CAMBRIDGE:  
AT THE UNIVERSITY PRESS.

1898

[All Rights reserved.]

Cambridge:

PRINTED BY J. AND C. F. CLAY,  
AT THE UNIVERSITY PRESS.

QC  
3  
T25  
v.1

## PREFACE.

WHEN the Syndics of the University Press did me the unexpected honour of proposing to reprint such of my scientific papers as I should select, they advised me to lean, in doubtful cases, rather to the side of comprehension than to that of exclusion. The selection has given me considerable anxiety, for (even after the numerous polemical items had, of course, been set aside) the doubtful cases formed a large majority.

Since I took my degree the greater part of my time has been spent in teaching and its necessary concomitants. The rest, except in so far as it was devoted to the preparation of text-books, has been occupied rather with fresh mathematical or experimental inquiries than in fully "writing out" the results of earlier ones. Thus the present collection presents a very irregular aspect:—a few only of the papers giving anything like full details, while the remainder are often of the most fragmentary character, being in many cases no more than very condensed abstracts.

Among the more detailed papers are the earlier of those in which quaternions are employed. These were written while I was endeavouring to familiarise myself with the new calculus, and were, in great part, worked out before I had any communication with Sir W. R. Hamilton except through his *Lectures* (1853); a fascinating book, which, by great good fortune, I had taken with me on a vacation tour as a companion for wet days. When I made Hamilton's acquaintance a year or two later, through Dr Andrews, I submitted to him some of the more formidable difficulties which I had met in the study of his great work, and the hints I thus obtained were of much use to me in finally preparing these papers for publication. As they received a cordial *imprimatur* from Hamilton, with a notice\* recommending them to the attention of students of the subject, I had no hesitation in deciding to reprint them in the present collection.

\* *Elements of Quaternions*, 1866; p. 755 (foot-note).

But I feel that this explanation of their second appearance is called for, as their contents are mainly, as it were, a translation of other men's investigations into a vastly superior (though at the time they were written an all-but-unknown) language, not an incursion into unexplored regions of physics. And, when I wrote them, my practical acquaintance with the extraordinary resources and flexibility of the new language was still very limited.

I have not reprinted any papers which are not exclusively my own. Those in which I was associated with Dr Andrews have already been reprinted in his *Life* (Macmillan, 1889). But the titles of all such joint productions, along with slight indications of the nature of their contents, will be given in a supplementary list, containing references to nearly all but the most ephemeral of my scientific articles.

Several of the papers in the present collection have already been in part reprinted in text-books, such as my *Quaternions*, *Properties of Matter*, &c. On the other hand, some of these books (especially *Dynamics of a Particle*, which I wrote in conjunction with the late Mr W. J. Steele) contain a considerable amount of original work which was not laid before any scientific Society. No part of that has been reproduced in this collection, mainly because the books containing it have already passed through several editions. I was much inclined, however, to make some extracts from the last named work, such as for instance my proof (the first, I believe, which was given) of Hamilton's *Theorem of Hodographic Isochronism*, and some similar investigations. These would have taken the first place in the present volume, for the order of the various articles has been determined, as a rule, by their dates. The sole exception is in the cases where there is a series of articles on one subject, such as that which deals with *Knots*. The earliest (reprinted) paper of such a series is inserted at its proper place, and the others (each provided with its special date) follow immediately in their own relative order.

In preparing the collection for press I have simply rectified obvious slips or exaggerations, and printers' errors. Of these by far the most serious have evidently been caused by careless replacement of types which had fallen out during printing. On the other hand, all *material* alterations, however slight, have been indicated by the use of square brackets, [*containing the date of the change*]. Under the head of obvious slips I include some of the choice expressions current in Cambridge in my undergraduate days:—such as “*velocity*” for “*speed*,” the “*equation to a curve*,” the “*center of a circle*,” and the doubly-dyed “*center of gravity*.” The  $\_$  notation for factorials,

much in vogue in those days, has been replaced by the ! ; and the very useful "solidus" has been called in where required.

Several of the more condensed *Abstracts* have been reprinted although they contain, as bare statements without detail of processes, results which have not yet been tested by subsequent verification:—one or two even contain speculations which have been shown by myself to be inaccurate as they at present stand. But these take up little space; and No. XIV, for instance, which is one of the latter and less defensible class, shows *how* I was led to make the protracted experimental inquiries which are described in detail in Nos. XXVIII, XXIX, and XLVIII. It has, on this account, still a very special interest for myself:—and there seems to be no doubt that it contains at least the germs of an important truth, which I have not as yet succeeded in putting in an unexceptionable form.

My special thanks are due to the Council of the Royal Society of Edinburgh, and to Sir John Murray of the *Challenger* Expedition, not alone for permission to reprint the papers which form the bulk of the present collection but for the loan of the large number of wood-blocks employed in their illustration.

Also to Drs C. G. Knott and W. Peddie, former and present Official Assistants to the Professor of Natural Philosophy in Edinburgh University, both adepts in Quaternions as well as in Physics, for the assistance which they have given me in the reading of the proof-sheets.

P. G. TAIT.

COLLEGE, EDINBURGH,  
*July 1st, 1898.*





## CONTENTS.

	PAGE
I. <i>Quaternion investigations connected with Fresnel's wave-surface</i> Quarterly Mathematical Journal, 1859.	1
II. <i>Note on the Cartesian equation of the wave-surface</i> . . . . . Quarterly Journal of Pure and Applied Mathematics, 1859.	20
III. <i>Quaternion investigations connected with electro-dynamics and magnetism</i> . . . . . Quarterly Journal of Mathematics, 1860.	22
IV. <i>Quaternion investigation of the potential of a closed circuit</i> . . . . . Quarterly Journal of Mathematics, 1860.	33
V. <i>Note on a modification of the apparatus employed for one of Ampère's fundamental experiments in electro-dynamics</i> . . . . . Proceedings of the Royal Society of Edinburgh, 1861.	35
VI. <i>Formulae connected with small continuous displacements of the particles of a medium</i> . . . . . Proceedings of the Royal Society of Edinburgh, 1862.	37
VII. <i>Note on a quaternion transformation</i> . . . . . Proceedings of the Royal Society of Edinburgh, 1863.	43

	PAGE
VIII. <i>On the law of frequency of error.</i> . . . . .	47
Transactions of the Royal Society of Edinburgh, Vol. xxiv., 1865.	
IX. <i>On the application of Hamilton's characteristic function to special cases of constraint</i> . . . . .	54
Transactions of the Royal Society of Edinburgh, Vol. xxiv., 1865.	
X. <i>Note on the reality of the roots of the symbolical cubic which expresses the properties of a self-conjugate linear and vector function</i> . . . . .	74
Proceedings of the Royal Society of Edinburgh, 1867.	
XI. <i>Note on a celebrated geometrical problem</i> . . . . .	76
Proceedings of the Royal Society of Edinburgh, 1867.	
XII. <i>Note on the hodograph</i> . . . . .	78
Proceedings of the Royal Society of Edinburgh, 1867.	
XIII. <i>Physical proof that the geometric mean of any number of positive quantities is less than the arithmetic mean</i> . . . . .	83
Proceedings of the Royal Society of Edinburgh, 1868.	
XIV. <i>On the dissipation of energy</i> . . . . .	84
Proceedings of the Royal Society of Edinburgh, 1868.	
XV. <i>On the rotation of a rigid body about a fixed point</i> . . . . .	86
Transactions of the Royal Society of Edinburgh, Vol. xxv., 1868.	
XVI. <i>Note on electrolytic polarization</i> . . . . .	128
Proceedings of the Royal Society of Edinburgh, 1869.	
XVII. <i>On the steady motion of an incompressible fluid in two dimensions.</i> . . . . .	132
Proceedings of the Royal Society of Edinburgh, 1870.	
XVIII. <i>On the most general motion of an incompressible fluid</i> . . . . .	134
Proceedings of the Royal Society of Edinburgh, 1870.	

	PAGE
XIX. <i>On Green's and other allied theorems</i> . . . . .	136
Transactions of the Royal Society of Edinburgh, Vol. xxvi., 1870.	
XX. <i>Note on linear partial differential equations</i> . . . . .	151
Proceedings of the Royal Society of Edinburgh, 1870.	
XXI. <i>Note on linear differential equations in quaternions</i> . . . . .	153
Proceedings of the Royal Society of Edinburgh, 1870.	
XXII. <i>On some quaternion integrals. Parts I. and II.</i> . . . . .	159
Proceedings of the Royal Society of Edinburgh, 1870.	
XXIII. <i>Address to Section A of the British Association</i> . . . . .	164
British Association Report, Edinburgh, 1871.	
XXIV. <i>Note on a singular property of the retina</i> . . . . .	174
Proceedings of the Royal Society of Edinburgh, 1872.	
XXV. <i>On orthogonal isothermal surfaces. Part I.</i> . . . . .	176
Transactions of the Royal Society of Edinburgh, read 1866; revised and improved, 1872.	
XXVI. <i>Note on the strain-function</i> . . . . .	194
Proceedings of the Royal Society of Edinburgh, 1872.	
XXVII. <i>On a question of arrangement and probabilities</i> . . . . .	199
Proceedings of the Royal Society of Edinburgh, 1873.	
XXVIII. <i>Thermo-electricity</i> . . . . .	206
Abstract of the Rede Lecture delivered in the Senate House, Cambridge, 1873. Nature, Vol. viii.	
XXIX. <i>First approximation to a thermo-electric diagram</i> . . . . .	218
Transactions of the Royal Society of Edinburgh, Vol. xxvii., 1873. (Plates I, II, III.)	
XXX. <i>Note on the transformation of double and triple integrals.</i>	234
Proceedings of the Royal Society of Edinburgh, 1873.	

	PAGE
XXXI. <i>Note on the various possible expressions for the force exerted by an element of one linear conductor on an element of another . . . . .</i>	237
Proceedings of the Royal Society of Edinburgh, 1873.	
XXXII. <i>On a singular theorem given by Abel . . . . .</i>	245
Proceedings of the Royal Society of Edinburgh, 1874.	
XXXIII. <i>On a fundamental principle in statics . . . . .</i>	247
Proceedings of the Royal Society of Edinburgh, 1874.	
XXXIV. <i>On the application of Sir W. Thomson's dead-beat arrangement to chemical balances . . . . .</i>	249
Proceedings of the Royal Society of Edinburgh, 1875.	
XXXV. <i>On the linear differential equation of the second order . . . . .</i>	250
Proceedings of the Royal Society of Edinburgh, 1876.	
XXXVI. <i>On a possible influence of magnetism on the absorption of light, and some correlated subjects . . . . .</i>	255
Proceedings of the Royal Society of Edinburgh, 1876.	
XXXVII. <i>Force . . . . .</i>	256
Evening Lecture at British Association (Glasgow Meeting). Nature, 1876.	
XXXVIII. <i>Some elementary properties of closed plane curves . . . . .</i>	270
Messenger of Mathematics, New Series, No. 69. 1876.	
XXXIX. <i>On Knots . . . . .</i>	273
Transactions of the Royal Society of Edinburgh, 1876-7. Revised 1877. (Plates IV, V.)	
XL. <i>On Knots. Part II. . . . .</i>	318
Transactions of the Royal Society of Edinburgh, Vol. xxxii., 1884. (Plate VI.)	

XL I.	<i>On Knots. Part III.</i> . . . . .	335
	Transactions of the Royal Society of Edinburgh, 1885. (Plates VII, VIII, IX.)	
XL II.	<i>Note on the effect of heat on infusible impalpable powders</i>	348
	Proceedings of the Royal Society of Edinburgh, 1877.	
XL III.	<i>Note on an identity.</i> . . . . .	349
	Proceedings of the Royal Society of Edinburgh, 1877.	
XL IV.	<i>Note on vector conditions of integrability.</i> . . . . .	352
	Proceedings of the Royal Society of Edinburgh, 1877.	
XL V.	<i>Note on a geometrical theorem.</i> . . . . .	357
	Proceedings of the Royal Society of Edinburgh, 1878.	
XL VI.	<i>Note on the surface of a body in terms of a volume integral.</i> . . . . .	360
	Proceedings of the Royal Society of Edinburgh, 1878.	
XL VII.	<i>Note on the strength of the currents required to work a telephone</i> . . . . .	361
	Proceedings of the Royal Society of Edinburgh, 1878.	
XL VIII.	<i>Thermal and electric conductivity</i> . . . . .	363
	Transactions of the Royal Society of Edinburgh, Vol. xxviii. 1878.	
XL IX.	<i>Note on electrolytic conduction.</i> . . . . .	393
	Proceedings of the Royal Society of Edinburgh, 1878.	
L.	<i>Note on a mode of producing sounds of very great intensity</i>	394
	Proceedings of the Royal Society of Edinburgh, 1878.	
LI.	<i>Obituary notice of James Clerk-Maxwell.</i> . . . . .	396
	Proceedings of the Royal Society of Edinburgh, 1879.	

	PAGE
LII. <i>Mathematical notes</i> . . . . .	402
Proceedings of the Royal Society of Edinburgh, 1880.	
LIII. <i>Note on the theory of the 15 puzzle</i> . . . . .	406
Proceedings of the Royal Society of Edinburgh, 1880.	
LIV. <i>Note on a theorem in geometry of position</i> . . . . .	408
Transactions of the Royal Society of Edinburgh, 1880. (Plate X.)	
LV. <i>On Minding's theorem</i> . . . . .	412
Transactions of the Royal Society of Edinburgh, 1880.	
LVI. <i>A rotatory polarization spectroscopie of great dispersion</i> . . . . .	423
Nature, Vol. xxii., 1880.	
LVII. <i>Note on a singular problem in kinetics.</i> . . . . .	425
Proceedings of the Royal Society of Edinburgh, 1881.	
LVIII. <i>On mirage</i> . . . . .	427
Transactions of the Royal Society of Edinburgh, Vol. xxx., 1881. (Plate XI.)	
LIX. <i>Solar chemistry</i> . . . . .	454
Nature, Vol. xxiv., 1881.	
LX. <i>The pressure errors of the Challenger thermometers</i> . . . . .	457
Challenger Narrative, Vol. II., Appendix A. 1881. (Plate XII.)	



## I.

QUATERNION INVESTIGATIONS CONNECTED WITH  
FRESNEL'S WAVE-SURFACE.[*Quarterly Journal of Mathematics, May, 1859.*]

1. THOUGH the following investigation of various equations and properties of Fresnel's Wave-Surface is my own, I must premise that I owe much besides the Calculus employed to Sir W. R. Hamilton. I was induced to attack the question by a passage in his *Lectures* (p. 687) which, he has since informed me, referred principally to the  $[\iota, \kappa]$  equation (28) of which he had long been in possession, and at which I had recently arrived independently. The application to this question of the *separable* symbol of operation of his VIIth Lecture, and the very elegant symbolical equation of the wave (39) deduced by its use, were recently communicated by him to the Royal Irish Academy.

Much of the work might have been considerably shortened, such for instance as that in Art. [12], where the system of equations giving the wave by its tangent plane is changed to another giving it by points. But these original methods have been preserved, partly from a fear of unconsciously borrowing from MS. investigations which Sir W. R. Hamilton has lately communicated to me, and partly because, as they stand, they introduce a good many equations whose interpretation is not without interest. I have not carried the inquiry in any case farther than the immediate interpretation of the various equations. Particulars, such as the directions of vibration at the cusps and along the ridges, for instance, can be easily deduced without analysis from the general results. I reserve for another occasion simple quaternion solutions of some interesting problems connected with the passage of light through doubly-refracting media.

As to the Calculus of Quaternions in general, I must remark, though I have only very recently taken it up, that it appears to me to possess in a marvellous

degree the attributes of simplicity and suggestiveness. The treatment of the wave-surface is perhaps not a question in which its superiority over Cartesian methods is at once so marked, as it is in all cases where no direction in space is regarded as preeminent. Still it is worthy of notice that the *three* directions of the axes of elasticity may be at once reduced to *two* reference lines (the wave, or the ray, axes) and a still farther reduction obtained by the introduction of a certain linear and vector operation. Equations ( $\eta$ ) and those in 17, 23, and 24 below, belonging to the Ellipsoids, Fresnel's Surface of Elasticity, and the Wave, are striking instances of such simplification.

A few quaternion results, which will be useful in the subsequent transformations, may first be noticed.

2. If the vector semiaxes of an ellipsoid be  $ai, bj, ck$  (where  $i, j, k$  are the quaternion rectangular vector units), its equation is

$$\frac{(Si\rho)^2}{a^2} + \frac{(Sj\rho)^2}{b^2} + \frac{(Sk\rho)^2}{c^2} = 1 \dots\dots\dots(\alpha),$$

which is in fact the same as the Cartesian equation

$$\frac{x^2}{a^2} + \frac{y^2}{b^2} + \frac{z^2}{c^2} = 1.$$

But Sir W. R. Hamilton (*Quaternions*, p. 467) has shown that it may also be presented in the form

$$T(\iota\rho + \rho\kappa) = \kappa^2 - \iota^2,$$

where

$$\left. \begin{aligned} \iota &= \frac{ac}{2} \sqrt{\left(\frac{a+c}{a-c}\right) \left\{ \frac{\sqrt{(a^2-b^2)}}{ab} i + \frac{\sqrt{(b^2-c^2)}}{bc} k \right\}} \\ \kappa &= -\frac{ac}{2} \sqrt{\left(\frac{a-c}{a+c}\right) \left\{ \frac{\sqrt{(a^2-b^2)}}{ab} i - \frac{\sqrt{(b^2-c^2)}}{bc} k \right\}} \end{aligned} \right\} \dots\dots\dots(\beta),$$

supposing  $a > b > c$ .  $\iota$  and  $\kappa$  are thus vectors perpendicular to the planes of the circular sections of ( $\alpha$ ).

It is easy to show by actual substitution that with the above values of  $\iota, \kappa$ , we have *identically*

$$\frac{(Si\rho)^2}{a^2} + \frac{(Sj\rho)^2}{b^2} + \frac{(Sk\rho)^2}{c^2} = \frac{T^2(\iota\rho + \rho\kappa)}{(\kappa^2 - \iota^2)^2} \dots\dots\dots(\gamma).$$

If we have a reciprocal ellipsoid, whose vector semiaxes are  $i/a, j/b, k/c$ , its equation is one of the following:

$$a^2 (Si\rho)^2 + b^2 (Sj\rho)^2 + c^2 (Sk\rho)^2 = \frac{T^2(\iota'\rho + \rho\kappa')}{(\kappa'^2 - \iota'^2)^2} = 1 \dots\dots\dots(\delta),$$

where the first equality is an identity, and  $\iota', \kappa'$  are what  $\iota, \kappa$  become when in ( $\beta$ ),  $1/a, 1/b, 1/c$  are put for  $a, b, c$  respectively.

If we differentiate ( $\gamma$ ), we get

$$\left. \begin{aligned} \frac{Si\rho Si\rho'}{a^2} + \frac{Sj\rho Sj\rho'}{b^2} + \frac{Sk\rho Sk\rho'}{c^2} &= \frac{S(\iota\rho + \rho\kappa)(\rho'\iota + \kappa\rho')}{(\kappa^2 - \iota^2)^2} \\ &= \frac{S(\iota\rho' + \rho'\kappa)(\rho\iota + \kappa\rho)}{(\kappa^2 - \iota^2)^2} \end{aligned} \right\} \dots\dots\dots(\epsilon),$$

which also is an identity, whatever be  $\rho$  and  $\rho'$ .

A similar expression may of course be derived from ( $\delta$ ). And they may be verified by actual substitution of the values of  $\iota$ ,  $\kappa$ , or  $\iota'$ ,  $\kappa'$ .

It is easy from equations ( $\beta$ ) to show that

$$\begin{aligned} T^2\iota + T^2\kappa &= \frac{1}{2}(a^2 + c^2), \\ \kappa^2 - \iota^2 &= ac, \\ 2TiT\kappa &= \frac{1}{2}(a^2 - c^2), \\ T(\iota - \kappa) &= \frac{ac}{b}, \\ T.V\iota\kappa &= \frac{ac}{2b^2} \sqrt{(a^2 - b^2)} \sqrt{(b^2 - c^2)}, \end{aligned}$$

formulae which we shall afterwards employ to interpret certain quaternion expressions.

3. Another very useful form of the equations of these ellipsoids is found thus. Let  $\theta$  be any vector, and let

$$\theta \text{ or } \phi\theta = -aiSi\theta - bjSj\theta - ckSk\theta.$$

Then evidently

$$\left. \begin{aligned} \underline{\theta} &= \phi^2\theta = -a^2iSi\theta - b^2jSj\theta - c^2kSk\theta \\ \underline{\theta} &= \phi^m\theta = -a^m iSi\theta - \&c. \\ \underline{\theta} &= \phi^{-1}\theta = -\frac{1}{a} iSi\theta - \&c., \text{ and so on.} \end{aligned} \right\} \dots\dots\dots(\zeta).$$

And we see that ( $\alpha$ ) and ( $\delta$ ) take the very simple forms

$$\left. \begin{aligned} T\bar{\rho} &= 1 \text{ or } T\phi^{-1}\rho = 1 \\ T\rho &= 1 \text{ or } T\phi\rho = 1 \end{aligned} \right\} \dots\dots\dots(\eta).$$

and

These functions are possessed of the following general and useful property,  $\theta$  and  $\psi$  being any two vectors:

$$S. \underset{m \ n}{\theta \psi} = S. \phi^m \theta \phi^n \psi = S. \underset{p \ q}{\theta \psi} = S. \phi^p \theta \phi^q \psi \dots\dots\dots(\theta),$$

if  $m + n = p + q$ , where  $m$ ,  $n$ ,  $p$ , and  $q$  may be any real quantities whatever.

Hence, for example,  $S \cdot \theta \psi = S \cdot \theta \bar{\psi} = S \cdot \theta \bar{\bar{\psi}} = S \cdot \bar{\theta} \psi = \&c.$  Another such property is

$$S \cdot \underset{mnp}{\theta \theta \theta} = Si\theta S^j \theta Sk\theta \begin{vmatrix} a^m & b^m & c^m \\ a^n & b^n & c^n \\ a^p & b^p & c^p \end{vmatrix}.$$

In this notation  $\phi^{-2}$  is Sir W. R. Hamilton's linear and vector function (*Quaternions*, p. 480).

4. If  $f(\rho) = 0$  be the scalar equation of a surface, containing as an arbitrary constant a vector  $\alpha$  which satisfies the equation

$$\alpha^2 = -1,$$

it is required to find the envelope of  $f(\rho) = 0$  subject to the variation of  $\alpha$ .

Let  $Svd\alpha = 0$

be the derived equation of  $f(\rho) = 0$ , supposing  $\alpha$  alone to vary, then we have also

$$Sada = 0,$$

and as  $d\alpha$  is indeterminate these two equations give

$$\alpha \parallel v \text{ or } V\alpha v = 0 \dots \dots \dots (\lambda).$$

This vector equation is equivalent to *two* scalar equations, and these, combined with  $f(\rho) = 0$  and  $\alpha^2 + 1 = 0$ , will theoretically be sufficient to eliminate the *three* indeterminate scalars involved in  $\alpha$ , and so to give  $F(\rho) = 0$ , the required equation of the envelope. This corresponds in ordinary Geometry of Three Dimensions to the finding the envelope of a series of surfaces whose common equation involves two arbitrary constants; since  $\alpha$ , with the condition  $T\alpha = 1$ , contains only two indeterminates.

5. Assuming then, in a biaxial crystal, the existence of three mutually perpendicular axes of elasticity (Griffin's *Tract*, pp. 3, 4), take  $i, j, k$  in their directions, and let a particle of ether be displaced in the direction of  $\omega$ , where

$$\omega^2 = -1 \dots \dots \dots (1),$$

and through a space  $t$ , in a wave-front whose normal is  $\alpha$ , where

$$\alpha^2 = -1 \dots \dots \dots (2).$$

We have therefore

$$S\omega\alpha = 0 \dots \dots \dots (3).$$

The force of restitution called into play is

$$t(a^2iSi\omega + b^2jSj\omega + c^2kSk\omega) = -t\varpi \dots \dots \dots (4),$$

and the resolved part of this perpendicular to  $\omega$  must be, on Fresnel's hypothesis, perpendicular to the wave-front or  $\parallel \alpha$ .

Hence

$$\varpi^{-1}(a^2Vi\varpi Si\varpi + b^2Vj\varpi Sj\varpi + c^2Vk\varpi Sk\varpi) \parallel \alpha,$$

or 
$$a^2Si\varpi Si\varpi\alpha + b^2Sj\varpi Sj\varpi\alpha + c^2Sk\varpi Sk\varpi\alpha = 0 \dots\dots\dots(5),$$

or, by (ε), 
$$S.(i'\varpi\alpha + \varpi\alpha\kappa')(\varpi i' + \kappa'\varpi) = 0,$$

or 
$$S.i'\varpi\alpha\kappa'\varpi = 0 \dots\dots\dots(6),$$

or, by (3) or (5), 
$$S.\kappa'\varpi\alpha i'\varpi = 0 \dots\dots\dots(6').$$

These cones of the second order (6) and (6') are cut by (3) in two common generating lines; and, if  $\varpi$  be one of these, the form of the equations shows that  $\varpi\alpha$  is the other. Hence, for any given wave-front there are two directions of vibration perpendicular to each other.

6. By (6) 
$$S.\varpi i'\varpi\alpha\kappa' = 0.$$

Hence  $\alpha, \kappa'$ , and  $\varpi i'\varpi$  are coplanar, and as  $\varpi \perp \alpha$  it is equally inclined to  $V i'\alpha$  and  $V \kappa'\alpha$ .

For if  $I', K'$ , and  $A$  be the projections of  $i', \kappa', \alpha$  on the unit-sphere,  $BC$  the great circle whose pole is  $A$  ( $AI'C$  and  $AK'B$  being arcs of great circles), we are

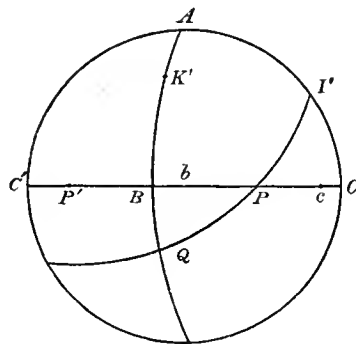

to find for the projections of the values of  $\varpi$  on the sphere points  $P$  and  $P'$ , such that if  $I'P$  be produced till  $\widehat{PQ} = \widehat{I'P}$ ,  $Q$  may lie in  $AK'$ . Hence, evidently,  $\widehat{CP} = \widehat{PB}$  or  $\widehat{CP}' = \widehat{P'B}$ , which proves the above, since the projections of  $V i'\alpha$  and  $V \kappa'\alpha$  on the sphere are points  $b$  and  $c$  in  $BC$ ,  $90^\circ$  distant from  $C$  and  $B$  respectively.

7. Or thus 
$$S\varpi\alpha = 0,$$

$$S.\varpi V.\alpha i'\varpi\kappa' = 0;$$

therefore

$$\begin{aligned} x\varpi &= V.\alpha V.\alpha i'\varpi\kappa' \text{ (where } x \text{ is a scalar)} \\ &= V.\alpha V.\alpha V i'\varpi\kappa' \\ &= -V i'\varpi\kappa' - \alpha S.\alpha V i'\varpi\kappa'; \end{aligned}$$

therefore  $(S'i' \kappa' - x) \varpi = (i' + \alpha S i' \alpha) S \kappa' \varpi + (\kappa' + \alpha S \kappa' \alpha) S i' \varpi.$

Operate by  $S i'$  and we obtain

$$(x + S i' \alpha S \kappa' \alpha) S i' \varpi = \{i'^2 \alpha^2 - (S i' \alpha)^2\} S \kappa' \varpi = T^2 V i' \alpha S \kappa' \varpi.$$

Hence, by symmetry,

$$\frac{S \kappa' \varpi}{S i' \varpi} T^2 V i' \alpha = \frac{S i' \varpi}{S \kappa' \varpi} T^2 V \kappa' \alpha,$$

or

$$\frac{S i' \varpi}{T V i' \alpha} \pm \frac{S \kappa' \varpi}{T V \kappa' \alpha} = 0,$$

$$S \cdot \varpi \left( \frac{i'}{T V i' \alpha} \pm \frac{\kappa'}{T V \kappa' \alpha} \right) = 0,$$

and as

$$S \varpi \alpha = 0,$$

$$\varpi = U (U V i' \alpha \pm U V \kappa' \alpha) \dots \dots \dots (7).$$

The planes of polarization, therefore (whose normals on Fresnel's hypothesis are  $\varpi$  and  $\varpi \alpha$  respectively), bisect the angles contained by planes passing through the normal to the wave-front and the optic axes ( $i', \kappa'$ ).

8. The force of restitution (4) resolved along the direction of displacement is

$$t \varpi^{-1} \{a^2 (S i \varpi)^2 + b^2 (S j \varpi)^2 + c^2 (S k \varpi)^2\},$$

or

$$- t \varpi \{a^2 (S i \varpi)^2 + \dots\} = t \varpi \varpi^2.$$

Hence the normal velocity of propagation is

$$v = \sqrt{\{a^2 (S i \varpi)^2 + \dots\}} = (\kappa'^2 - i'^2)^{-1} T (i' \varpi + \varpi \kappa') = T \varpi \dots \dots \dots (8).$$

But

$$T^2 (i' \varpi + \varpi \kappa') = (i' - \kappa')^2 \varpi^2 + 4 S i' \varpi S \kappa' \varpi = - (i' - \kappa')^2 \mp \frac{2 (S \cdot i' \kappa' \alpha)^2}{(T \mp S) \cdot V i' \alpha V \kappa' \alpha} \text{ by (7).}$$

But

$$(T^2 - S^2) \cdot V i' \alpha V \kappa' \alpha = - V^2 \cdot V i' \alpha V \kappa' \alpha = (S \cdot i' \kappa' \alpha)^2;$$

therefore

$$T^2 (i' \varpi + \varpi \kappa') = - (i' - \kappa')^2 \mp 2 (T \pm S) \cdot V i' \alpha V \kappa' \alpha \dots \dots \dots (9).$$

Hence, if  $v_1^2, v_2^2$  be the squares of the velocities of the two waves whose vibrations are perpendicular to  $\alpha$ ,

$$v_1^2 - v_2^2 = 4 (\kappa'^2 - i'^2)^{-2} T \cdot V i' \alpha V \kappa' \alpha \propto \sin \widehat{i' \alpha} \sin \widehat{\kappa' \alpha}.$$

Or, the difference of the squares of the velocities of the two waves varies as the product of the sines of the angles between the normal to the wave-front and the optic axes ( $i', \kappa'$ ).

9. For the tangent plane to the wave-surface of Fresnel, we have therefore

$$\left. \begin{aligned} S\alpha\rho &= -v = -(\kappa'^2 - l'^2)^{-1} T(l'\varpi + \varpi\kappa') = -T\underline{\varpi} & (10) \\ \varpi &= U(UVl'\alpha \pm UV\kappa'\alpha) & (7) \\ \alpha^2 &= -1 & (2) \end{aligned} \right\}.$$

From (10) and (7) we might eliminate  $\varpi$ , and so reduce the determination of the required equation to an application of the method of 4. But, as this process would lead to results of considerable complexity, it is advisable to take a different course.

10. It is easy to form directly the equation of the *reciprocal* of the wave-surface, or the surface of normal slowness.

For the length of the perpendicular from the origin on the tangent plane to Fresnel's wave is, by (10), (8),

$$(\kappa'^2 - l'^2)^{-1} T(l'\varpi + \varpi\kappa').$$

Therefore, if  $\rho$  be the vector of the point in the surface of normal slowness which corresponds to the tangent plane (10) to the wave,

$$U\rho = \alpha \dots\dots\dots (11),$$

$$\frac{1}{T\rho} = (\kappa'^2 - l'^2)^{-1} T(l'\varpi + \varpi\kappa') \dots\dots\dots (12),$$

or, by (9), 
$$\frac{1}{T\rho^2} = (\kappa'^2 - l'^2)^{-2} \{- (l' - \kappa')^2 \mp 2(T \pm S) \cdot V l' \alpha V \kappa' \alpha\}.$$

Hence 
$$(\kappa'^2 - l'^2)^2 = (l' - \kappa')^2 \rho^2 \mp 2(T \pm S) \cdot V l' \rho V \kappa' \rho$$

(or, by an obvious transformation,) 
$$= \{S(l' - \kappa')\rho\}^2 + (TVl'\rho \mp TV\kappa'\rho)^2 \dots\dots\dots (13).$$

We shall leave this result in the meantime, in order to obtain the equation of this surface in a form independent of the  $(l', \kappa')$  transformation.

11. By the help of 3, it is evident that, since by (3)  $\varpi\alpha$  is a vector, (5) may be written thus

$$S \cdot \underline{\varpi}\varpi\alpha = 0 \dots\dots\dots (14).$$

Hence the equations for determining that of the surface of normal slowness may be written, remembering (10), (11), and (12),

$$\left. \begin{aligned} S\underline{\varpi}\rho &= 0 \\ S \cdot \underline{\varpi}\varpi\rho &= 0 \\ T\underline{\varpi} &= 1 \\ T\underline{\varpi}T\rho &= T\underline{\varpi} \end{aligned} \right\} \dots\dots\dots (15),$$

from which it is required to eliminate  $\varpi$ . This we might now proceed to do, but it seems preferable to form for the wave-surface itself the equations corresponding to (15), and we shall thus perform the elimination for both surfaces at once.



12. With the present notation the equations, of the tangent plane to the wave, and the conditions, are

$$\left. \begin{aligned} S\alpha\rho &= -T\omega & (10) \\ S\omega\alpha &= 0 & (3) \\ S.\omega\omega\alpha &= 0 & (5) \text{ or } (14) \\ \alpha^2 &= -1 & (2) \\ \omega^2 &= -1 & (1) \end{aligned} \right\} \dots\dots\dots (16).$$

Hence if

$$\alpha' = d\alpha, \quad \omega' = d\omega,$$

$$\left. \begin{aligned} S\alpha'\omega &= -S\omega'\alpha \\ S.\alpha'\omega\omega &= -S\omega'\omega\alpha - S.\omega'\alpha\omega \\ S\alpha'\alpha &= 0 \end{aligned} \right\} :$$

therefore

$$\begin{aligned} \alpha'S.\omega\alpha V\omega\omega &= -\alpha'S\alpha\omega \\ &= -\omega\alpha S.\omega'\omega\alpha - \omega\alpha S.\omega'\alpha\omega - (V.\alpha V\omega\omega S\omega'\alpha) = \omega S\alpha\omega S\omega'\alpha. \end{aligned}$$

But, by (10),

$$S\alpha'\rho = \frac{1}{T\omega} S\omega'\omega,$$

and, by (1),

$$S\omega'\omega = 0.$$

Hence, by (λ),  $x$  being a scalar,

$$x\omega = \frac{\omega}{T\omega} S\alpha\omega - \{\omega\alpha + V\alpha\omega\} S.\omega\alpha\rho - \alpha S\omega\rho S\alpha\omega \dots\dots\dots(17).$$

Operate by  $S.\omega\alpha$

$$0 = -S.\omega\alpha\rho \{\omega\alpha^2 - \omega^2\} \dots\dots\dots(18).$$

Hence, generally,

$$S.\omega\alpha\rho = 0 \dots\dots\dots(19).$$

Attending to (19), and operating on (17) by  $S.\omega$  and  $S.\alpha$ ,

$$\left. \begin{aligned} x &= T\omega S\alpha\omega \\ 0 &= S\alpha\omega + T\omega S\omega\rho \end{aligned} \right\} \dots\dots\dots(20).$$

And (17) becomes

$$\omega T\omega = \frac{\omega}{T\omega} - \alpha S\omega\rho \dots\dots\dots(21).$$

Operating on (21) by  $S.\rho$ ,  $S.\rho\alpha$ , and  $S.\omega\rho$  separately, we obtain

$$S\omega\rho = 0 \dots\dots\dots(22),$$

$$S.\omega\alpha\rho = 0 \dots\dots\dots(23),$$

$$S.\omega\omega\rho = 0 \dots\dots\dots(24).$$

From (22) and (23)

$$y\rho = \omega V\alpha\omega.$$

Operate by  $S. \alpha$

$$yT_{\underline{\omega}} = T^2V\alpha_{\underline{\omega}}.$$

.....  $S. \omega$

$$yS\omega\rho = -y \frac{S\alpha_{\underline{\omega}}}{T_{\underline{\omega}}} \text{ (by (20))} = -T^2_{\underline{\omega}}S\alpha_{\underline{\omega}};$$

therefore

$$y = T^3_{\underline{\omega}},$$

and

$$T^2_{\underline{\omega}} = TV\alpha_{\underline{\omega}};$$

therefore

$$T^3_{\underline{\omega}}T\rho = T_{\underline{\omega}}TV\alpha_{\underline{\omega}},$$

or

$$T\rho T_{\underline{\omega}} = T_{\underline{\omega}} \dots\dots\dots(25).$$

Put now for simplicity

$$\left. \begin{aligned} U_{\underline{\omega}} = \omega, \text{ or } \underline{\omega} = \omega T_{\underline{\omega}} \\ \underline{\omega} = \bar{\omega} T_{\underline{\omega}} \\ \omega = \bar{\omega} T_{\underline{\omega}} \end{aligned} \right\} \dots\dots\dots(26).$$

therefore

and

And our system of equations, freed from differentials, becomes,

$$\left. \begin{aligned} \text{from (22),} & \quad S\omega\rho = 0 \\ \text{(24),} & \quad S. \bar{\omega}\omega\rho = 0 \\ \text{(26),} & \quad T\omega = 1 \\ \text{(26) and (25),} & \quad T\rho T_{\bar{\omega}} = T_{\bar{\omega}} \end{aligned} \right\} \dots\dots\dots(27).$$

A glance at (27) and (15) shows that the equation of the Wave-Surface differs from that of the surface of normal slowness merely by the substitution of  $(-)$  for  $(-)$ , &c., or of  $1/a, 1/b, 1/c$  for  $a, b, c$  respectively; and hence, by (13), one form of the equation of the Wave-Surface is

$$(\kappa^2 - \iota^2)^2 = \{S(\iota - \kappa)\rho\}^2 + (TV\iota\rho \mp TV\kappa\rho)^2 \dots\dots\dots(28).$$

13. We may obtain another form, which corresponds to the ordinary Cartesian equation, in the following manner:

$$\text{By (27)} \quad u\omega = \rho V\bar{\omega}\rho \dots\dots\dots(29),$$

where  $u$  is a scalar,

$$= \rho S\bar{\omega}\rho - \bar{\omega}\rho^2.$$

Operate by  $S. \bar{\omega}$

$$\begin{aligned} u\bar{\omega}^2 &= (S\bar{\omega}\rho)^2 - \bar{\omega}^2\rho^2 \\ &= V^2\bar{\omega}\rho. \end{aligned}$$

But by (29)

$$\begin{aligned} u^2 &= \rho^2 V^2\bar{\omega}\rho \\ &= u\rho^2\bar{\omega}^2 = u \text{ by (27)}. \end{aligned}$$

Hence,  $u = 1$  and

$$\omega = \rho S\bar{\omega}\rho - \bar{\omega}\rho^2 \dots\dots\dots(30).$$

Operate by  $S.i$

$$Si\omega = Si\rho S\bar{\omega}\rho - \rho^2 S\bar{i}\omega.$$

But

$$\bar{i} = \frac{1}{a^2} i \text{ by } (\zeta);$$

therefore

$$\left(1 + \frac{\rho^2}{a^2}\right) Si\omega = Si\rho S\bar{\omega}\rho,$$

and similarly with  $j$  and  $k$ .

Multiplying by  $Si\rho$ ,  $Sj\rho$ , and  $Sk\rho$  respectively, and remembering that

$$Si\rho Si\omega + Sj\rho Sj\omega + Sk\rho Sk\omega = -S\rho\omega = 0$$

by (27), we have

$$\frac{a^2 (Si\rho)^2}{a^2 + \rho^2} + \frac{b^2 (Sj\rho)^2}{b^2 + \rho^2} + \frac{c^2 (Sk\rho)^2}{c^2 + \rho^2} = 0 \dots\dots\dots(31),$$

which in Cartesian coordinates is, at once,

$$\frac{a^2 x^2}{a^2 - r^2} + \frac{b^2 y^2}{b^2 - r^2} + \frac{c^2 z^2}{c^2 - r^2} = 0,$$

(where  $r^2 = x^2 + y^2 + z^2$ ) the well-known form.

It is evident that from (15) we might have deduced for the surface of normal slowness an auxiliary equation similar to (30), viz.

$$\varpi = \rho S\varpi\rho - \varpi\rho^2 \dots\dots\dots(30'),$$

and thence found for the equation of that surface

$$\frac{(Si\rho)^2}{1 + a^2\rho^2} + \frac{(Sj\rho)^2}{1 + b^2\rho^2} + \frac{(Sk\rho)^2}{1 + c^2\rho^2} = 0 \dots\dots\dots(31').$$

14. It may be interesting to effect the elimination of  $\omega$  between (30) and the first equation in (27) without employing directly  $i, j, k$  or  $\iota, \kappa$ . For this purpose operate on (30) by  $S.\rho$  and  $S.\bar{\rho}$  successively, and we obtain

$$\left. \begin{aligned} S\omega (\rho - \bar{\rho}S\rho\rho + \bar{\rho}\rho^2) &= 0 \\ S\omega (\rho - \bar{\rho}\rho^2 + \rho\rho^2) &= 0 \\ S\omega\rho &= 0 \end{aligned} \right\}.$$

Also

$$S.\rho (\rho - \bar{\rho}S\rho\rho + \bar{\rho}\rho^2) (\rho - \bar{\rho}\rho^2 + \rho\rho^2) = 0,$$

or

$$S.\rho\rho\rho - \rho^2 S.\rho\rho\bar{\rho} - S\rho\rho S.\rho\bar{\rho}\rho + \rho^2 S.\rho\bar{\rho}\rho - \rho^2 \rho^2 S.\rho\bar{\rho}\bar{\rho} = 0 \dots\dots\dots(32),$$

which, by the formulæ in 3, is easily reduced to Fresnel's original form

$$(x^2 + y^2 + z^2)(a^2 x^2 + b^2 y^2 + c^2 z^2) - a^2(b^2 + c^2)x^2 - b^2(c^2 + a^2)y^2 - c^2(a^2 + b^2)z^2 + a^2 b^2 c^2 = 0,$$

if we put  $Si\rho = -x$ , &c. and note that

$$\frac{S.\rho\bar{\rho}\rho}{S.\rho\bar{\rho}\bar{\rho}} = (a + b)(b + c)(c + a).$$

15. *Fresnel's construction of the Wave by points.*

By (27)  $S. \bar{\omega}\omega\rho = 0.$

This is equivalent to

$$\left. \begin{aligned} S\omega'\bar{\omega} &= 0 \\ S\omega'\omega &= 0 \\ S\omega'\rho &= 0 \end{aligned} \right\}.$$

Now these are the equations we should find if we were to make  $T\omega$  a maximum or minimum under the two conditions  $T\bar{\omega} = 1$  and  $S\omega\rho = 0$ ,  $\rho$  being supposed constant, i.e. to find the greatest and least radii vectores of a diametral section of the ellipsoid  $T\bar{\omega} = 1$  made by the plane  $S\omega\rho = 0$ . Combining this with the two last equations of (27) we see that *if the ellipsoid, whose semi-axes are a, b, c, be constructed, and if through its centre perpendiculars be drawn to each diametral section, and their lengths be made equal to the semi-axes of the section, the locus of their extremities is the Wave.*

And it is obvious from (15) that the surface of normal slowness may be constructed in the same manner from the ellipsoid  $T\underline{\omega} = 1$  whose semi-axes are  $1/a, 1/b, 1/c$ .

16. *These ellipsoids are reciprocal.* This is easily seen thus:  $T\bar{\omega} = 1$ ; therefore  $S\bar{\omega}\omega' = 0$ , and hence the normal  $\nu = x\bar{\omega}$ . Operate by  $S\omega$

$$S\omega\nu = 1 = xS\omega\bar{\omega} = x\bar{\omega}^2 = -x;$$

therefore  $\nu = -\bar{\omega} \dots \dots \dots (\mu).$

Hence for the reciprocal surface

$$\bar{\omega} = \bar{\omega};$$

whence

$$\underline{\omega} = \omega;$$

and therefore

$$\underline{\omega}^2 = \bar{\omega}^2 = -1,$$

or

$$T\underline{\omega} = 1.$$

17. *Fresnel's surface of elasticity* is constructed by taking on each vector from the origin a portion proportional to the square root of the resolved part of the force of restitution corresponding to a *given* displacement parallel to the vector.

If then  $\rho$  be a vector of this surface, evidently

$$T\rho = T. U\rho,$$

or

$$T^2\rho = T\rho,$$

or finally

$$T(\rho^{-1}) = 1 \dots \dots \dots (\nu).$$

Comparing this with  $T\underline{\omega} = 1$ , it is clear that condirectional radii of the surface of elasticity and of this ellipsoid are reciprocal in length, which gives one means of constructing the former.

It is known also to be the locus of the foot of the perpendicular from the centre on the tangent plane to the other ellipsoid  $T\bar{\omega} = 1$ . In fact by  $(\mu) \nu$  in the latter is  $-\bar{\omega}$ ;

therefore  $\nu^{-1} = (-\bar{\omega})^{-1} = \rho$  of the required locus,

or  $\rho^{-1} = -\bar{\omega}$ ;

therefore  $(\rho^{-1}) = -\bar{\omega}$ ,

and  $T(\rho^{-1}) = 1$  as before.

The locus of the foot of the perpendicular from the centre on the tangent plane to  $T\bar{\omega} = 1$  may similarly be shown to have the equation  $T(\rho^{-1}) = 1$ , and to have with  $T\bar{\omega} = 1$  condirectional radii of reciprocal lengths.

18. It may be proper to give the interpretations of some of the equations noticed incidentally in these processes.

(14) for instance shows that  $\bar{\omega} \perp \bar{\omega}\alpha$  or that  $\underline{\omega\alpha} \perp \bar{\omega}$ ; that is, *the force of restitution for either direction of displacement in a plane front is perpendicular to the other direction*; or, interpreting it directly, *the force of restitution, the direction of displacement, and the normal to the front are coplanar*; which latter is, however, only another way of expressing the condition from which (14) or (5) was obtained.

(19) shows that *the ray, the normal to the front, and the direction of vibration are coplanar*, or, *the direction of vibration is the projection of the ray on the wave-front*. (23) throws *the force of restitution into the same plane*.

(20) shows that *the part of the force of restitution which is perpendicular to the wave-front is the product of the wave-velocity, and the projection of the ray-velocity on the wave-front*.

This is included in the two following which are given at once by (22) and (25).

*The direction of ray-propagation is perpendicular to the force of restitution.*

*That force is proportional to the product of the ray-, and wave-, velocities.*

19. The form (28) of the equation of the wave is well adapted for the exhibition of the cusps and ridges on which conical refraction depends.

If we suppose for instance

$$TV\iota\rho = TV\kappa\rho \dots\dots\dots(33),$$

(28) gives at once

$$S(\iota - \kappa)\rho = \pm(\kappa^2 - \iota^2)\dots\dots\dots(34),$$

or, the wave surface intersects the cone (33) in two *coincident* curves on each of the parallel planes (34), which latter therefore *touch* the wave along those curves. That the curves are *circles* will be seen by putting (33) in the form

$$(\kappa^2 - \iota^2)\rho^2 = (S\kappa\rho)^2 - (S\iota\rho)^2 \dots\dots\dots(33'),$$

whence, by (34),

$$\rho^2 = \mp S(\iota + \kappa) \rho \dots\dots\dots(34'),$$

the equations of two spheres passing through the centre of the wave, on which also lie the curves in question.

Taking the lower sign,

$$T\left(\rho - \frac{\iota + \kappa}{2}\right) = T' \frac{\iota + \kappa}{2},$$

and therefore the vector of its centre is  $+\frac{\iota + \kappa}{2}$ , and its radius is  $T' \frac{\iota + \kappa}{2}$ . Also, as

$$-S(\iota - \kappa)(\iota + \kappa) = \kappa^2 - \iota^2,$$

the plane (34) (lower sign) passes through the other extremity of the diameter drawn from the centre of the wave. Hence diameter of circular ridge on wave

$$\begin{aligned} &= TV . (\iota + \kappa) U(\iota - \kappa) \\ &= \frac{2TV\iota\kappa}{T(\iota - \kappa)} = \{\text{by 2}\} \\ &= \frac{\sqrt{(a^2 - b^2)}\sqrt{(b^2 - c^2)}}{b} \dots\dots\dots(35). \end{aligned}$$

Also (33') may be put in the form

$$S(\iota + \kappa) \rho S(\iota - \kappa) \rho = -(\kappa^2 - \iota^2) \rho^2,$$

showing that the cyclic normals of the internal cone are  $\iota + \kappa$  and  $\iota - \kappa$ . These are also evidently sides of the cone. And it is to be noticed that  $\iota - \kappa \parallel \iota'$  one of the optic axes or lines of single wave-velocity.

The angle of the cone in the plane of  $\iota, \kappa$  is evidently

$$\begin{aligned} &\cos^{-1} \{ -S . U(\iota - \kappa) U(\iota + \kappa) \} \\ &= \cos^{-1} . \frac{\kappa^2 - \iota^2}{T(\iota - \kappa) T(\iota + \kappa)} = \{\text{by 2}\} \\ &= \cos^{-1} . \frac{b^2}{\sqrt{\{b^2(a^2 + c^2) - a^2c^2\}}}; \end{aligned}$$

which may be verified by noting that the optic axis of length  $b$  is the cyclic normal and terminates in the circular ridge. Hence, angle of cone in plane of  $\iota, \kappa$  is

$$\tan^{-1} . \frac{\sqrt{(a^2 - b^2)}\sqrt{(b^2 - c^2)}}{b^2} \text{ by (35),}$$

which agrees with the above.

20. If in (28) we suppose  $\rho$  to coincide in direction with  $\iota$  or  $\kappa$  we find only one value of  $T\rho$ .  $U\iota$  and  $U\kappa$  are therefore the lines of single ray-velocity. It is sufficient to consider one of them. Let therefore

$$\rho_0 = xU\iota.$$

Then

$$\begin{aligned}
 (\kappa^2 - \iota^2)^2 &= x^2 \left\{ \frac{S^2(\iota - \kappa)\iota}{T^2} - V^2\kappa U\iota \right\} \\
 &= \frac{x^2}{T^2\iota} \{(\iota^2 - S\iota\kappa)^2 - V^2\iota\kappa\} \\
 &= -x^2(\iota^2 - 2S\iota\kappa + \kappa^2),
 \end{aligned}$$

or

$$x = \frac{\kappa^2 - \iota^2}{T(\iota - \kappa)} \text{ (taking the positive sign),}$$

and therefore

$$\rho_0 = \frac{\kappa^2 - \iota^2}{T(\iota - \kappa)} U\iota = bU\iota \text{ [by 2].}$$

To study the nature of the surface near the extremity of this vector put

$$\rho = \rho_0 + \varpi.$$

Substituting in (28), and keeping only terms which contain the *first* power of  $T\varpi$  (thus supposing  $T\varpi$  to be indefinitely small), we have easily

$$(\iota^2 - S\iota\kappa + \kappa^2)S\iota\varpi - \iota^2S\kappa\varpi \mp TV\iota\kappa TV\iota\varpi = 0 \dots\dots\dots (36),$$

which is evidently the equation of a cone of the second order.

For the sides of this cone, which lie in the plane of  $\iota, \kappa$ , we see at once that  $\iota V\iota\kappa$  is one, and corresponds to the upper sign. Assume for the other  $x\iota + \iota V\iota\kappa$  and we find

$$x = -\frac{2T^2V\iota\kappa}{T^2(\iota - \kappa)}.$$

The angle of the cone (in  $\iota, \kappa$ ) is therefore

$$\begin{aligned}
 &\cos^{-1}. S. U(\iota V\iota\kappa) U \left[ \iota V\iota\kappa \left\{ \frac{2V\iota\kappa}{T^2(\iota - \kappa)} + 1 \right\} \right] \\
 &= \cos^{-1}. \left[ -S. U \left\{ \frac{2V\iota\kappa}{T^2(\iota - \kappa)} + 1 \right\} \right] \\
 &= \cos^{-1}. \frac{-1}{\sqrt{\left\{ 1 + \frac{4T^2V\iota\kappa}{T^4(\iota - \kappa)} \right\}}} \\
 &= \cos^{-1}. \frac{-ac}{b\sqrt{(a^2 + c^2 - b^2)}} \text{ [by 2].}
 \end{aligned}$$

Equation (36) being written for a moment

$$S^2\delta\varpi = -V^2\iota\varpi \dots\dots\dots (36'),$$

it is required to find the equation of the complementary cone, or that whose sides are perpendicular to the tangent planes to the former.

(36') may be written

$$S^2\delta\varpi + S^2\iota\varpi = \iota^2\varpi^2;$$

therefore

$$S\varpi'(\delta S\delta\varpi + \iota S\iota\varpi - \varpi\iota^2) = 0.$$



Hence  $x\omega = \delta S\delta\varpi + \iota S\iota\varpi - \varpi\iota^2$  or  $\delta S\delta\varpi - \iota V\iota\varpi$  is a side of the new cone, as it is obviously perpendicular to  $\varpi$  and to  $\varpi'$ .

Therefore 
$$\iota S\iota\omega = S\iota\delta S\delta\varpi;$$

or 
$$S\delta\varpi = x \frac{S\iota\omega}{S\iota\delta};$$

so that 
$$\iota V\iota\varpi = x \left( \delta \frac{S\iota\omega}{S\iota\delta} - \omega \right);$$

therefore by (36')

$$S\iota\omega S\omega \{(\iota^2 - \delta^2)\iota + 2\delta S\iota\delta\} - \omega^2 S^2\iota\delta = 0,$$

which, if we notice that

$$S\iota\delta = \frac{T^2\iota T^2(\iota - \kappa)}{TV\iota\kappa},$$

and 
$$\iota^2 - \delta^2 = \frac{T^2\iota T^4(\iota - \kappa)}{T^2V\iota\kappa},$$

it is not difficult to reduce to

$$S\iota\omega S\{(\iota^2 + \kappa^2)\iota - 2\kappa\iota^2\} \omega - \omega^2 T^2\iota T^2(\iota - \kappa) = 0 \dots\dots\dots (37),$$

of which  $\iota$  and  $(\iota^2 + \kappa^2)\iota - 2\kappa\iota^2$  are the cyclic normals. These lines are evidently perpendicular to the tangents at the cusp to the circle and ellipse in the section of the wave by the plane of  $(\iota, \kappa)$ , since

$$S \cdot \iota \iota V\iota\kappa = 0,$$

and 
$$S \left\{ \iota V\iota\kappa - 2\iota \frac{T^2V\iota\kappa}{T^2(\iota - \kappa)} \right\} \{(\iota^2 + \kappa^2)\iota - 2\kappa\iota^2\} = 0.$$

21. The process in 20 gives the *four* cusps on the wave, but that in 19 gives only two of the circular ridges. The others however are easily found by the consideration that the ellipsoid equation, and analogously that of the wave-surface, retains its form if the tensors of  $\iota$  and  $\kappa$  be interchanged but their versors preserved.

22. *To find surfaces whose intersections with the wave touch the lines of vibration.*

Let  $\rho'$  be the tangential vector to such a curve of intersection, then

$$\rho' \parallel \varpi \parallel \bar{\omega} \text{ by (26).}$$

But 
$$S\rho\omega = 0 \text{ by (27);}$$

therefore 
$$S\rho\rho' = 0,$$

whose integral is evidently

$$T\rho = C,$$

*a set of ellipsoids concentric with, similar and similarly situated to,  $T\varpi = 1$ , that from which the index-surface was constructed.*

22'. To find surfaces whose intersections with the wave cut the lines of vibration at right angles.

Here evidently

$$\rho' \parallel \omega\alpha.$$

But

$$S\omega\alpha\rho = 0;$$

therefore

$$S\rho\rho' = 0,$$

or

$$T\rho = C \dots\dots\dots(38).$$

This is the equation of a set of spheres about the origin as centre, and we shall find presently that their curves of intersection with the wave are spherical conics.

23. As before

$$\omega = \rho S\bar{\omega}\rho - \bar{\omega}\rho^2 \quad (30),$$

or

$$(\phi^2 + \rho^2) \bar{\omega} = \rho S\bar{\omega}\rho.$$

Operate by  $S \cdot \rho(\phi^2 + \rho^2)^{-1}$  and we have at once

$$S\rho(\phi^2 + \rho^2)^{-1} \rho = 1 \dots\dots\dots(39),$$

the symbolical equation of the wave-surface, already referred to.

24. This may be put in the following forms:

$$S(\phi^2 + \rho^2)^{-\frac{1}{2}} \rho (\phi^2 + \rho^2)^{-\frac{1}{2}} \rho = 1,$$

or

$$T(\phi^2 + \rho^2)^{-\frac{1}{2}} \rho = \sqrt{-1},$$

or

$$\rho^{-2} S\rho \frac{\rho^2}{\phi^2 + \rho^2} \rho = 1,$$

that is

$$\rho^{-2} S\rho \frac{\phi^2 + \rho^2 - \phi^2}{\phi^2 + \rho^2} \rho = 1,$$

whence

$$S\rho \frac{\phi^2}{\phi^2 + \rho^2} \rho = 0 \dots\dots\dots(40),$$

and finally

$$T \frac{\phi}{\sqrt{(\phi^2 + \rho^2)}} \rho = 0 \dots\dots\dots(41).$$

If we seek the intersection of the wave with the concentric sphere (38), we find at once, by (39),

$$S\rho(\phi^2 - C^2)^{-1} \rho = 1,$$

a central surface of the second order, generally an hyperboloid, or

$$S\rho(C^{-2}\phi^2 - 1)^{-1} \rho = -\rho^2,$$

the equation of a cone of the second order.

25. Writing (39) in the form

$$S\rho\sigma = 1 \dots\dots\dots(42),$$

we have

$$\sigma = (\phi^2 + \rho^2)^{-1} \rho,$$

or

$$\rho = (\phi^2 + \rho^2) \sigma \dots\dots\dots(43).$$

Differentiating,

$$S(\rho\sigma' + \rho'\sigma) = 0,$$

and

$$\rho' = (\phi^2 + \rho^2) \sigma' + 2\sigma S\rho\rho';$$

therefore

$$\sigma' = (\phi^2 + \rho^2)^{-1} (\rho' - 2\sigma S\rho\rho') \dots\dots\dots(44),$$

and

$$S\sigma(\rho' - 2\sigma S\rho\rho') + S\rho'\sigma = 0,$$

or

$$2S\rho'(\sigma - \rho\sigma^2) = 0 \dots\dots\dots(45),$$

and if  $\nu$  be the reciprocal of the vector perpendicular on the tangent plane, let

$$x\nu = \sigma - \rho\sigma^2 = \sigma V\rho\sigma \dots\dots\dots(46);$$

we have

$$xS\rho\nu = x = 1 - \rho^2\sigma^2 = V^2\rho\sigma;$$

therefore

$$\nu = \sigma(V\rho\sigma)^{-1} \dots\dots\dots(47).$$

Hence

$$S\nu\sigma = 0$$

and

$$S.\nu\rho\sigma = 0$$

which show, first that  $\sigma$  is in the tangent plane, and second that it is coplanar with  $\nu$  and  $\rho$ ;  $\sigma$  is therefore *the direction of vibration*, or

$$\sigma \parallel \varpi; \text{ therefore } \phi^2\sigma = \frac{\phi^2}{\phi^2 + \rho^2} \rho \parallel \phi^2\varpi \parallel \underline{\varpi},$$

whence (40) becomes  $S\underline{\varpi}\rho = 0$ , (22), which shows that the *equation of the wave is an expression of the fact that the ray is perpendicular to the force of restitution*. This remark is due, I believe, to Sir W. R. Hamilton.

26. It may be noticed in passing that from (15) we should evidently find for the index-surface

$$\varpi = \rho S\underline{\varpi}\rho - \underline{\varpi}\rho^2 \dots\dots\dots(48),$$

whence, as before,

$$S.\rho(\phi^{-2} + \rho^2)^{-1}\rho = 1 \dots\dots\dots(49),$$

the symbolical equation of the latter, which differs from that of the wave merely by the change of  $\phi^2$  into  $\phi^{-2}$ , or of  $a, b, c$  into  $1/a, 1/b, 1/c$ .

Also from (3) and (14) we might at once deduce by a similar process

$$S\alpha(\phi^2 + \underline{\alpha}^2)^{-1}\alpha = 0 \dots\dots\dots(50),$$

which in the ordinary notation is the well-known equation

$$\frac{l^2}{a^2 - v^2} + \frac{m^2}{b^2 - v^2} + \frac{n^2}{c^2 - v^2} = 0.$$

27. Equation (46) is convenient for the investigation of the directions of the *lines of curvature* at any point of the wave.

Differentiating, we obtain

$$xv' + x'v = \sigma' - \rho'\sigma^2 - 2\rho S\sigma\sigma'$$

But for a line of curvature (*Quat.* p. 598)

$$S . \rho'vv' = 0.$$

Operating then by  $S . \rho'v$ , we have

$$S . \rho' (\sigma - \rho\sigma^2) (\sigma' - \rho'\sigma^2 - 2\rho S\sigma\sigma') = 0,$$

or

$$\begin{aligned} 0 &= S . \rho'\sigma\sigma' - 2S . \rho'\sigma\rho S\sigma\sigma' - \sigma^2 S . \rho'\rho\sigma' \\ &= S\sigma\rho S . \rho'\sigma\sigma' - 2S\sigma\sigma'S . \rho'\sigma\rho - \sigma^2 S . \rho'\rho\sigma' \\ &= S . \sigma (\rho S . \rho'\sigma\sigma' - 2\sigma'S . \rho'\sigma\rho - \sigma S . \rho'\rho\sigma') \\ &= S\sigma (\rho'S . \rho\sigma\sigma' - \sigma'S . \rho'\sigma\rho). \end{aligned}$$

$$\text{(For } \rho'S . \rho\sigma\sigma' = \rho S . \sigma\sigma'\rho' + \sigma S . \sigma'\rho\rho' + \sigma'S . \rho\sigma\rho')$$

therefore

$$0 = S\sigma\rho'S . \rho\sigma\sigma' + S\sigma\sigma'S . \rho\sigma\rho' = S . \rho'\sigma\sigma'V\rho\sigma.$$

Let  $(\phi^2 + \rho^2)^{-1}\sigma = \tau$ , and substitute for  $\sigma'$  from (44),

$$\begin{aligned} 0 &= S\sigma\rho'S . \rho\sigma (\phi^2 + \rho^2)^{-1} (\rho' - 2\sigma S\rho\rho') \\ &\quad + S\tau (\rho' - 2\sigma S\rho\rho') S . \rho\sigma\rho'. \end{aligned}$$

But  $\rho' + v$ ; therefore

$$\begin{aligned} \rho' &= x\sigma + yV\rho\sigma \\ &= x\sigma + y\theta \text{ suppose.} \end{aligned}$$

Hence

$$S\rho\theta = S\sigma\theta = 0.$$

Let  $(\phi^2 + \rho^2)^{-1}\theta = \mu$ ; and therefore  $S\sigma\mu = S\theta\tau$ . Hence

$$0 = x^2 T\sigma^2 S\theta\tau - y^2 T^2\theta S\theta\tau - xy T\sigma T\theta \left\{ \frac{T\sigma}{T\theta} S\theta\mu - \frac{T\theta}{T\sigma} S\sigma\tau \right\}.$$

Also

$$\rho' = xT\sigma U\sigma + yT\theta U\theta.$$

Hence if  $\beta$  be the angle at which the line of curvature crosses  $\sigma$  (the line of vibration)

$$\tan \beta = \frac{yT\theta}{xT\sigma}.$$

And with this the above equation gives

$$\begin{aligned} 0 &= 1 - \tan^2\beta - \tan\beta \frac{\frac{T\sigma}{T\theta} S\theta\mu - \frac{T\theta}{T\sigma} S\sigma\tau}{S\theta\tau}, \\ \tan 2\beta &= \frac{2 \tan \beta}{1 - \tan^2\beta} = \frac{2T\theta T\sigma S\theta\tau}{T\sigma^2 S\theta\mu - T\theta^2 S\sigma\tau} \\ &= \frac{2S . (\phi^2 + \rho^2)^{-\frac{1}{2}} U\sigma (\phi^2 + \rho^2)^{-\frac{1}{2}} UV\rho\sigma}{\{(\phi^2 + \rho^2)^{-\frac{1}{2}} UV\rho\sigma\}^2 - \{(\phi^2 + \rho^2)^{-\frac{1}{2}} U\sigma\}^2} \dots\dots\dots(51), \end{aligned}$$

which cannot = 0 unless

$$S\theta\tau = S \cdot \rho\sigma\tau = S \cdot \rho (\phi^2 + \rho^2)^{-1} \rho (\phi^2 + \rho^2)^{-2} \rho = 0,$$

or, by 3,

$$\begin{vmatrix} 1 & 1 & 1 \\ \frac{1}{a^2 + \rho^2} & \frac{1}{b^2 + \rho^2} & \frac{1}{c^2 + \rho^2} \\ \frac{1}{(a^2 + \rho^2)^2} & \frac{1}{(b^2 + \rho^2)^2} & \frac{1}{(c^2 + \rho^2)^2} \end{vmatrix} Si\rho Sjr Sk\rho = 0,$$

or

$$\begin{vmatrix} 1 & 1 & 1 \\ a^2 & b^2 & c^2 \\ a^4 & b^4 & c^4 \end{vmatrix} Si\rho Sjr Sk\rho = 0.$$

Hence the lines of curvature do not generally coincide with those of vibration.

*Queen's College, Belfast, April 2nd, 1859.*

## II.

### NOTE ON THE CARTESIAN EQUATION OF THE WAVE-SURFACE.

[*Quarterly Journal of Mathematics, August, 1859.*]

THE equation of the wave-surface

$$\left. \begin{aligned} \frac{a^2x^2}{a^2 - r^2} + \&c. = 0 \dots\dots\dots(1) \\ r^2 = x^2 + y^2 + z^2 \dots\dots\dots(2) \end{aligned} \right\},$$

where

may be written thus:

$$\left. \begin{aligned} \frac{a^2}{b^2c^2 - r_1^2} + \&c. = 0 \dots\dots\dots(3) \\ r_1^2 = a^2x^2 + b^2y^2 + c^2z^2 \dots\dots\dots(4) \end{aligned} \right\}.$$

where

I am not aware that this transformation has been given before. I was led to it by a quaternion process, not however so simple as the obvious algebraic verification.

Of course the corresponding equations of the index-surface, or the reciprocal of (1) with respect to

$$x^2 + y^2 + z^2 = 1 \dots\dots\dots(5)$$

may be written

$$\left. \begin{aligned} \frac{a^2}{1 - a^2r^2} + \&c. = 0 \dots\dots\dots(1') \\ r^2 = x^2 + y^2 + z^2 \dots\dots\dots(2') \end{aligned} \right\},$$

where

or

$$\left. \begin{aligned} \frac{x^2}{\frac{1}{b^2c^2} - r_2^2} + \&c. = 0 \dots\dots\dots(3') \end{aligned} \right\}.$$

where

$$r_2^2 = \frac{x^2}{a^2} + \frac{y^2}{b^2} + \frac{z^2}{c^2} \dots\dots\dots(4')$$

These equivalencies give a very simple proof of the following theorem, due, I believe, to Plücker.

“The wave-surface is its own reciprocal with respect to an ellipsoid whose semi-axes are  $\sqrt{(bc)}$ ,  $\sqrt{(ca)}$ , and  $\sqrt{(ab)}$ .”

The equation of this ellipsoid is

$$\frac{x^2}{bc} + \frac{y^2}{ca} + \frac{z^2}{ab} = 1 \dots\dots\dots(6).$$

Tangent planes to (6) from  $\xi$ ,  $\eta$ ,  $\zeta$  have for their plane of contact

$$\frac{\xi x}{bc} + \frac{\eta y}{ca} + \frac{\zeta z}{ab} = 1 \dots\dots\dots(7),$$

and the reciprocal of (7) with respect to (5) is the point

$$\xi' = \frac{\xi}{bc}, \quad \eta' = \&c.$$

Hence the reciprocal with respect to (5) of the reciprocal of (1) with respect to (6) has the equation

$$\frac{a^2 b^2 c^2 \xi'^2}{a^2 - (b^2 c^2 \xi'^2 + \&c.)} + \&c. = 0,$$

which is (3') or the index-surface, proving the theorem in question.

It is evident that the circles of contact on the wave correspond in this process to the conical cusps; and indeed (6) cannot pass through a cusp unless (substituting in (6) the coordinates of the cusp)

$$\frac{c^2}{bc} \frac{a^2 - b^2}{a^2 - c^2} + \frac{a^2}{ab} \frac{b^2 - c^2}{a^2 - c^2} = 1,$$

or 
$$(b - a)(b - c) = 0,$$

which can happen only in uncrystallized bodies or uniaxal crystals.

The transformation (3) shows at once that *the index-surface may be changed into the wave by a process of linear deformation (i.e. of compression or extension in different degrees parallel to the three axes), that in fact by which the ellipsoid*

$$bcx^2 + cay^2 + abz^2 = 1 \dots\dots\dots(8)$$

is changed to 
$$\frac{x^2}{bc} + \frac{y^2}{ca} + \frac{z^2}{ab} = 1 \dots\dots\dots(6),$$

namely, by putting  $x/bc$  for  $x$ , &c.

Hence it is evident that *the index-surface is its own reciprocal with respect to the ellipsoid (8).*

The above is only one of a host of easily assignable transformations of (1).

Queen's College, Belfast, May 27th, 1859.

### III.

## QUATERNION INVESTIGATIONS CONNECTED WITH ELECTRO-DYNAMICS AND MAGNETISM.

[*Quarterly Journal of Mathematics, January, 1860.*]

1. THE following pages are intended to show, in the particular cases of the mutual action of galvanic currents, and of the forces exerted by permanent magnets on each other, the superiority of the Calculus of Quaternions over the ordinary analytical processes of Geometry of Three Dimensions. I have followed therefore very closely the method already employed for the action of currents, based as it is on the seemingly legitimate assumption that the action between two elements of currents is in the line joining them.

I intend to give, on another occasion, some more general quaternion investigations, in which no such assumption is made.

A comparison between the processes employed in this paper and those of Ampère (*Théorie des Phénomènes Électrodynamiques, &c.*, many of which are well given by Murphy in his *Electricity*) will at once show how much is gained in simplicity and directness by the use of Quaternions.

The same gain in simplicity will be noticed in the investigations of the mutual effects of permanent magnets, where the resultant forces and couples are at once introduced in their most natural and direct forms.

Somewhat of the conciseness of the method is lost by the necessity of going out of the way to prove results in Quaternions, a step which would not be requisite if the Calculus were more generally known.



2. Ampère's experimental laws may be stated as follows:

I. Equal and opposite currents in the same conductor produce equal and opposite effects on other conductors, whence it follows that an element of one current has no effect on an element of another which lies in the plane bisecting the former at right angles.

II. The effect of a conductor bent or twisted in any manner is equivalent to that of a straight one, provided that the two are traversed by equal currents, and the former *nearly* coincides with the latter.

III. No closed circuit can set in motion an element of a circular conductor about an axis through the centre of the circle and perpendicular to its plane.

IV. In similar systems traversed by equal currents the forces are equal.

To these we add the assumption already referred to (1), and two others, viz. that the effect of any element of a current on another is directly as the product of the quantities of the currents, and of the lengths of the elements.

3. Let there be two closed currents whose *quantities* are  $a$  and  $a_1$ ; let  $\alpha'$ ,  $\alpha_1$  be elements of these,  $\alpha$  being the vector joining their middle points. Then the effect of  $\alpha'$  on  $\alpha_1$  must, when resolved along  $\alpha_1$ , be a complete differential with respect to  $\alpha$  (*i.e.* with respect to the three independent variables involved in  $\alpha$ ), since the total resolved effect of the closed circuit of which  $\alpha'$  is an element is zero by III.

Also by I, II, the effect is a function of  $T\alpha$ ,  $S\alpha\alpha'$ ,  $S\alpha\alpha_1$ , and  $S\alpha'\alpha_1$ , since these are sufficient to resolve  $\alpha'$  and  $\alpha_1$  into elements parallel and perpendicular to each other and to  $\alpha$ . Hence the mutual effect

$$= aa_1 U\alpha f(T\alpha, S\alpha\alpha', S\alpha\alpha_1, S\alpha'\alpha_1),$$

and resolved effect

$$= aa_1 f' S U\alpha_1 U\alpha.$$

Also, that action and reaction may be equal in absolute magnitude,  $f$  must be symmetrical in  $S\alpha\alpha'$  and  $S\alpha\alpha_1$ . Again  $\alpha'$  (as differential of  $\alpha$ ) can enter *only to the first power*, and *must* appear in each term of  $f$ .

Hence

$$f = AS\alpha'\alpha_1 + BS\alpha\alpha'S\alpha\alpha_1.$$

But, by IV, this must be independent of the dimensions of the system. Hence  $A$  is of  $-2$  and  $B$  of  $-4$  dimensions in  $T\alpha$ . Under these circumstances,

$$\frac{1}{T\alpha} \{AS\alpha\alpha_1 S\alpha'\alpha_1 + BS\alpha\alpha'(S\alpha\alpha_1)^2\}$$

is to be a complete differential, with respect to  $\alpha$ , if  $d\alpha = \alpha'$ . Let  $A = C/T\alpha^2$ , where  $C$  is a constant depending on the units employed. Then

$$d\left(\frac{C}{2T\alpha^2}\right) = \frac{B}{T\alpha} S\alpha\alpha',$$

or

$$B = \frac{3}{2} \frac{C}{T\alpha^4},$$

and the resolved effect

$$\begin{aligned} &= \frac{Caa_1}{2T\alpha_1} d \left\{ \frac{(S\alpha\alpha_1)^2}{T\alpha^3} \right\} = Caa_1 \frac{S\alpha\alpha_1}{T\alpha_1 T\alpha^3} (-\alpha^2 S\alpha'\alpha_1 + \frac{3}{2} S\alpha\alpha' S\alpha\alpha_1) \\ &= Caa_1 \frac{S\alpha\alpha_1}{T\alpha_1 T\alpha^3} (S \cdot V\alpha\alpha' V\alpha\alpha_1 + \frac{1}{2} S\alpha\alpha' S\alpha\alpha_1). \end{aligned}$$

The factor in brackets is evidently proportional in the ordinary notation to

$$(\sin \theta \sin \theta' \cos \omega - \frac{1}{2} \cos \theta \cos \theta').$$

4. Thus the whole force is

$$\frac{Caa_1\alpha}{2S\alpha\alpha_1} d \left\{ \frac{(S\alpha\alpha_1)^2}{T\alpha^3} \right\} = \frac{Caa_1\alpha}{2S\alpha\alpha'} d_1 \left\{ \frac{(S\alpha\alpha')^2}{T\alpha^3} \right\},$$

as we should expect,  $d_1\alpha$  being  $=\alpha_1$ . (This may easily be transformed into

$$-\frac{2Caa_1 U\alpha}{(T\alpha)^{\frac{1}{2}}} dd_1 (T\alpha)^{\frac{1}{2}},$$

which is the Quaternion expression for Ampère's well-known form.)

5. The whole effect on  $\alpha_1$  of the closed circuit, of which  $\alpha'$  is an element, is therefore

$$\begin{aligned} &\frac{Caa_1}{2} \int \frac{\alpha}{S\alpha\alpha_1} d \left\{ \frac{(S\alpha\alpha_1)^2}{T\alpha^3} \right\} \\ &= \frac{Caa_1}{2} \left\{ \frac{\alpha S\alpha\alpha_1}{T\alpha^3} - V \cdot \alpha_1 \int \frac{V\alpha\alpha'}{T\alpha^3} \right\} \end{aligned}$$

between proper limits. As the integrated part is the same at both limits, the effect is

$$-\frac{Caa_1}{2} V\alpha_1\beta, \text{ where } \beta = \int \frac{V\alpha\alpha'}{T\alpha^3} = \int \frac{dU\alpha}{\alpha},$$

and depends on the form of the closed circuit.

5'. This vector  $\beta$ , which is of great importance in the whole theory of the effects of closed or indefinitely extended circuits, corresponds to the line which is called by Ampère "*directrice de l'action électrodynamique*." It has a definite value at each point of space, independent of the existence of any other current.

Consider the circuit a polygon whose sides are indefinitely small; join its angular points with any assumed point, erect at the latter, perpendicular to the plane of each elementary triangle so formed, a vector whose length is  $\omega/r$ , where  $\omega$  is the vertical angle of the triangle and  $r$  the length of one of the containing sides; the sum of such vectors is the "*directrice*" at the assumed point.

6. The *form* of the result of (5) shows at once that *if the element  $\alpha_1$  be turned about its middle point, the direction of the resultant action is confined to the plane whose normal is  $\beta$ .*

Suppose that the element  $\alpha_1$  is forced to remain perpendicular to some given vector  $\delta$ , we have

$$S\alpha_1\delta = 0,$$

and the whole action in its plane of motion is proportional to  $T'V \cdot \delta V\alpha_1\beta$ .

But 
$$V \cdot \delta V\alpha_1\beta = -\alpha_1 S\beta\delta.$$

Hence the action is evidently constant for all possible positions of  $\alpha_1$ ; or

*The effect of any system of closed currents on an element of a conductor which is restricted to a given plane is (in that plane) independent of the direction of the element.* [The force-component in the plane is  $\delta^{-1}V \cdot \delta V\alpha_1\beta = -\delta^{-1}\alpha_1 S\beta\delta$ . 1897.]

7. Let the closed current be *plane* and *very small*. Let  $\epsilon$  (where  $T\epsilon = 1$ ) be its normal, and let  $\gamma$  be the vector of any point within it (as the centre of gravity of its area); the middle point of  $\alpha_1$  being the origin of vectors.

Let 
$$\alpha = \gamma + \rho; \text{ therefore } \alpha' = \rho',$$

and

$$\begin{aligned} \beta &= \int \frac{V\alpha\alpha'}{T\alpha^3} = \int \frac{V(\gamma + \rho)\rho'}{T(\gamma + \rho)^3} \\ &= \frac{1}{T\gamma^3} \int V(\gamma + \rho)\rho' \left\{ 1 + \frac{3S\gamma\rho}{T\gamma^2} \right\} \end{aligned}$$

to a sufficient approximation.

Now (between limits) 
$$\int V\rho\rho' = 2A\epsilon,$$

where  $A$  is the area of the closed circuit.

Also generally (see Art. (13))

$$\begin{aligned} \int V\gamma\rho'S\gamma\rho &= \frac{1}{2}(S\gamma\rho V\gamma\rho + \gamma V\gamma \int V\rho\rho') \\ &= (\text{between limits}) A\gamma V\gamma\epsilon. \end{aligned}$$

Hence for this case

$$\begin{aligned} \beta &= \frac{A}{T\gamma^3} \left( 2\epsilon + \frac{3\gamma V\gamma\epsilon}{T\gamma^2} \right) \\ &= -\frac{A}{T\gamma^3} \left( \epsilon + \frac{3\gamma S\gamma\epsilon}{T\gamma^2} \right). \end{aligned}$$

8. If, instead of one small plane closed current, there be a series of such, of equal area, disposed regularly in a tubular form, let  $x$  be the distance between two consecutive currents measured along the axis of the tube; then, putting  $\gamma' = x\epsilon$ , we have for the whole effect of such a set of currents on  $\alpha_1$

$$\begin{aligned} &\frac{CAaa_1}{2x} V\alpha_1 \int \left( \frac{\gamma'}{T\gamma^3} + \frac{3\gamma S\gamma\gamma'}{T\gamma^5} \right) \\ &= \frac{CAaa_1}{2x} \frac{V\alpha_1\gamma}{T\gamma^3} \quad (\text{between proper limits}). \end{aligned}$$

If the axis of the tubular arrangement be a closed curve this will evidently vanish. Hence a closed solenoid exerts no influence on an element of a conductor. The same is evidently true if the solenoid be indefinite in both directions.

If the axis extend to infinity in one direction, and  $\gamma_0$  be the vector of the other extremity, the effect

$$= \frac{CAaa_1}{2x} \frac{V\alpha_1\gamma_0}{T\gamma_0^3},$$

and is therefore perpendicular to the element and to the line joining it with the extremity of the solenoid. It is evidently inversely as  $T\gamma_0^2$  and directly as the sine of the angle contained between the direction of the element and that of the line joining the latter with the extremity of the solenoid. It is also inversely as  $x$ , and therefore directly as the number of currents in unit of the axis of the solenoid.

9. To find the effect of the whole circuit, whose element is  $\alpha_1$ , on the extremity of the solenoid, we must change the sign of the above and put  $\alpha_1 = \gamma_0'$ ; therefore

$$\text{effect} = -\frac{CAaa_1}{2x} \int \frac{V\gamma_0'\gamma_0}{T\gamma_0^3},$$

an integral of the species considered in (5'), whose value is easily assigned in particular cases.

10. Suppose the conductor to be straight, and indefinitely extended in both directions.

Let  $h\zeta$  be the vector perpendicular to it from the extremity of the solenoid, and let the conductor be  $\parallel\eta$ , where  $T\zeta = T\eta = 1$ .

Therefore  $\gamma_0 = h\zeta + y\eta$  (where  $y$  is a scalar),

$$V\gamma_0'\gamma_0 = hy'V\eta\zeta,$$

and the integral in (9) is  $hV\eta\zeta \int_{-\infty}^{+\infty} \frac{y'}{(h^2 + y^2)^{\frac{3}{2}}} = \frac{2}{h} V\eta\zeta$ .

The whole effect is therefore  $-\frac{CAaa_1}{xh} V\eta\zeta$ ,

and is thus perpendicular to the plane passing through the conductor and the extremity of the solenoid, and varies inversely as the distance of the latter from the conductor.

This is exactly the observed effect of an indefinite straight conductor on a magnetic pole, or particle of free magnetism.

11. Suppose the conductor to be circular, and the pole nearly in its axis. [This is not a proper subject for Quaternions. 1890.]

Let  $EPD$  (fig. 1) be the conductor,  $AB$  its axis, and  $C$  the pole;  $BC$  perpendicular to  $AB$ , and small in comparison with  $AE = h$  the radius of the circle.

Let

$$AB \text{ be } c_1 i, \quad BC = bk, \quad AP = h(jx + ky)$$

where

$$\begin{pmatrix} x \\ y \end{pmatrix} = \begin{pmatrix} \cos \\ \sin \end{pmatrix} \widehat{EAP} = \begin{pmatrix} \cos \\ \sin \end{pmatrix} \theta.$$

Then

$$CP = \gamma = c_1 i + bk - h(jx + ky).$$

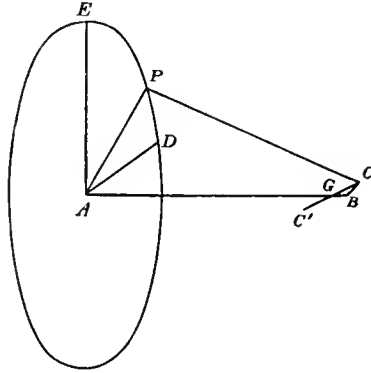

Fig. 1.

And the effect on  $C \propto \int \frac{V\gamma\gamma'}{T\gamma^3},$

$$\propto h \int \frac{\theta' \{(h - by) i + c_1 x j + c_1 y k\}}{(c_1^2 + b^2 + h^2 - 2bhy)^{\frac{3}{2}}},$$

where the integral extends to the whole circuit.

11'. Suppose in particular  $C$  to be one pole of a small magnet or solenoid  $CC'$  whose length is  $2l$ , and whose middle point is at  $G$  and distant  $c$  from the centre of the conductor. Let  $\widehat{CGB} = \Delta$ . Then evidently

$$c_1 = c + l \cos \Delta,$$

$$b = l \sin \Delta.$$

Also the effect on  $C$  becomes, if  $c_1^2 + b^2 + h^2 = A^2$ ,

$$\begin{aligned} \frac{h}{A^3} \int \theta' \{(h - by) i + c_1 x j + c_1 y k\} \left\{ 1 + \frac{3bhy}{A^2} + \frac{15}{2} \frac{h^2 b^2 y^2}{A^4} + \dots \right\} \\ = \frac{\pi h^2}{A^3} \left( 2i - \frac{3b^2 i}{A^2} + \frac{3c_1 bk}{A^2} + \frac{15}{2} \frac{h^2 b^2 i}{A^4} + \dots \right), \end{aligned}$$

since for the whole circuit

$$\int \theta' y^{2n} = 2\pi \frac{2n!}{2^{2n} (n!)^2},$$

$$\int \theta' y^{2n+1} = 0,$$

$$\int \theta' xy^m = 0.$$

If we suppose the centre of the magnet fixed, the vector axis of the couple produced by the action of the current on  $C$  is

$$lV(i \cos \Delta + k \sin \Delta) \int \frac{V\gamma\gamma'}{T\gamma^3} \\ \propto \frac{\pi h^2 l \sin \Delta}{A^3} j \left\{ 2 - \frac{3b^2}{A^2} + \frac{15 h^2 b^2}{2 A^4} - \frac{3c_1 b \cos \Delta}{A^2 \sin \Delta} \right\}.$$

If  $A$ , &c. be now developed in powers of  $l$ , this at once becomes

$$\frac{\pi h^2 l \sin \Delta}{(c^2 + h^2)^{\frac{3}{2}}} j \left\{ 2 - \frac{6cl \cos \Delta}{c^2 + h^2} + \frac{15c^2 l^2 \cos^2 \Delta}{(c^2 + h^2)^2} - \frac{3l^2}{c^2 + h^2} \right. \\ \left. - \frac{3l^2 \sin^2 \Delta}{c^2 + h^2} + \frac{15 h^2 l^2 \sin^2 \Delta}{2 (c^2 + h^2)^2} - 3 \frac{(c + l \cos \Delta) l \cos \Delta}{c^2 + h^2} \left( 1 - \frac{5cl \cos \Delta}{c^2 + h^2} \right) \right\}.$$

Putting  $-l$  for  $l$  and changing the sign of the whole to get that for pole  $C'$ ; we have for the vector axis of the complete couple

$$\frac{4\pi h^2 l \sin \Delta}{(c^2 + h^2)^{\frac{3}{2}}} j \left\{ 1 + \frac{3 l^2 (4c^2 - h^2) (4 - 5 \sin^2 \Delta)}{4 (c^2 + h^2)^2} + \&c. \right\},$$

which is almost exactly proportional to  $\sin \Delta$  if  $2c = h$  and  $l$  be small.

On this depends Gaugain's modification of the tangent galvanometer. (Bravais—*Ann. de Chimie*, xxxviii. 309.)

12. As before, the effect of an indefinite solenoid on  $\alpha_1$  is

$$\frac{CAaa_1}{2x} \cdot \frac{V\alpha_1\gamma}{T\gamma^3}.$$

Now suppose  $\alpha_1$  to be an element of a small plane circuit,  $\delta$  the vector of the centre of gravity of its area, the pole of the solenoid being origin.

Let  $\gamma = \delta + \rho$ , then  $\alpha_1 = \rho'$ .

$$\text{Whole effect therefore} = - \frac{CAaa_1}{2x} \int \frac{V \cdot (\delta + \rho) \rho'}{T(\delta + \rho)^3} \\ = \frac{CA A_1 aa_1}{2x T \delta^3} \left( \epsilon_1 + \frac{3\delta S \delta \epsilon_1}{T \delta^2} \right),$$

where  $A_1$  and  $\epsilon_1$  are for the new circuit, what  $A$  and  $\epsilon$  were for the former (7).

Let the new circuit also belong to an indefinite solenoid, and let  $\delta_0$  be the vector joining the poles of the two solenoids. Then the mutual effect is

$$\frac{CA A_1 aa_1}{2x x_1} \int \left( \frac{\delta}{T \delta^3} + \frac{3\delta S \delta \delta'}{T \delta^5} \right) \\ = \frac{CA A_1 aa_1}{2x x_1} \cdot \frac{\delta_0}{(T \delta_0)^3} \propto \frac{U \delta_0}{(T \delta_0)^2},$$

which is exactly the mutual effect of two magnetic poles. Two finite solenoids then act on each other exactly as two magnets, and the pole of an indefinite solenoid acts as a particle of free magnetism.

13. The mutual attraction of two indefinitely small plane closed circuits, whose normals are  $\epsilon$  and  $\epsilon_1$ , may evidently be deduced by twice differentiating the expression  $\frac{U\delta}{T\delta^3}$  for the mutual action of the poles of two indefinite solenoids, making  $d\delta$  in one differentiation  $\parallel \epsilon$  and in the other  $\parallel \epsilon_1$ .

But it may otherwise be calculated directly by a process which will also give us the couple impressed on one of the circuits by the other, supposing for simplicity the first to be *circular*.

In fig. 2 let  $A$  and  $B$  be the centres of gravity of the areas of  $A$  and  $B$ ,  $\epsilon$  and  $\epsilon_1$  vectors normal to their planes,  $\sigma$  any vector radius of  $B$ ,  $AB = \beta$ .

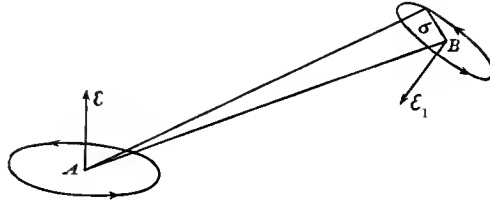

Fig. 2.

Then whole effect on  $\sigma'$ , by (7),

$$\propto \frac{A}{T(\beta + \sigma)^3} V \cdot \sigma' \left\{ \epsilon + \frac{3(\beta + \sigma)S(\beta + \sigma)\epsilon}{T(\beta + \sigma)^2} \right\},$$

$$\propto \frac{1}{T\beta^3} \left\{ V\sigma'\epsilon \left( 1 + \frac{3S\beta\sigma}{T\beta^2} \right) + \frac{3V\sigma'\beta S\beta\epsilon}{T\beta^2} \left( 1 + \frac{5S\beta\sigma}{T\beta^2} \right) + \frac{3V\sigma'\beta S\sigma\epsilon}{T\beta^2} + 3 \frac{V\sigma'\sigma S\beta\epsilon}{T\beta^2} \right\}.$$

But, between proper limits, ( $\theta$  being *now* any constant vector)

$$\int V\sigma'\eta S\theta\sigma = -A_1 V \cdot \eta V\theta\epsilon_1,$$

for generally

$$\int V\sigma'\eta S\theta\sigma = -\frac{1}{2}(V\eta\sigma S\theta\sigma + V \cdot \eta V \cdot \theta \int V\sigma\sigma').$$

Hence after a reduction or two we find the whole force exerted by  $A$  on the centre of gravity of the area of  $B$ ,

$$\propto \frac{AA_1}{T\beta^3} \left\{ \beta \left( S\epsilon\epsilon_1 + \frac{5S\beta\epsilon S\beta\epsilon_1}{T\beta^2} \right) + \epsilon S\beta\epsilon_1 + \epsilon_1 S\beta\epsilon \right\}.$$

This, as already observed, may be at once found by twice differentiating  $U\beta/T\beta^2$ . In the same way the vector moment due to  $A$ , about the centre of gravity of  $B$ ,

$$\propto \frac{A}{T\beta^3} \int V \cdot \sigma \left( V\sigma'\epsilon + \frac{3V\sigma'\beta S\beta\epsilon}{T\beta^2} \right),$$

$$\propto -\frac{AA_1}{T\beta^3} \left( V\epsilon\epsilon_1 + \frac{3V\beta\epsilon_1 S\beta\epsilon}{T\beta^2} \right).$$

These expressions for the whole force of one small magnet on the centre of gravity of another, and the couple about the latter, seem to be the simplest that can be given. It is easy to deduce from them the ordinary forms. For instance, the whole resultant couple on the second magnet

$$\propto \frac{T \left( V\epsilon\epsilon_1 + \frac{3V\beta\epsilon_1 S\beta\epsilon}{T\beta^2} \right)}{T\beta^3},$$

may easily be shown to coincide with that given by Ellis (*Cumb. Math. Journal*, iv. 95), though it seems to lose in simplicity and capability of interpretation by such modifications.

13'. The above formulæ show that the whole force exerted by one small magnet  $M$  on the centre of gravity of another  $m$ , consists of four terms which are in order,

1st. *In the line joining the magnets and proportional to the cosine of their mutual inclination.*

2nd. *In the same line and proportional to five times the product of the cosines of their respective inclinations to this line.*

3rd and 4th. *Parallel to  $\left\{ \begin{smallmatrix} m \\ M \end{smallmatrix} \right\}$  and proportional to the cosine of the inclination of  $\left\{ \begin{smallmatrix} M \\ m \end{smallmatrix} \right\}$  to the joining line.*

All these forces are in addition inversely as the fourth power of the distance between the magnets.

For the couples about the centre of gravity of  $m$  we have—

1st. *A couple whose axis is perpendicular to each magnet and which is as the sine of their mutual inclination.*

2nd. *A couple whose axis is perpendicular to  $m$  and to the line joining the magnets, and whose moment is as three times the product of the sine of the inclination of  $m$ , and the cosine of the inclination of  $M$ , to the joining line.*

In addition these couples vary inversely as the third power of the distance between the magnets.

These results afford a good example of what has been called the *internal* nature of the methods and results of Quaternions, reducing as they do at once the forces and couples to others independent of any lines of reference, other than those necessarily belonging to the system under consideration.

To show their ready applicability, I take a Theorem due to Gauss.

*If two small magnets be at right angles to each other, the moment of rotation of the first is approximately twice as great when the axis of the second passes through the centre of the first, as when the axis of the first passes through the centre of the second.*



In the first case

$$\epsilon \parallel \beta + \epsilon_1;$$

therefore moment

$$= \frac{C'}{T\beta^3} T(\epsilon\epsilon_1 - 3\epsilon\epsilon_1) = \frac{2C'}{T\beta^3} T\epsilon\epsilon_1.$$

In the second

$$\epsilon_1 \parallel \beta + \epsilon;$$

therefore moment

$$= \frac{C'}{T\beta^3} T\epsilon\epsilon_1. \text{ Hence the theorem.}$$

14. Again we may easily reproduce the results of (13), if for the two small circuits we suppose two small magnets perpendicular to their planes to be substituted.  $\beta$  is then the vector joining the middle points of these magnets, and by changing the tensors we may take  $2\epsilon$  and  $2\epsilon_1$  as the vector lengths of the magnets.

Hence evidently the mutual effect

$$\propto \frac{U}{T^2} (\beta + \epsilon - \epsilon_1) - \frac{U}{T^2} (\beta - \epsilon - \epsilon_1) + \frac{U}{T^2} (\beta - \epsilon + \epsilon_1) - \frac{U}{T^2} (\beta + \epsilon + \epsilon_1),$$

which is easily reducible to

$$- \frac{12}{T\beta^5} \left\{ \beta \left( S\epsilon\epsilon_1 + \frac{5S\beta\epsilon S\beta\epsilon_1}{T\beta^2} \right) + \epsilon_1 S\beta\epsilon + \epsilon S\beta\epsilon_1 \right\} \text{ as before,}$$

if smaller terms be omitted.

If we operate with  $V.\epsilon_1$  on the two first terms of the unreduced expression, and take the difference between the result and the same with the sign of  $\epsilon_1$  changed, we have the whole vector axis of the couple on the magnet  $2\epsilon_1$ .

$$\propto \frac{4}{T\beta^3} \left( V\epsilon_1\epsilon + \frac{3V\epsilon_1\beta S\beta\epsilon}{T\beta^2} \right) \text{ as before.}$$

15. A theorem which Ampère used for a time as one of his fundamental experiments, is—*A circular conductor cannot set in rotation about its axis another conductor of any form whose extremities are in that axis.*

Let  $\alpha_1$  be an element of the circular conductor,

$\alpha'$  ..... other .....

By (5) the whole force on  $\alpha_1$  is

$$\eta \propto \frac{\alpha S\alpha\alpha_1}{T\alpha^3} - V.\alpha_1 \int \frac{V\alpha\alpha'}{T\alpha^3}$$

between proper limits. And whole moment, about axis, of force on  $\alpha_1 \propto S\alpha_1\eta$ ,

$$\propto \frac{(S\alpha\alpha_1)^2}{T\alpha^3} \text{ between limits.}$$

But at the extremities  $S\alpha\alpha_1 = 0$ , since they lie in the axis. Hence there is no force tending to rotate the element  $\alpha_1$  about the axis, and consequently  $\alpha_1$  exerts none to turn the moveable conductor.

16. We might apply the foregoing formulæ with great ease to other cases treated by Ampère, De Montferand, &c.—or to two finite circular conductors as in Weber's Dynamometer—but in general the only difficulty is in the integration, which even in some of the simplest cases involves Elliptic Integrals, &c., &c.

17. Quaternions give a simple method of deducing the well-known property of the *magnetic curves*.

Let  $A, A'$  (fig. 3) be two magnetic poles, whose vector distance  $= 2\alpha$  is bisected in  $O, QQ'$  an indefinitely small magnet whose length is  $2\rho'$ , where  $\rho = OP$ . Then evidently, taking moments,

$$\frac{V(\rho + \alpha)\rho'}{T(\rho + \alpha)^3} = \pm \frac{V(\rho - \alpha)\rho'}{T(\rho - \alpha)^3}.$$

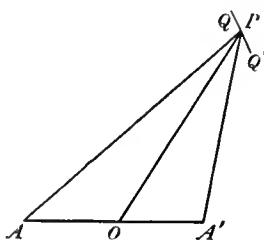

Fig. 3.

Operate by  $S.V\alpha\rho$ ,

$$\frac{S\alpha\rho'(\rho + \alpha)^2 - S\alpha(\rho + \alpha)S\rho'(\rho + \alpha)}{T(\rho + \alpha)^3} = \pm \{\text{same with } -\alpha\},$$

or 
$$S.\alpha V\left(\frac{\rho'}{\rho + \alpha}\right)U(\rho + \alpha) = \pm \{\text{same with } -\alpha\},$$

i.e. 
$$S.adU(\rho + \alpha) = \pm S.adU(\rho - \alpha),$$

$$S.\alpha\{U(\rho + \alpha) \pm U(\rho - \alpha)\} = \text{const.},$$

or 
$$\cos \widehat{OAP} \pm \cos \widehat{OA'P} = \text{const.},$$

the property referred to.

*Queen's College, Belfast, October 31st, 1859.*

### IV.

#### QUATERNION INVESTIGATION OF THE POTENTIAL OF A CLOSED CIRCUIT.

[*Quarterly Journal of Mathematics, Oct. 1860.*]

LET  $F(\gamma)$  be the potential of any system upon a unit particle at the extremity of  $\gamma$ .

$$F(\gamma) = C \dots\dots\dots(1)$$

is the equation of a level surface.

Let the differential of (1) be

$$S \cdot \nu d\gamma = 0 \dots\dots\dots(2),$$

then  $\nu$  is a vector normal to (1), and is therefore the *direction* of the force.

But, passing to a proximate level surface, we have

$$S \cdot \nu \delta\gamma = \delta C.$$

Make  $\delta\gamma = x\nu$ , then

$$- xTv^2 = \delta C,$$

or

$$- Tv = \frac{\delta C}{T\delta\gamma}.$$

Hence  $\nu$  expresses the force in *magnitude* also.

Now by Art. 7 of my Paper on *Quaternion Investigations connected with Electrodynamics* (p. 25 above), we have for the vector force exerted by a small plane closed circuit on a particle of free magnetism the expression

$$- \frac{A}{T\gamma^3} \left( \epsilon + \frac{3\gamma S\gamma\epsilon}{T\gamma^2} \right),$$

omitting the factors depending on the quantity of the current and the strength of magnetism of the particle.

Hence the potential, by (2) and (1),

$$\begin{aligned} &\propto A \int \frac{1}{T\gamma^3} \left( S\epsilon d\gamma + \frac{3S\gamma d\gamma S\gamma\epsilon}{T\gamma^2} \right), \\ &\propto \frac{AS\epsilon\gamma}{T\gamma^3}, \\ &\propto \frac{\text{area of circuit projected perpendicular to } \gamma}{T\gamma^2}, \\ &\propto \text{solid angle subtended by circuit.} \end{aligned}$$

The constant is omitted in the integration as the potential must evidently vanish for infinite values of  $T\gamma$ .

By means of Ampère's idea of breaking up a finite circuit into an indefinite number of indefinitely small ones, it is evident that the above result may be at once extended to the case of such a finite closed circuit.

*Queen's College, Belfast, February 22, 1860.*

## V.

NOTE ON A MODIFICATION OF THE APPARATUS EMPLOYED  
FOR ONE OF AMPÈRE'S FUNDAMENTAL EXPERIMENTS IN  
ELECTRODYNAMICS.

[*Proceedings of the Royal Society of Edinburgh, Feb. 18, 1861.*]

My attention was recalled by Principal Forbes's note (read to the Royal Society on January 7th), to his request that I should at leisure try to repeat Ampère's experiment for the mutual repulsion of two parts of the same straight conductor, by means of an apparatus which he had procured for the Natural Philosophy Collection in the University. Some days later I tried the experiment, but found that, on account of the narrowness of the troughs of mercury, it was impossible to prevent the capillary forces from driving the floating wire to the sides of the vessel. I therefore constructed an apparatus in which the troughs were two inches wide, the arms of the float being also at that distance apart. Making the experiment according to Ampère's method with this arrangement, I found one small Grove's cell sufficient to produce a steady motion of the float from the poles of the pile; in fact, the only difficulty in repeating the experiment lies in obtaining a perfectly clean mercurial surface.

Two objections have been raised against Ampère's interpretation of this experiment, one of which is intimately connected with the subject of Principal Forbes's note. This is the difficulty of ascertaining exactly what takes place where a voltaic current passes from one conducting body to another of different material. It is known that thermal and thermo-electric effects generally accompany such a passage. To get rid of this source of uncertainty, I have repeated Ampère's experiment in a form which excludes it entirely. In this form of the experiment the polar conductors and the float form one continuous metallic mass with the mercury in the troughs; the float being formed

of glass tube filled with mercury, with its extremities slightly curved downwards so as to dip all but entirely under the surface of the fluid; and the wires from the battery being plunged into the upturned outward extremities of two glass tubes, which are pushed through the ends of the troughs so as to project an inch or two inwards under the surface of the mercury. A little practice is requisite to success in filling the float and immersing it in the troughs without admitting a bubble of air. This float, being heavier than the ordinary copper wire, plunges deeper in the fluid, and encounters more resistance to its motion, but, with two small Grove's cells only, Ampère's result was easily reproduced, even when the extremities of the float rested in contact with those of the polar tubes before the circuit was completed. It is obvious that here no thermo-electric effects can be produced in the mercury, and I have satisfied myself that the motion commences before the passage of the current can have sensibly heated the fluid in the tubes.

The other class of objections to Ampère's conclusion from this experiment, depending on the spreading of the current in the mercury of the troughs, is of course not met by this modification. I have made several experiments with a view to obviate this also, but my time has been so much occupied that I have not been able as yet to put them in a form suitable for communication to this Society.

## VI.

## FORMULÆ CONNECTED WITH SMALL CONTINUOUS DISPLACEMENTS OF THE PARTICLES OF A MEDIUM.

[*Proceedings of the Royal Society of Edinburgh, April 4, 1862.*]

ALTHOUGH most of the results deduced in this Note have been long known, I venture to offer it to the Society on account of the extreme simplicity of the analysis employed, and the consequent insight it affords us into the connection of various formulæ. I intend on a future occasion to give large further developments especially bearing on physics. I employ the calculus of quaternions throughout, but where some unusual expressions occur, I have given them in their common Cartesian form, as well as in the quaternion one.

1. If  $F\rho = C$ .....(1)

be the equation of one of a system of surfaces, and if the differential of (1) be

$$S. \nu d\rho = 0$$
.....(2),

$\nu$  is a vector perpendicular to the surface, and its length is inversely proportional to the normal distance between two consecutive surfaces. In fact (2) shows that  $\nu$  is perpendicular to  $d\rho$ , which is any tangent vector, thus proving the first assertion. Also, since in passing to a proximate surface we may write

$$S. \nu \delta\rho = \delta C,$$

we see that

$$F(\rho + \nu^{-1} \delta C) = C + \delta C.$$

This proves the latter assertion.

It is evident from the above that if (1) be an equipotential, or an isothermal,

surface,  $-\nu$  represents in direction and magnitude the force at any point, or the vector-gradient of temperature. And we see at once that if

$$\nabla = i \frac{d}{dx} + j \frac{d}{dy} + k \frac{d}{dz} \dots\dots\dots(3),$$

giving

$$\nabla^2 = -\frac{d^2}{dx^2} - \frac{d^2}{dy^2} - \frac{d^2}{dz^2} \dots\dots\dots(3)^1,$$

then

$$\nu = \nabla F\rho \dots\dots\dots(4).$$

This is due to Sir W. R. Hamilton (*Lectures on Quaternions*, p. 611).

From this it follows that *the effect of the vector operator  $\nabla$ , upon any scalar function of the vector of a point, is to produce the vector which represents in magnitude and direction the most rapid change in the value of the function.*

Let us next consider the effect of  $\nabla$  upon a *vector* as

$$\sigma = i\xi + j\eta + k\zeta \dots\dots\dots(5).$$

We have at once

$$\nabla\sigma = -\left(\frac{d\xi}{dx} + \frac{d\eta}{dy} + \frac{d\zeta}{dz}\right) - i\left(\frac{d\eta}{dz} - \frac{d\zeta}{dy}\right) - \&c. \dots\dots\dots(6),$$

and in this semi-Cartesian form it is easy to see that—

*If  $\sigma$  represent a small vector displacement of a point situated at the extremity of the vector  $\rho$  (drawn from the origin)*

*$S.\nabla\sigma$  represents the consequent cubical compression of the group of points in the vicinity of that considered, and*

*$V.\nabla\sigma$  represents twice the vector axis of rotation of the same group of points.*

Similarly

$$S.\sigma\nabla = -\left(\xi \frac{d}{dx} + \eta \frac{d}{dy} + \zeta \frac{d}{dz}\right) = -D_\sigma \dots\dots\dots(7),$$

*or is equivalent to total differentiation in virtue of our having passed from one end to the other of the vector  $\sigma$ .*

The interpretation of  $V.\sigma\nabla$  is also easy enough, but it is not required for the present investigation.

2. Suppose we fix our attention upon a group of points which originally filled a small sphere about the extremity of  $\rho$  as centre, whose equation referred to that point is

$$T\omega = e \dots\dots\dots(8).$$

After displacement  $\rho$  becomes  $\rho + \sigma$ , and by (7)  $\rho + \omega$  becomes  $\rho + \omega + \sigma - (S.\omega\nabla)\sigma$ . Hence the vector of the new surface which encloses the group of points (drawn from the extremity of  $\rho + \sigma$ ), is

$$\omega_1 = \omega - (S.\omega\nabla)\sigma \dots\dots\dots(9).$$



Hence  $\omega$  is a homogeneous linear and vector function of  $\omega_1$ ; or

$$\omega = \phi \omega_1$$

in Sir W. R. Hamilton's notation, and therefore by (8)

$$T\phi\omega_1 = e \dots \dots \dots (10),$$

the equation of the new surface, which is evidently a central surface of the second order, and therefore, of course, an ellipsoid (Cauchy—*Exercises*, vol. II.).

We may solve (9) with great ease by approximation, if we remember that  $T\sigma$  is very small, and therefore that in the small term we may put  $\omega_1$  for  $\omega$ —i.e. omit squares of small quantities; thus,

$$\omega = \omega_1 + (S.\omega_1\nabla)\sigma \dots \dots \dots (11).$$

Or if we choose we may obtain the exact solution very easily. Operating on (9) with  $S.i, S.j, S.k$ , we get

$$Si\omega_1 = S\omega (i + \nabla\xi), \text{ \&c.} = \text{\&c.}$$

$$\text{Hence } \omega S.(i + \nabla\xi)(j + \nabla\eta)(k + \nabla\zeta) = V.(j + \nabla\eta)(k + \nabla\zeta)Si\omega_1 + \text{\&c.}$$

From this we may easily verify the former expression by omitting products of  $\xi, \eta, \zeta$ .

$$\text{Thus } \omega(-1-h) = \left[ i(1+h) - \frac{d\sigma}{dx} \right] Si\omega_1 + \text{\&c.} + \text{\&c.},$$

$$\text{where } h = \frac{d\xi}{dx} + \frac{d\eta}{dy} + \frac{d\zeta}{dz}.$$

$$\begin{aligned} \text{Or } \omega &= -(iSi\omega_1 + \text{\&c.}) + (S.\omega_1i) \frac{d\sigma}{dx} + \text{\&c.} \\ &= \omega_1 + (S.\omega_1\nabla)\sigma, \text{ as before } \dots \dots \dots (11). \end{aligned}$$

Thus it appears that the equation of the ellipsoid may be written

$$T\{\omega + (S\omega\nabla)\sigma\} = e \dots \dots \dots (10).$$

3. The differential of this equation is

$$S\{\omega + (S\omega\nabla)\sigma\} \{d\omega + (Sd\omega\nabla)\sigma\} = 0,$$

whence, omitting the second order of small quantities, the normal vector is

$$\omega + (S\omega\nabla)\sigma + \nabla S\omega\sigma.$$

To find the axes we must therefore express that the normal is parallel to  $\omega$ , or

$$p\omega = (S\omega\nabla)\sigma + \nabla S\omega\sigma \dots \dots \dots (12),$$

where  $p$  is an undetermined scalar.

The most obvious method of solving this equation is to operate in succession by *S.i*, *S.j* and *S.k*. We thus obtain,

$$pSi\omega = S\omega\nabla Si\sigma + Si\nabla S\omega\sigma,$$

$$\&c. = \&c.$$

Or, remembering (5),  $S. \omega \left( pi + \nabla\xi + \frac{d\sigma}{dx} \right) = 0,$

$$\&c. = 0,$$

*p* is therefore a root of the equation

$$S. \left( pi + \nabla\xi + \frac{d\sigma}{dx} \right) \left( pj + \nabla\eta + \frac{d\sigma}{dy} \right) \left( pk + \nabla\zeta + \frac{d\sigma}{dz} \right) = 0,$$

or, as it may evidently be written,

$$\begin{vmatrix} p + 2 \frac{d\xi}{dx}, & \frac{d\xi}{dy} + \frac{d\eta}{dx}, & \frac{d\xi}{dz} + \frac{d\zeta}{dx} \\ \frac{d\xi}{dy} + \frac{d\eta}{dx}, & p + 2 \frac{d\eta}{dy}, & \frac{d\eta}{dz} + \frac{d\zeta}{dy} \\ \frac{d\xi}{dz} + \frac{d\zeta}{dx}, & \frac{d\eta}{dz} + \frac{d\zeta}{dy}, & p + 2 \frac{d\zeta}{dz} \end{vmatrix} = 0 \dots\dots\dots(13).$$

A value of *p* having been found from (13), the direction of the corresponding axis is given by

$$\omega \parallel V. \left( pi + \nabla\xi + \frac{d\sigma}{dx} \right) \left( pj + \nabla\eta + \frac{d\sigma}{dy} \right) \dots\dots\dots(14).$$

3 a. As a very simple example of distortion, suppose  $\rho$  to represent the position of each particle with regard to a centre attracting according to Newton's law, and let  $\sigma$  the vector of distortion be a small constant multiple of the vector force. Then

$$\frac{m}{T\rho} = C \text{ (the potential).}$$

Hence  $\sigma = \frac{gm\rho}{T\rho^3}$ , where *g* is very small,

$\therefore$  when  $\rho$  becomes  $\rho + \sigma$ ,  $\rho + \omega$  becomes  $\rho + \omega + \frac{gm(\rho + \omega)}{T(\rho + \omega)^3}$ . As *T* $\omega$  is exceedingly small, this may be written

$$\rho + \omega + \frac{gm(\rho + \omega)}{T\rho^3 \left( 1 - 3 \frac{S\omega\rho}{T\rho^2} \right)}.$$

Hence  $\omega_1 = \omega + \frac{gm}{T\rho^3} \left( \omega + 3\rho \frac{S\omega\rho}{T\rho^2} \right)$ , and an originally spherical surface  $T\omega = e$  (8) becomes after distortion approximately

$$T \left\{ \omega_1 - \frac{gm}{T\rho^3} \left( \omega_1 + 3\rho \frac{S\omega_1\rho}{T\rho^2} \right) \right\} = e,$$

a spheroid of revolution whose axis is  $\rho$ , as indeed is evident.

4. In this latter case we see at once that  $V\nabla\sigma = 0$ , and it is easy to show that in general, *if the small displacement of each point of a medium is in the direction of, and proportional to, the attraction exerted at that point by any system of masses, the displacement is effected without rotation.* For if  $F\rho = C$  be the potential surface, we have  $S\sigma d\rho$  a complete differential—i.e., in Cartesian co-ordinates  $\xi dx + \eta dy + \zeta dz$  is a differential of three independent variables. Hence the vector axis of rotation  $i \left( \frac{d\xi}{dy} - \frac{d\eta}{dz} \right) + \&c.$ , vanishes by the vanishing of each of its constituents, or  $V\nabla\sigma = 0$ .

Conversely, *if there be no rotation the displacements are in the direction of, and proportional to, the normal vectors to a series of surfaces.*

$$\text{For} \quad 0 = V \cdot d\rho V\nabla\sigma = (Sd\rho\nabla)\sigma - \nabla S\sigma d\rho.$$

Now, of the two terms on the right, the first is a complete differential, since it may be written  $-D_{d\rho}\sigma$  (see (7)), and therefore the remaining term must be so.

Thus, in a distorted system, there is no compression if

$$S\nabla\sigma = 0,$$

and no rotation if  $V\nabla\sigma = 0$ ; and evidently *merely transference* if  $\sigma = \alpha$ , a constant vector, which is one case of  $\nabla\sigma = 0$ .

In the important case of  $\sigma = e\nabla F\rho$  there is evidently no rotation, since  $\nabla\sigma = e\nabla^2 F\rho$  is evidently a scalar. In this case, then, there are only translation and compression, and the latter is at each point proportional to the density of a distribution of matter, which would give the potential  $F\rho$ . For if  $r$  be such density, we have at once  $\nabla^2 F\rho = 4\pi r$  (see (3)<sup>1</sup>). This suggests a host of physical analogies which we cannot enter upon at present.

5. Keeping still to the meaning of  $\sigma$  as the vector of displacement, as we have seen that  $\nabla\sigma = s + \iota$ , where  $s$  is the condensation of the particles near the extremity of  $\rho$ , and  $\iota$  the doubled vector axis of rotation of the group—we may apply the vector operation a second time. Thus,

$$\nabla^2\sigma = \nabla s + \nabla\iota.$$

Now, our former results enable us to assign meanings to these expressions.  $\nabla s$  is the normal-vector to any of the surfaces of equal condensation. The scalar and

vector parts of  $\nabla\iota$  represent the compression, and the doubled-axis of the rotation, consequent on the displacement of each point through a space represented by  $\iota$ . Also it is easy to see that  $\nabla^2\sigma$  is a pure vector. Hence

$$S.\nabla V\nabla\sigma = 0.$$

*If therefore there be two similar media, and the particles of one be slightly displaced in a continuous manner—the particles of the other being displaced through vectors proportional to the rotations at each point in the first mass—this displacement takes place without condensation.*

And, as  $V\nabla\nabla s = 0$ , we have the other result, that *if the particles of the second medium be displaced through vectors representing the direction and rate of most rapid change of compression in the first, such displacement will take place without rotation.* But this is merely another way of stating the first proposition in 4.—(Compare Thomson, “On a Mechanical Representation of Electric, Magnetic, and Galvanic Forces”—*Cambridge and Dublin Mathematical Journal*, vol. II.; and Maxwell, “On Physical Lines of Force”—*Philosophical Magazine*, 1861—62.)

### VII.

#### NOTE ON A QUATERNION TRANSFORMATION.

[*Proceedings of the Royal Society of Edinburgh, April 6, 1863.*]

THE following paper gives an idea of the nature of the physical applications of quaternions to which I referred in a previous note [VI. above], but which other avocations have, as yet, prevented me from developing into a form and bulk suitable for publication in the Society's Transactions. The equations I now give form the *basis* of the investigations in question, which I hope to present to the Society in detail on some future occasion.

1. If the vector of any point be denoted by

$$\rho = ix + jy + kz \dots\dots\dots(1),$$

there are many interesting and important transformations depending upon the effects of the quaternion operator

$$\nabla = i \frac{d}{dx} + j \frac{d}{dy} + k \frac{d}{dz} \dots\dots\dots(2),$$

upon various functions of  $\rho$ . When the function of  $\rho$  is a scalar, the effect of  $\nabla$  is to give the vector of most rapid increase. Its effect on a vector function is indicated briefly in my former note.

2. I shall commence with one or two very simple examples, which are not only interesting, but, as we shall see, very useful in subsequent transformations.

$$\nabla \rho = \left( i \frac{d}{dx} + \&c. \right) (ix + \&c.) = -3 \dots\dots\dots(3),$$

$$\nabla T\rho = \left( i \frac{d}{dx} + \&c. \right) (x^2 + y^2 + z^2)^{\frac{1}{2}} = \frac{ix + jy + kz}{(x^2 + y^2 + z^2)^{\frac{1}{2}}} = \frac{\rho}{T\rho} = U\rho \dots\dots\dots(4),$$

$$\nabla (T\rho)^n = n (T\rho)^{n-1} \cdot \nabla T\rho = n (T\rho)^{n-2} \cdot \rho \dots\dots\dots(5),$$

and, of course,

$$\nabla \frac{1}{(T\rho)^n} = - \frac{n\rho}{(T\rho)^{n+2}} \dots\dots\dots(5)^1,$$

whence

$$\nabla \frac{1}{T\rho} = - \frac{\rho}{T\rho^3} = - \frac{U\rho}{T\rho^2} \dots\dots\dots(6),$$

and, of course,

$$\nabla^2 \frac{1}{T\rho} = - \nabla \frac{U\rho}{T\rho^2} = 0 \dots\dots\dots(6)^1.$$

Also,

$$\nabla \rho = -3 = T\rho \nabla U\rho + \nabla T\rho \cdot U\rho = T\rho \nabla U\rho - 1,$$

therefore

$$\nabla U\rho = - \frac{2}{T\rho} \dots\dots\dots(7).$$

3. By the help of the above results, of which (6) is especially useful (though obvious on other grounds), and (4) and (7) very remarkable, we may easily find the effect of  $\nabla$  upon more complex functions.

Thus

$$\nabla S\alpha\rho = - \nabla (ax + \&c.) = - \alpha \dots\dots\dots(8),$$

$$\nabla V\alpha\rho = - \nabla V\rho\alpha = - \nabla (\rho\alpha - S\alpha\rho) = 3\alpha - \alpha = 2\alpha \dots\dots\dots(9).$$

Hence

$$\nabla \frac{V\alpha\rho}{T\rho^3} = \frac{2\alpha}{T\rho^3} - \frac{3\rho V\alpha\rho}{T\rho^5} = - \frac{2\alpha\rho^2 + 3\rho V\alpha\rho}{T\rho^5} = \frac{\alpha\rho^2 - 3\rho S\alpha\rho}{T\rho^5} \dots\dots\dots(10).$$

Hence

$$S \cdot \delta\rho \nabla \frac{V\alpha\rho}{T\rho^3} = \frac{\rho^2 S\alpha\delta\rho - 3S\alpha\rho S\rho\delta\rho}{T\rho^5} = - \frac{S\alpha\delta\rho}{T\rho^3} - \frac{3S\alpha\rho S\rho\delta\rho}{T\rho^5} = - \delta \frac{S\alpha\rho}{T\rho^3} \dots\dots\dots(11).$$

This is the principal transformation alluded to in the title of this note. By (6) it can be put in the sometimes more convenient form

$$S \cdot \delta\rho \nabla \frac{V\alpha\rho}{T\rho^3} = \delta S\alpha \nabla \frac{1}{T\rho} \dots\dots\dots(12).$$

And it is worthy of remark that, as may easily be seen,  $S$  may be put for  $V$  in the left-hand member of the equation. [This follows at once from  $K(\alpha\rho) = \rho\alpha$  1897.]

We have also

$$\nabla V \cdot \beta\rho\gamma = \nabla \{ \beta S\gamma\rho - \rho S\beta\gamma + \gamma S\beta\rho \} = - \gamma\beta + 3S\beta\gamma - \beta\gamma = S\beta\gamma \dots\dots\dots(13).$$

Hence, if  $\phi$  be any self-conjugate linear and vector function of the form

$$\phi\rho = \Sigma V \cdot \beta\rho\gamma + m\rho \dots\dots\dots(14),$$

then

$$\nabla \phi\rho = \Sigma S\beta\gamma - 3m = \text{scalar} \dots\dots\dots(14)^1.$$

Hence, an integral of

$$\nabla \sigma = \text{scalar constant, is } \sigma = \phi\rho \dots\dots\dots(15).$$

If the constant value of  $\nabla\sigma$  contain a vector part, there will be a term of the form  $V\epsilon\rho$  in the expression for  $\sigma$ , which will then express a distortion accompanied by rotation.

Also, a solution of  $\nabla q = a$  (where  $q$  and  $a$  are quaternions) is  $q = S\zeta\rho + V\epsilon\rho + \phi\rho$ .

It may be remarked also, as of considerable importance in physical applications, that, by (8) and (9),  $\nabla(S + \frac{1}{2}V)\alpha\rho = 0$ , but I cannot enter at present into details on this point.

4. In this brief note, I shall not give any more of these transformations, which really present no difficulty; but I shall show the ready applicability to physical questions of one or two of those already obtained, a property of great importance, as it may now be asserted that the next grand extensions of mathematical physics will, in all likelihood, be furnished by quaternions.

Thus, if  $\sigma$  be the vector-displacement of that point of a homogeneous elastic solid whose vector is  $\rho$ , we have,  $p$  being the consequent pressure produced,

$$\nabla p + \nabla^2\sigma = 0 \dots\dots\dots(16),$$

whence  $S\delta\rho\nabla^2\sigma = -S\delta\rho\nabla p = \delta p$ , a complete differential.....(16)!

Also, generally,  $p = kS\nabla\sigma$ ,

and if the solid be incompressible

$$S\nabla\sigma = 0 \dots\dots\dots(17).$$

Thomson has shown (*Camb. and Dub. Math. Journal*, II. p. 62), that the forces produced by given distributions of matter, electricity, magnetism, or galvanic currents, can be represented at every point by displacements of such a solid producible by external forces. It may be useful to give his analysis, with some additions, in a quaternion form, to show the insight gained by the simplicity of the present method.

Thus, if  $S\sigma\delta\rho = \delta \frac{1}{T\rho}$ , we may write each equal to  $-S\delta\rho\nabla \frac{1}{T\rho}$ . This gives

$$\sigma = -\nabla \frac{1}{T\rho}$$

the vector-force exerted by one particle of matter or free electricity on another. This value of  $\sigma$  evidently satisfies (16)! and (17).

Again, if  $S \cdot \delta\rho\nabla\sigma = \delta \frac{S\alpha\rho}{T\rho^3}$ , either is equal to

$$-S \cdot \delta\rho\nabla \frac{V\alpha\rho}{T\rho^3} \text{ by (11).}$$

Here a particular case is  $\sigma = -\frac{V\alpha\rho}{T\rho^3}$ , which [III. above, § 12] is the vector-force exerted by an element  $\alpha$  of a current upon a particle of magnetism at  $\rho$ .

Also, by (10),  $\nabla \frac{V\alpha\rho}{T\rho^3} = \frac{\alpha\rho^2 - 3\rho S\alpha\rho}{T\rho^5}$ , and the same paper shows that this is the vector-force exerted by a small plane current at the origin (its plane being perpendicular to  $\alpha$ ) upon a magnetic particle, or pole of a solenoid, at  $\rho$ . This expression, being a pure vector, denotes an elementary rotation caused by the distortion of the solid, and it is evident that the above value of  $\sigma$  satisfies the equations (16)<sup>1</sup>, (17), and the distortion is therefore producible by external forces. Thus the effect of an element of a current on a magnetic particle is expressed directly by the displacement, while that of a small closed current or magnet is represented by the vector-axis of the rotation caused by the displacement.

Again, let 
$$S\delta\rho\nabla^2\sigma = \delta \frac{S\alpha\rho}{T\rho^3}.$$

It is evident that  $\sigma$  satisfies (16)<sup>1</sup>, and that the right-hand side of the above equation may be written

$$-S \cdot \delta\rho \nabla \frac{V\alpha\rho}{T\rho^3}.$$

Hence a particular case is  $\nabla\sigma = -\frac{V\alpha\rho}{T\rho^3}$ , and this satisfies (17) also. Hence the corresponding displacement is producible by external forces, and  $\nabla\sigma$  is the rotation axis of the element at  $\rho$ , and is seen as before to represent the vector-force exerted on a particle of magnetism at  $\rho$  by an element  $\alpha$  of a current at the origin.

It is interesting to observe that a particular value of  $\sigma$  in this case is

$$\sigma = -\frac{1}{2}\nabla S\alpha U\rho - \frac{\alpha}{T\rho^3},$$

as may easily be proved by substitution.

Again, if 
$$S\delta\rho\sigma = -\delta \frac{S\alpha\rho}{T\rho^3},$$

we have evidently 
$$\sigma = \nabla \frac{S\alpha\rho}{T\rho^3}.$$

Now, as  $\frac{S\alpha\rho}{T\rho^3}$  is the potential of a small magnet  $\alpha$ , at the origin, on a particle of free magnetism at  $\rho$ ,  $\sigma$  is the resultant magnetic force—and represents also a possible distortion of the elastic solid by external forces, since  $\nabla\sigma = \nabla^2\sigma = 0$ , and thus (16)<sup>1</sup> and (17) are both satisfied.



## VIII.

## ON THE LAW OF FREQUENCY OF ERROR.

[*Transactions of the Royal Society of Edinburgh*, Vol. xxiv.

Read 3rd January, 1865.]

1. It has always appeared to me that the difficulties which present themselves in investigations concerning the Frequency of Error, and the deduction of the most probable result from a large number of observations by the *Method of Least Squares* (which is an immediate consequence of the ordinary "Law of Error"), are difficulties of reasoning, or logic, rather than of analysis. Hence I conceive that the elaborate analytical investigations of Laplace, Poisson, and others, do not in anywise present the question in its intrinsic simplicity. They seem to me to be necessitated by the unnatural point of view from which their authors have contemplated the question. It is, undoubtedly, a difficult one; but this is a strong reason for abstaining from the use of unnecessarily elaborate analysis, which, however beautiful in itself, does harm when it masks the real nature of the difficulty it is employed to overcome. I believe that, so far at least as mathematics is concerned, the subject ought to be found extremely simple, if we only approach it in a natural manner.

2. It occurred to me lately, while I was writing an elementary article on the Theory of Probabilities, that such a natural process might possibly be obtained by taking as the basis one of the common problems in probabilities, viz.:—*To find the relative probabilities of different combinations of mutually exclusive simple events in the course of a large number of trials.*

3. In fact, this is really the basis of Laplace's investigation, an elegant, but very troublesome piece of analysis. With the view, apparently, of attaining the utmost possible generality, he considers an error to be made up of an infinite number of

contributions, each from a separate source. But he assumes at starting, that these separate contributions are as likely to be of one magnitude as another, which is, to say the least, questionable; as it seems to be inconsistent with the result finally arrived at. For instance, by far the larger part of the probability of a given finite error is thus made to depend upon a great number of infinite positive contributions, combined with a proper allowance of infinite negative ones. Now, though it is not a harsh assumption to suppose that finite effects should be, in certain cases, the results of additive and subtractive operations with infinite quantities, it does appear unlikely in the extreme, that finite effects should be due to such operations in a far greater measure than to operations with finite quantities. It is true that Laplace subsequently shows that the same law will be arrived at by assuming any law of probability for the contributions to the error from each separate cause, provided positive and negative errors of equal amount are equally likely; but it is the complexity, not the sufficiency, of his processes, which I think requires attention.

4. Gauss' investigation is founded on the assumption, that *the arithmetical mean, of the results deduced from equally trustworthy observations, is the most probable value of the quantity sought*. So far as I can see, Ellis\* has satisfactorily shown that this, however apparently natural, is not justifiable as an *à priori* assumption. In fact, it would seem that we have no right to assume that, because errors of equal magnitude and opposite signs are equally likely, their *sum* will vanish in a large number of trials, any more than that the sum of their third or fifth powers will vanish. Why the first powers should be chosen, appears to arise from the extreme simplicity of the requisite operations; yet, though complexity of calculations is undesirable, it must be submitted to, if necessary for the evolution of truth. The principle of the arithmetical mean has been adopted, among a multitude of others equally likely, just as we might suppose a calculator to insist on gravity varying as the direct distance instead of its inverse square, on the ground that the problem of Three Bodies would then become as simple and its solution as exact, as they are now complicated, and at best only approximate. "*La nature ne s'est pas embarrassée des difficultés d'analyse, elle n'a évité que la complication des moyens,*" in the words of Fresnel.

5. It is with some hesitation that I communicate the present paper to the Society; for I have not devoted much time to the study of the Theory of Probabilities; and I know well how easy it is to fall into the gravest errors of reasoning on such a subject, from the fact that D'Alembert, Ivory, and many others, have published investigations and proofs (sometimes in its most elementary parts), which are now seen to be entirely fallacious.

6. I proceed to show how I think the principle, above (§ 2) enunciated, may be applied. The most direct method would be, of course, to assume any one set of causes of error whatever, and to determine what will, in the long run, be the chance of each separate amount of error as due to their joint action. Supposing this to be determined, let us try to combine the probabilities of error from any indefinite number of sets of

\* *Cambridge Phil. Trans.*, VIII. p. 205.

possible causes; and, if this process should lead to a definite law of error, such will be the law to which, by an inverse application of the Theory of Probabilities, we should expect each separate observation to be subject. But this process, which is analogous to that of Laplace, though not identical with it, cannot easily be carried out, for it essentially involves in its first steps the assumption of a law of error which it is the object of the investigation to determine. We must try a less direct method.

7. We shall, therefore, investigate what must be, in the long run, the chance of any combination whatever of independent events, and *consider the deviation of this combination from the most probable combination as the Error, and the ratio of its probability to that of the most probable combination, as the function which expresses the Law of Error.* If we find, as we proceed, that the law thus arrived at, is (in form at least) totally independent of the number, variety, &c., of the several simultaneously acting causes, we shall thus have a very strong argument in favour of the correctness of the process; whose real difficulty, be it remembered, is logical and not mathematical. The mathematical processes to be employed below are, of course, known, and will be found in most treatises on Algebra; but, for the present application, it will be convenient to put them in a form slightly different from the usual one.

8. Taking the simplest case, let us suppose a bag to contain white and black balls, whose numbers are as  $p : q$ , where  $p + q = 1$ . The chance of drawing  $\alpha$  white, and  $\beta$  black, balls in  $n (= \alpha + \beta)$  drawings, replacing before each drawing, and disregarding the order in which they appear, is

$$\frac{n!}{\alpha! \beta!} p^\alpha q^\beta \dots\dots\dots (1).$$

This is a maximum, when  $\alpha : \beta :: p : q$ ; which, when  $n$  is indefinitely great, can always be exactly attained. This maximum value is

$$\frac{n!}{pn! qn!} p^{pn} q^{qn} \dots\dots\dots (2).$$

The ratio of these two numbers is

$$\frac{pn! qn!}{\alpha! \beta!} p^{\alpha-pn} q^{\beta-qn} \dots\dots\dots (3).$$

Now, according to the principle above assumed, we must treat  $\alpha - pn$ , the deviation from the most probable result, as measuring the error in some observation, while the expression (3) measures the probability of it, as compared with that of the most probable result. To introduce the ordinary notation, let  $x$  be the error, and  $y$  the (indefinitely small) probability of that error; then,  $A$  and  $m$  being constants,

$$\alpha - pn = mx \dots\dots\dots (4),$$

while  $y$  may be expressed as the product of (3) into  $A$ , that is, by (4),

$$y = A \frac{pn! qn!}{pn + mx! qn - mx!} p^{mx} q^{-mx} \dots\dots\dots (5).$$

When  $n$  is a large number, the value of this is easily found from Stirling's Theorem, viz.,

$$1 \cdot 2 \cdot 3 \dots n = n! = \sqrt{2\pi} n^{n+\frac{1}{2}} \epsilon^{-n} \left(1 + \frac{1}{12n} + \&c.\right),$$

where the inverse powers of  $n$  may be neglected if  $n$  is large. For (5) thus becomes

$$\begin{aligned} y &= A \frac{(pn)^{pn+\frac{1}{2}+mx} (qn)^{qn+\frac{1}{2}-mx}}{(pn+mx)^{pn+mx+\frac{1}{2}} (qn-mx)^{qn-mx+\frac{1}{2}}} \\ &= A \frac{1}{\left(1 + \frac{mx}{pn}\right)^{pn+mx+\frac{1}{2}} \left(1 - \frac{mx}{qn}\right)^{qn-mx+\frac{1}{2}}}. \end{aligned}$$

Hence,

$$\begin{aligned} \log y - \log A &= -(pn+mx+\frac{1}{2}) \log \left(1 + \frac{mx}{pn}\right) - (qn-mx+\frac{1}{2}) \log \left(1 - \frac{mx}{qn}\right) \\ &= -(pn+mx+\frac{1}{2}) \left\{ \frac{mx}{pn} - \frac{m^2x^2}{2p^2n^2} + \frac{m^3x^3}{3p^3n^3} - \&c. \right\} \\ &\quad - (qn-mx+\frac{1}{2}) \left\{ -\frac{mx}{qn} - \frac{m^2x^2}{2q^2n^2} - \frac{m^3x^3}{3q^3n^3} - \&c. \right\} \\ &= -\frac{m^2x^2}{2n} \left(\frac{1}{p} + \frac{1}{q}\right) + \frac{m^3x^3}{6n^2} \left(\frac{1}{p^2} - \frac{1}{q^2}\right) - \frac{m^4x^4}{12n^3} \left(\frac{1}{p^3} + \frac{1}{q^3}\right) + \&c. \\ &\quad - \frac{mx}{2n} \left(\frac{1}{p} - \frac{1}{q}\right) + \frac{m^2x^2}{4n^2} \left(\frac{1}{p^2} + \frac{1}{q^2}\right) + \&c. \end{aligned}$$

The first term of this expression is finite when  $mx$  is of the order  $n^{\frac{1}{2}}$ ; and in this case the other terms in the first line are infinitely small, being of the orders  $n^{-\frac{1}{2}}$ ,  $n^{-1}$ , &c. respectively. The latter remark applies to the second line of the expression, which depends upon the  $\frac{1}{2}$  in the exponents. When  $mx$  is of an order higher than  $n^{\frac{1}{2}}$ , it is obvious from the undeveloped form that the expression must be infinitely large, and negative. Hence, generally, we may neglect all but the first term, and we have therefore

$$\begin{aligned} y &= A \epsilon^{-\frac{m^2x^2}{2pn}} \\ &= A \epsilon^{-\mu x^2} \dots\dots\dots(6), \end{aligned}$$

which is the ordinary expression.

9. This shows that, as is well known, the chance of a result differing  $x$  from the most probable combination is, in this very simple case, represented by a number proportional to  $\epsilon^{-\mu x^2}$  times that of the most probable event. But if we now consider, not *one* but, *any number of* causes conspiring to produce the observed result, we find that the law is still precisely the same in *form*, and this *whether the most probable event be the same as regards each cause or not*. And it is this fact which appears completely to justify the proposed method of regarding the question.

10. For, if the various causes all tend to produce the *same* most probable event, its probability will be, by (6),

$$\mathfrak{A} = A_1 A_2 A_3 \dots A_\nu \dots \dots \dots (7),$$

while that of a result, whose error is  $x$ , will be

$$y = y_1 y_2 y_3 \dots y_\nu = \mathfrak{A} \epsilon^{-(\mu_1 + \mu_2 + \dots + \mu_\nu) x^2} = \mathfrak{A} \epsilon^{-Mx^2} \dots \dots \dots (8)$$

(where  $M = \mu_1 + \mu_2 + \mu_3 + \dots + \mu_\nu$ ),

which is the same form as (6).

If the most probable result, as depending on the several sets of causes, be different for each, the formula (6) becomes, for any one cause,

$$y = A \epsilon^{-\mu(x-\gamma)^2} \dots \dots \dots (9),$$

where  $A$  is the (small) chance of the most probable result, which is, of course,  $x = \gamma$ .

The chance of any particular value of  $x$ , as due to the simultaneous action of all the causes, is now

$$y = A_1 \dots A_\nu \epsilon^{-\mu_1(x-\gamma_1)^2 - \dots - \mu_\nu(x-\gamma_\nu)^2} \dots \dots \dots (10),$$

which may, of course, be put in the form

$$y = \mathfrak{A} \epsilon^{-M(x-\Gamma)^2} \dots \dots \dots (11),$$

where the most probable result is now

$$x = \Gamma = \frac{\mu_1 \gamma_1 + \mu_2 \gamma_2 + \dots + \mu_\nu \gamma_\nu}{\mu_1 + \mu_2 + \dots + \mu_\nu},$$

while

$$\mathfrak{A} = A_1 \dots A_\nu \epsilon^{-(\mu_1 \gamma_1^2 + \dots + \mu_\nu \gamma_\nu^2) + M\Gamma^2}$$

(where, as before,  $M = \mu_1 + \mu_2 + \dots + \mu_\nu$ )

is its probability.

If we take this as our point of departure for the error  $x$ , we must write  $x$  for  $x - \Gamma$ , and we have

$$y = \mathfrak{A} \epsilon^{-Mx^2} \dots \dots \dots (12),$$

for the form of the law of error, which is precisely that of (6) deduced from the simplest conceivable case.

11. Another remarkable confirmation of the validity of the process suggested above, is to be found in the fact that not only are the *curves* expressed by equations such as (6) and (9) compounded, by multiplication of corresponding ordinates, into another of the same class, whatever be the positions of their axes of symmetry, but that the same principle holds good in three, four, &c., dimensions also.

Thus, any number of hills on the plane of  $xy$ , represented by equations such as

$$z = A \epsilon^{-\mu[(x-a)^2 + (y-\beta)^2]} \dots \dots \dots (13),$$

give, by multiplication of their corresponding ordinates, another hill of the same general form, the *values* only of the constants being changed.

[Many curious geometrical results may be derived from this construction. One of the most singular is the fact that the projection on  $xy$  of the line of intersection of any two surfaces whose equations are of the form (13) is a *circle*, and that another such surface (viz., that whose ordinates are mean proportionals between those of the former) can be described, passing through the curve of double curvature of which this circle is the projection. But, besides being foreign to our subject, these theorems follow at once from well-known properties of circles.]

12. Returning to equation (12), it is obvious that  $\mathfrak{A}$  and  $M$  must be connected, since we have to satisfy the condition that the probability that the error lies between infinite positive and negative limits is certainty. Hence, as we may write

$$\mathfrak{A} \int_{-\infty}^{+\infty} \epsilon^{-Mx^2} \delta x \dots\dots\dots(14),$$

for the chance that the error lies between  $x$  and  $x + \delta x$ ; we must have

$$\mathfrak{A} \int_{-\infty}^{+\infty} \epsilon^{-Mx^2} dx = 1 \dots\dots\dots(15).$$

But we know that

$$\int_{-\infty}^{+\infty} \epsilon^{-y^2} dy = \sqrt{\pi},$$

which reduces (15) at once to the form

$$\mathfrak{A} \sqrt{\frac{\pi}{M}} = 1 \dots\dots\dots(16),$$

the required relation.

13. It is obvious from (12) that large errors have less probability when  $M$  is large; that is when  $h$  is small, if we put

$$M = \frac{1}{h^2}.$$

Hence  $h$  becomes an indication of the comparative accuracy of the process whose errors we are testing, and it is thus desirable to retain it in the expression for the law of error.

By (16) we have 
$$\mathfrak{A} = \frac{1}{h \sqrt{\pi}},$$

and therefore, by (14), we obtain

$$\frac{1}{h \sqrt{\pi}} \epsilon^{-\frac{x^2}{h^2}} \delta x,$$

for the chance that the error lies between  $x$  and  $x + \delta x$ , the usual expression.

14. It only remains that we give an idea of the accuracy with which this law of error is approximated to, in cases such as we have assumed as the basis of our reasoning, even in a very small number of trials. For this purpose we take the case of 20 tosses

of a coin. Here the most probable result is, of course, 10 heads and 10 tails, and the chances of the various possible combinations are the terms of the expansion of

$$\left(\frac{1}{2} + \frac{1}{2}\right)^{20}.$$

If we erect these as ordinates at successive distances, each equal to unit, along a line, we may graphically represent their relative values by a curve drawn, *liberâ manu*, through their extremities. The area of this curve will evidently approximate to unity, which is the exact value of the sum of the areas of the rectangles of unit breadth, each of which is bisected by one of the ordinates laid down from the expansion.

To find the corresponding curve of error, notice that the maximum ordinate is

$$\frac{20 \cdot 19 \dots 11}{1 \cdot 2 \dots 10} \cdot \frac{1}{2^{20}} = \frac{184756}{1048576} = 0.1762.$$

Taking this as the value of  $\frac{1}{h\sqrt{\pi}}$  we have for (12) the expression

$$y = \frac{1}{5.675} e^{-\frac{x^2}{10.253}} \dots \dots \dots (17).$$

The following table shows a few of the values of  $y$  from this formula, compared with the corresponding terms in the binomial: it is sufficient for our purpose, as it would not be worth while to take the trouble of calculating the *areas* of the curve of error corresponding respectively to the rectangles above mentioned.

$x$	$y$ from (17)	$y$ from Binomial	Difference
0	0.1762	0.1762	0.0000
1	0.1598	0.1602	- 0.0004
2	0.1193	0.1201	- 0.0008
3	0.0733	0.0739	- 0.0006
4	0.0370	0.0369	+ 0.0001
5	0.0154	0.0148	+ 0.0006
6	0.0053	0.0046	+ 0.0007

15. Nothing is better calculated to show the general soundness of the method we have adopted in this paper, than the fact of the excessive closeness of the above approximation: the case having been specially chosen as one in which we could hardly have expected more than a rude resemblance to the law of error.

## IX.

ON THE APPLICATION OF HAMILTON'S CHARACTERISTIC  
FUNCTION TO SPECIAL CASES OF CONSTRAINT.

[*Transactions of the Royal Society of Edinburgh*, Vol. xxiv.

Read 20th March, 1865.]

1. ONE of the grandest steps which has ever been made in Dynamical Science is contained in two papers, "On a General Method in Dynamics," contributed to the *Philosophical Transactions* for 1834 and 1835 by Sir W. R. Hamilton. It is there shown that the complete solution of any kinetical problem, involving the action of a given conservative system of forces, and constraint depending upon the reaction of smooth guiding curves or surfaces, also given, is reducible to the determination of a single quantity called the *Characteristic Function* of the motion. This quantity is to be found from a partial differential equation of the first order, and second degree; and it has been shown that, from any *complete* integral of this equation, all the circumstances of the motion may be deduced by differentiation. So far as I can discover, this method has not been applied to inverse problems, of the nature of the Brachistochrone for instance, where the object aimed at is essentially the determination of the constraint requisite to produce a given result. It is easy to see, however, that a large class of such questions may be treated successfully by a process perfectly analogous to that of Hamilton; though the characteristic function in such cases is not the same function (of the quantities determining the motion) as that of the Method of *Varying Action*.

2. It is unnecessary to enter into any great detail with reference to the present subject; because any one who is familiar with Hamilton's beautiful investigations will have no difficulty in applying them, with the requisite slight modifications, to



the subject of this paper. I shall therefore content myself with a brief explanation of the application of the method to the problem of the Brachistochrone, and a mere indication of some other curious problems which are easily solved in a similar manner.

3. The problem of the Brachistochrone for a single particle is, in its simplest form, as follows:—

*Find the form of the (smooth) constraining curve along which a particle will pass, under the action of a given conservative system of forces, from one given point to another in the least possible time, the initial speed being given.*

The problem may easily be complicated by supposing, for instance, the terminal points not to be definitely assigned, but to lie each on a given surface: still farther, by supposing the initial speed to depend, according to some given law, upon the coordinates of the initial point, and so forth. But such complications introduce analytical difficulties of the quasi-arithmetical kind merely, not of a physical nature; and we leave them to those who are curious in such matters.

4. In symbols, if  $\tau$  be the time of passing from  $x_0, y_0, z_0$  to  $x, y, z$ , we must have

$$\tau = \int_{x_0, y_0, z_0}^{x, y, z} \frac{ds}{v}$$

a minimum: subject to the sole condition

$$v^2 = 2(H - V)$$

where  $H$  is the whole energy, and  $V$  the potential of the system of forces on unit mass at the point  $x, y, z$ .

Hence, taking the variation,

$$\delta\tau = \int \left( \frac{d\delta s}{v} - \frac{ds\delta v}{v^2} \right).$$

But  $dsd\delta s = dx d\delta x + dy d\delta y + dz d\delta z$ ;

and  $v\delta v = \delta(H - V) = X\delta x + Y\delta y + Z\delta z + \delta H$ ,

if  $X, Y, Z$  be the component forces on unit mass at  $x, y, z$ . Thus we have

$$\begin{aligned} \delta\tau = & \left[ \frac{1}{v^2} \left( \frac{dx}{dt} \delta x + \frac{dy}{dt} \delta y + \frac{dz}{dt} \delta z \right) - \delta H \int \frac{ds}{v^2} \right] \\ & - \int \left\{ \delta x \left[ d \left( \frac{dx}{v^2} \right) + \frac{X dt}{v^2} \right] + \&c. \right\}; \end{aligned}$$

where the whole, integrated or not, is to be taken between the given limits.

If the limits and the initial speed be fixed, the first part of the expression for  $\delta\tau$  disappears; and, that the integral may vanish, we must have

$$d\left(\frac{dx}{v^2}\right) + \frac{Xdt}{v^2} = 0 \dots\dots\dots(A),$$

with similar equations in  $y$  and  $z$ . This is simply the ordinary result given in treatises on kinetics.

But if we consider the effect of the alteration of the limits, or of the initial energy, we have

$$\left. \begin{aligned} \frac{\delta\tau}{\delta x} &= \frac{1}{v^2} \frac{dx}{dt}, & \frac{\delta\tau}{\delta x_0} &= -\left(\frac{1}{v^2} \frac{dx}{dt}\right)_0, \\ &\&c. & &\&c. \end{aligned} \right\} \dots\dots\dots(1).$$

and 
$$\frac{\delta\tau}{\delta H} = -\int_{x_0, y_0, z_0}^{x, y, z} \frac{ds}{v^3}.$$

5. Hence, if  $\tau$  could be found as a function of  $x, y, z, x_0, y_0, z_0,$  and  $H,$  it is obvious that its partial differential coefficients with respect to these quantities would give the motion completely.

But, neglecting altogether the initial limit, we see that

$$\begin{aligned} \left(\frac{d\tau}{dx}\right)^2 + \left(\frac{d\tau}{dy}\right)^2 + \left(\frac{d\tau}{dz}\right)^2 &= \frac{1}{v^4} \left\{ \left(\frac{dx}{dt}\right)^2 + \left(\frac{dy}{dt}\right)^2 + \left(\frac{dz}{dt}\right)^2 \right\} \\ &= \frac{1}{v^2} = \frac{1}{2(H - V)} \dots\dots\dots(2). \end{aligned}$$

6. It can be easily shown, by a process similar to that employed for *Varying Action\**, that, if any integral of this equation can be found, its partial differential coefficients with respect to  $x, y, z$  are respectively equal to the corresponding speed-components of the velocity, in a curve which is a brachistochrone for the given forces, *each divided by the square of the speed.*

A *complete* integral of (2) must of course contain, besides  $H,$  two arbitrary constants  $\alpha, \beta.$  If, then,  $\tau$  be a complete integral, the equations of the brachistochrone are easily shown to be

$$\frac{d\tau}{d\alpha} = \mathfrak{A}, \quad \frac{d\tau}{d\beta} = \mathfrak{B} \dots\dots\dots(3);$$

where  $\mathfrak{A}$  and  $\mathfrak{B}$  are two new arbitrary constants.

Also we have the relation

$$\frac{d\tau}{dH} = -\int \frac{dt}{v^2} = -\int \frac{ds}{v^3} \dots\dots\dots(4).$$

\* Thomson and Tait's *Natural Philosophy*, § 323, or Tait and Steele's *Dynamics of a Particle* (2nd edition), §§ 252, 253.

7. Before proceeding farther with the theory, we may apply the results already obtained to one or two well-known problems; commencing with the original case proposed by Bernoulli.

8. *To find the brachistochrone, when gravity is the only impressed force, and the particle has the speed due to a fall from a given horizontal plane.*

Taking the axis of  $y$  vertically downwards, we have

$$V = -gy.$$

Also, we may write

$$H = gu.$$

Hence 
$$\left(\frac{d\tau}{dx}\right)^2 + \left(\frac{d\tau}{dy}\right)^2 + \left(\frac{d\tau}{dz}\right)^2 = \frac{1}{2g(a+y)}.$$

This equation is obviously satisfied by

$$\left(\frac{d\tau}{dx}\right) = M, \quad \left(\frac{d\tau}{dz}\right) = N, \quad \left(\frac{d\tau}{dy}\right)^2 = \frac{1}{2g(a+y)} - M^2 - N^2.$$

But

$$\frac{\left(\frac{d\tau}{dx}\right)}{\left(\frac{d\tau}{dz}\right)} = \frac{\frac{dx}{dt}}{\frac{dz}{dt}} \text{ (by § 4) } = \frac{dx}{dz}.$$

Hence  $\frac{dx}{dz} = \frac{M}{N}$ , that is *the path is in a vertical plane*. We may take this as the plane of  $xy$ . Hence our equation becomes

$$\left(\frac{d\tau}{dx}\right)^2 + \left(\frac{d\tau}{dy}\right)^2 = \frac{1}{2g(a+y)}.$$

We may now write

$$\left. \begin{aligned} \frac{d\tau}{dx} &= \frac{1}{\sqrt{2gb}} \\ \left(\frac{d\tau}{dy}\right)^2 &= \frac{1}{2g} \left( \frac{1}{a+y} - \frac{1}{b} \right) \end{aligned} \right\} \dots\dots\dots (5),$$

where  $b$  is an arbitrary constant.

By (5) we have, at once,  $\sqrt{2g}\tau = \frac{x}{\sqrt{b}} + \int dy \sqrt{\frac{1}{a+y} - \frac{1}{b}} \dots\dots\dots (6).$

Hence the equation of the brachistochrone is (by § 6)

$$\frac{d\tau}{db} = \text{const.}$$

or

$$C = -\frac{x}{b^{\frac{3}{2}}} + \frac{1}{b^2} \int \frac{dy}{\sqrt{\frac{1}{a+y} - \frac{1}{b}}};$$

that is, changing the constant, and effecting the integration,

$$C_1 = -x - \sqrt{(b-a+y)(a+y)} + \frac{b}{2} \text{vers.}^{-1} \frac{2(a+y)}{b}.$$

the common equation of the *Cycloid*, the speed at any point being that due to a fall from the base.

In this case we have evidently

$$\begin{aligned} \frac{d\tau}{dH} &= -\int \frac{ds}{v^3} = \frac{1}{g} \frac{d\tau}{du} = -\frac{1}{2\sqrt{2g^3}} \int \frac{dy}{(a+y)^2 \sqrt{\frac{1}{a+y} - \frac{1}{b}}} \\ &= \frac{1}{\sqrt{2g^3}} \sqrt{\frac{1}{a+y} - \frac{1}{b}} + C_2. \end{aligned}$$

The above (at first sight apparently too limited) assumptions

$$\frac{d\tau}{dx} = M, \quad \frac{d\tau}{dz} = N,$$

and the consequent reduction of the question to a *plane* problem, may seem to require some justification. This is easily supplied, thus: in the equation

$$\left(\frac{d\tau}{dx}\right)^2 + \left(\frac{d\tau}{dy}\right)^2 + \left(\frac{d\tau}{dz}\right)^2 = F^2,$$

the direction-cosines of the tangent to the brachistochrone, at the point  $x, y, z$ , are by (1),

$$l = \frac{1}{F} \frac{d\tau}{dx}, \quad m = \frac{1}{F} \frac{d\tau}{dy}, \quad n = \frac{1}{F} \frac{d\tau}{dz}.$$

At the adjacent point  $x + \delta x, y + \delta y, z + \delta z$ , where we have, of course,

$$\frac{\delta x}{l} = \frac{\delta y}{m} = \frac{\delta z}{n} = \delta s,$$

the value of  $l$  becomes

$$\begin{aligned} l' &= \frac{\frac{d\tau}{dx} + \frac{d^2\tau}{dx^2} \delta x + \frac{d^2\tau}{dx dy} \delta y + \frac{d^2\tau}{dx dz} \delta z}{F + \delta F} \\ &= \frac{\frac{d\tau}{dx} + \frac{\delta s}{F} \left( \frac{d\tau}{dx} \frac{d^2\tau}{dx^2} + \frac{d\tau}{dy} \frac{d^2\tau}{dx dy} + \frac{d\tau}{dz} \frac{d^2\tau}{dx dz} \right)}{F + \delta F} \\ &= \frac{\frac{d\tau}{dx} + \left(\frac{dF}{dx}\right) \delta s}{F + \delta F}. \end{aligned}$$

But in the above problem  $F$  is a function of  $y$  only, and we must therefore have

$$\frac{l'}{n'} = \frac{l}{n},$$

which shows that the curve is in a plane parallel to the axis of  $y$ .

9. To find the Brachistochrone when the force is central, and proportional to a power of the distance; the speed being also proportional to a power of the distance, that is, being the speed from infinity if the force is attractive, from the centre if it is repulsive.

Here 
$$v^2 = 2(H - V) = \frac{\mu}{r^n},$$

and the central force at distance  $r$  is evidently

$$-\frac{dV}{dr} = -\frac{n\mu}{2r^{n+1}}.$$

Thus (2) becomes 
$$\left(\frac{d\tau}{dx}\right)^2 + \left(\frac{d\tau}{dy}\right)^2 + \left(\frac{d\tau}{dz}\right)^2 = \frac{r^n}{\mu}$$

or, changing to polar co-ordinates,

$$\left(\frac{d\tau}{dr}\right)^2 + \frac{1}{r^2} \left(\frac{d\tau}{d\theta}\right)^2 + \frac{1}{r^2 \sin^2 \theta} \left(\frac{d\tau}{d\phi}\right)^2 = \frac{r^n}{\mu}.$$

It is obvious that we must take 
$$\frac{d\tau}{d\phi} = 0,$$

which shows that the path is in a plane passing through the centre of force. The above equation will then be satisfied by

$$\frac{d\tau}{d\theta} = \alpha, \quad \frac{d\tau}{dr} = \sqrt{\frac{r^n}{\mu} - \frac{\alpha^2}{r^2}}.$$

Hence we have

$$\begin{aligned} \tau &= \alpha\theta + \int dr \sqrt{\frac{r^n}{\mu} - \frac{\alpha^2}{r^2}}, \\ &= \alpha\theta + \frac{2\alpha}{n+2} \left\{ \sqrt{\frac{r^{n+2}}{\mu\alpha^2} - 1} - \cos^{-1} \frac{\sqrt{\mu\alpha}}{r^{\frac{n+2}{2}}} \right\} + C. \end{aligned}$$

And the equation of the brachistochrone is

$$\begin{aligned} \mathfrak{A} &= \theta + \frac{2}{n+2} \left\{ \sqrt{\frac{r^{n+2}}{\mu\alpha^2} - 1} - \cos^{-1} \frac{\sqrt{\mu\alpha}}{r^{\frac{n+2}{2}}} \right\} \\ &+ \frac{2\alpha}{n+2} \left\{ -\frac{\frac{r^{n+2}}{\mu\alpha^2}}{\sqrt{\frac{r^{n+2}}{\mu\alpha^2} - 1}} + \frac{\sqrt{\mu}}{r^{\frac{n+2}{2}}} \frac{1}{\sqrt{1 - \frac{\mu\alpha^2}{r^{n+2}}}} \right\} \\ &= \theta - \frac{2}{n+2} \cos^{-1} \frac{\sqrt{\mu\alpha}}{r^{\frac{n+2}{2}}}; \end{aligned}$$

or

$$r^{\frac{n+2}{2}} = \sqrt{\mu\alpha} \sec \frac{n+2}{2} (\theta - \mathfrak{A}),$$

while the equation of the *free* path is

$$\left(\frac{r}{a}\right)^{\frac{n-2}{2}} = \cos \frac{n-2}{2}(\theta + \beta).$$

The above integration fails in the case of  $n = -2$ ; that is, when the force is repulsive and directly as the distance, the speed vanishing at the centre of force. But in this case

$$\tau = \alpha\theta + \sqrt{\frac{1}{\mu} - \alpha^2} \log Cr,$$

and the equation of the brachistochrone is

$$\mathfrak{A} = \theta - \frac{\alpha}{\sqrt{\frac{1}{\mu} - \alpha^2}} \log Cr,$$

the logarithmic spiral. Eliminating  $r$  between these equations, we see that the time is proportional to the polar angle.

Since a definite form has been assigned to the expression for the speed in this problem, it is obvious that  $H$  is given, and therefore that there is no  $\frac{d\tau}{dH}$ .

The assumption 
$$\frac{d\tau}{d\phi} = 0$$

is easily justified, in the case of any equation of the form

$$\left(\frac{d\tau}{dr}\right)^2 + \frac{1}{r^2} \left(\frac{d\tau}{d\theta}\right)^2 + \frac{1}{r^2 \sin^2 \theta} \left(\frac{d\tau}{d\phi}\right)^2 = F^2,$$

if  $F$  be a function of  $r$  only. For

$$\delta \left(\frac{d\tau}{d\phi}\right) = \frac{d^2\tau}{drd\phi} \delta r + \frac{d^2\tau}{d\theta d\phi} \delta\theta + \frac{d^2\tau}{d\phi^2} \delta\phi.$$

But 
$$\frac{d\tau}{dr} = F^2 \frac{dr}{dt}, \quad \frac{d\tau}{rd\theta} = F^2 \frac{rd\theta}{dt}, \quad \frac{d\tau}{r \sin \theta d\phi} = F^2 \frac{r \sin \theta d\phi}{dt}.$$

Hence 
$$\delta \left(\frac{d\tau}{d\phi}\right) = \frac{\delta t}{F^2} \left\{ \frac{d\tau}{dr} \frac{d^2\tau}{drd\phi} + \frac{1}{r^2} \frac{d\tau}{d\theta} \frac{d^2\tau}{d\theta d\phi} + \frac{1}{r^2 \sin^2 \theta} \frac{d\tau}{d\phi} \frac{d^2\tau}{d\phi^2} \right\} = \frac{\delta t}{F} \left(\frac{dF}{d\phi}\right) = 0.$$

That is, unless  $F$  contains  $\phi$ ,  $\frac{d\tau}{d\phi}$  is necessarily a constant,  $\beta$  suppose.

But, in the present case, if we give this constant any value but zero, we introduce a problem much more general than that proposed, for the expression for the reciprocal of the square of the speed becomes

$$\frac{r^2}{\mu} - \frac{\beta^2}{r^2 \sin^2 \theta}.$$

10. As an example of a tortuous curve we take the following:

*Determine the form of the brachistochrone when the speed at any point of space is proportional to the distance from a given line.*

Taking the line as the axis of  $z$ , our equation obviously becomes

$$\left(\frac{d\tau}{dx}\right)^2 + \left(\frac{d\tau}{dy}\right)^2 + \left(\frac{d\tau}{dz}\right)^2 = \frac{a^2}{x^2 + y^2}.$$

Hence 
$$\frac{d\tau}{dz} = \alpha,$$

and, substituting this, and changing to polar co-ordinates in a plane parallel to  $xy$ ,

$$\left(\frac{d\tau}{dr}\right)^2 + \frac{1}{r^2} \left(\frac{d\tau}{d\theta}\right)^2 = \frac{a^2}{r^2} - \alpha^2.$$

Hence we may take 
$$\frac{d\tau}{d\theta} = \beta,$$

and there remains 
$$\frac{d\tau}{dr} = \frac{1}{r} \sqrt{a^2 - \beta^2 - \alpha^2 r^2}.$$

Integrating, we have

$$\tau = \alpha z + \beta \theta - \sqrt{a^2 - \beta^2} \log \cdot \left[ \frac{\sqrt{a^2 - \beta^2}}{r} + \sqrt{\frac{a^2 - \beta^2}{r^2} - \alpha^2} \right] + \sqrt{a^2 - \beta^2 - \alpha^2 r^2}.$$

By equating to constants the partial differential coefficients of  $\tau$  with respect to  $\alpha$  and  $\beta$ , we obtain the two equations of the brachistochrone

$$\mathfrak{A} = z - \frac{\alpha r^2}{\sqrt{a^2 - \beta^2} + \sqrt{a^2 - \beta^2 - \alpha^2 r^2}},$$

and 
$$\mathfrak{B} = \theta + \frac{\beta}{\sqrt{a^2 - \beta^2}} \log \cdot \left[ \frac{\sqrt{a^2 - \beta^2}}{r} + \sqrt{\frac{a^2 - \beta^2}{r^2} - \alpha^2} \right].$$

The former of these is the equation of a sphere, as may be seen at once by putting it in the form

$$\alpha(z - \mathfrak{A}) = \sqrt{a^2 - \beta^2} - \sqrt{a^2 - \beta^2 - \alpha^2 r^2}.$$

The remaining equation, by altering the value of  $\mathfrak{B}$ , may be reduced to the form

$$2 \frac{\sqrt{a^2 - \beta^2}}{\alpha} = r \left( \epsilon^{\frac{\sqrt{a^2 - \beta^2}}{\beta}(\theta - \mathfrak{B})} + \epsilon^{-\frac{\sqrt{a^2 - \beta^2}}{\beta}(\theta - \mathfrak{B})} \right)$$

which is at once recognised as a cylinder, whose base is one of Cotes' Spirals.

Also, if we remark that, by (1),

$$r \frac{d\theta}{dt} = v^2 \frac{d\tau}{rd\theta} = \frac{r^2}{a^2} \cdot \frac{\beta}{r} = \frac{\beta v}{a}$$

we see that 
$$\cos \psi = \frac{r \frac{d\theta}{dt}}{v} = \frac{\beta}{a} = \text{const.}$$

where  $\psi$  is the inclination of the element  $r\delta\theta$  to the corresponding element  $\delta s$  of the brachistochrone. That is, the brachistochrone cuts all circles on the above sphere, whose planes are parallel to  $xy$ , at a constant angle. (*Loxodrome.*)

11. It is easily seen that  $\tau = C$

is the equation of an *Isochronous* surface.

Also, since 
$$\frac{\left(\frac{d\tau}{dx}\right)}{\frac{d\tau}{dt}} = \frac{\left(\frac{d\tau}{dy}\right)}{\frac{d\tau}{dt}} = \frac{\left(\frac{d\tau}{dz}\right)}{\frac{d\tau}{dt}},$$

the brachistochrone cuts all such surfaces at right angles.

And the normal distance between two consecutive isochronous surfaces is proportional to the speed in the brachistochrone of which it forms an element. For, of course,

$$\delta s = r\delta\tau.$$

12. Generally, putting 
$$\mathfrak{T} = \left(\frac{d\tau}{dx}\right)^2 + \left(\frac{d\tau}{dy}\right)^2 + \left(\frac{d\tau}{dz}\right)^2 = \frac{1}{2(H-V)} \dots\dots\dots(7),$$

we have 
$$2(H-V) = \frac{1}{\mathfrak{T}},$$

and 
$$X = -\left(\frac{dV}{dx}\right) = -\frac{1}{2\mathfrak{T}^2} \frac{d\mathfrak{T}}{dx} \dots\dots\dots(8),$$

with similar expressions for  $Y$  and  $Z$ .

Also, by (1), we have 
$$\left. \begin{aligned} \frac{d\tau}{dx} &= \mathfrak{T} \frac{dx}{dt}, \text{ \&c.} \\ \frac{d\tau}{dH} &= -\int \mathfrak{T} dt \end{aligned} \right\} \dots\dots\dots(9).$$

Hence 
$$\begin{aligned} \frac{d^2x}{dt^2} &= \frac{d}{dt} \left( \frac{1}{\mathfrak{T}} \frac{d\tau}{dx} \right) \\ &= \frac{1}{\mathfrak{T}} \frac{d}{dt} \left( \frac{d\tau}{dx} \right) - \frac{1}{\mathfrak{T}^2} \frac{d\tau}{dx} \frac{d\mathfrak{T}}{dt} \dots\dots\dots(10). \end{aligned}$$

But 
$$\begin{aligned} \frac{d}{dt} \left( \frac{d\tau}{dx} \right) &= \frac{d^2\tau}{dx^2} \frac{dx}{dt} + \frac{d^2\tau}{dy dx} \frac{dy}{dt} + \frac{d^2\tau}{dz dx} \frac{dz}{dt} \\ &= \frac{1}{\mathfrak{T}} \left\{ \frac{d^2\tau}{dx^2} \frac{d\tau}{dx} + \frac{d^2\tau}{dy dx} \frac{d\tau}{dy} + \frac{d^2\tau}{dz dx} \frac{d\tau}{dz} \right\} = \frac{1}{2\mathfrak{T}} \frac{d\mathfrak{T}}{dx} \dots\dots\dots(11), \end{aligned}$$

which is the ordinary form of the equation of the brachistochrone, (A) in § 4.



Also

$$\begin{aligned} \frac{d\mathfrak{T}}{dt} &= 2 \left\{ \frac{d\tau}{dx} \frac{d}{dt} \left( \frac{d\tau}{dx} \right) + \frac{d\tau}{dy} \frac{d}{dt} \left( \frac{d\tau}{dy} \right) + \frac{d\tau}{dz} \frac{d}{dt} \left( \frac{d\tau}{dz} \right) \right\} \\ &= \frac{1}{\mathfrak{T}} \left\{ \frac{d\tau}{dx} \frac{d\mathfrak{T}}{dx} + \frac{d\tau}{dy} \frac{d\mathfrak{T}}{dy} + \frac{d\tau}{dz} \frac{d\mathfrak{T}}{dz} \right\} \dots\dots\dots(12). \end{aligned}$$

The above value of  $\frac{d^2x}{dt^2}$  becomes therefore

$$\frac{d^2x}{dt^2} = \frac{1}{2\mathfrak{T}^2} \frac{d\mathfrak{T}}{dx} - \frac{1}{\mathfrak{T}^3} \frac{d\tau}{dx} \left\{ \frac{d\tau}{dx} \frac{d\mathfrak{T}}{dx} + \frac{d\tau}{dy} \frac{d\mathfrak{T}}{dy} + \frac{d\tau}{dz} \frac{d\mathfrak{T}}{dz} \right\} \dots\dots\dots(13),$$

which (8) reduces to the form

$$\frac{d^2x}{dt^2} = -X + \frac{2}{\mathfrak{T}} \frac{d\tau}{dx} \left\{ X \frac{d\tau}{dx} + Y \frac{d\tau}{dy} + Z \frac{d\tau}{dz} \right\} \dots\dots\dots(14).$$

And we have, of course, similar expressions for  $\frac{d^2y}{dt^2}$  and  $\frac{d^2z}{dt^2}$ .

13. We may thus easily prove the fundamental property of brachistochrones given in most treatises on dynamics.

*The pressure on the curve, due to the motion, is equal to that due to the impressed forces.*

For (14) may be written

$$\begin{aligned} \frac{d^2x}{dt^2} &= -X + 2 \frac{dx}{dt} \frac{1}{\mathfrak{T}} \left\{ X \frac{dx}{dt} + Y \frac{dy}{dt} + Z \frac{dz}{dt} \right\} \\ &= -X + 2 \frac{dx}{ds} \left\{ X \frac{dx}{ds} + Y \frac{dy}{ds} + Z \frac{dz}{ds} \right\} \\ &= X - 2 \left\{ X - \frac{dx}{ds} \left( X \frac{dx}{ds} + Y \frac{dy}{ds} + Z \frac{dz}{ds} \right) \right\}. \end{aligned}$$

Now  $X \frac{dx}{ds} + Y \frac{dy}{ds} + Z \frac{dz}{ds}$  is the component of the impressed forces along  $ds$ . Hence

$$\begin{aligned} X - \frac{dx}{ds} \left( X \frac{dx}{ds} + Y \frac{dy}{ds} + Z \frac{dz}{ds} \right), \\ Y - \frac{dy}{ds} \left( X \frac{dx}{ds} + Y \frac{dy}{ds} + Z \frac{dz}{ds} \right), \quad Z - \frac{dz}{ds} \left( X \frac{dx}{ds} + Y \frac{dy}{ds} + Z \frac{dz}{ds} \right), \end{aligned}$$

are the rectangular components of the component of the impressed force perpendicular to the path.

But, if  $R$  be the force of constraint,  $\lambda, \mu, \nu$  its direction-cosines, we have by ordinary kinetics

$$\frac{d^2x}{dt^2} = X - R\lambda, \text{ \&c.}$$

Hence 
$$R\lambda = 2 \left\{ X - \frac{dx}{ds} \left( X \frac{dx}{ds} + Y \frac{dy}{ds} + Z \frac{dz}{ds} \right) \right\}, \text{ \&c., \&c.,}$$

and therefore the whole pressure is *double* that due to the impressed forces.

From the above follows also the well-known theorem, that *the osculating plane of the brachistochrone contains, at each point, the resultant of the impressed forces.* For it has been shown that this resultant coincides in direction with the centrifugal force, and the latter of course lies in the osculating plane.

14. Another, and perhaps simpler proof of the theorem above is furnished directly by (10). Thus, squaring and adding the three equations of that form, after substituting in them from (11), we have

$$\begin{aligned} \left( \frac{d^2x}{dt^2} \right)^2 + \left( \frac{d^2y}{dt^2} \right)^2 + \left( \frac{d^2z}{dt^2} \right)^2 &= \frac{1}{4\mathcal{T}^4} \left\{ \left( \frac{d\mathcal{T}}{dx} \right)^2 + \left( \frac{d\mathcal{T}}{dy} \right)^2 + \left( \frac{d\mathcal{T}}{dz} \right)^2 \right\} \\ &\quad - \frac{1}{\mathcal{T}^4} \frac{d\mathcal{T}}{dt} \left\{ \frac{d\tau}{dx} \frac{d\mathcal{T}}{dx} + \frac{d\tau}{dy} \frac{d\mathcal{T}}{dy} + \frac{d\tau}{dz} \frac{d\mathcal{T}}{dz} \right\} \\ &\quad + \frac{1}{\mathcal{T}^4} \left( \frac{d\mathcal{T}}{dt} \right)^2 \left\{ \left( \frac{d\tau}{dx} \right)^2 + \left( \frac{d\tau}{dy} \right)^2 + \left( \frac{d\tau}{dz} \right)^2 \right\} \\ &= \frac{1}{4\mathcal{T}^4} \left\{ \left( \frac{d\mathcal{T}}{dx} \right)^2 + \left( \frac{d\mathcal{T}}{dy} \right)^2 + \left( \frac{d\mathcal{T}}{dz} \right)^2 \right\} - \frac{1}{\mathcal{T}^4} \frac{d\mathcal{T}}{dt} \left( \mathcal{T} \frac{d\mathcal{T}}{dt} \right) + \frac{1}{\mathcal{T}^4} \left( \frac{d\mathcal{T}}{dt} \right)^2 (\mathcal{T}) \end{aligned}$$

$$\text{[by (12) and (7)]} \quad = \frac{1}{4\mathcal{T}^4} \left\{ \left( \frac{d\mathcal{T}}{dx} \right)^2 + \left( \frac{d\mathcal{T}}{dy} \right)^2 + \left( \frac{d\mathcal{T}}{dz} \right)^2 \right\} = X^2 + Y^2 + Z^2, \text{ by (8).}$$

Hence *the whole acceleration is equal to the resultant of the impressed forces*; and therefore the component of the acceleration, normal to the curve, must be equal to that of the resultant of the impressed forces; from which the theorem follows at once if we can show independently that the resultant of the impressed forces lies in the osculating plane. This is easily done as follows. We have

$$\delta x = \frac{\delta t}{\mathcal{T}} \frac{d\tau}{dx}, \text{ \&c., by (9).}$$

$$\text{Hence} \quad \delta^2 x = \frac{\delta t}{\mathcal{T}} \delta \left( \frac{d\tau}{dx} \right) - \frac{\delta x}{\mathcal{T}} \delta \mathcal{T}, \text{ \&c.}$$

Now, by (8) and (11),  $\delta \left( \frac{d\tau}{dx} \right)$  &c., are proportional to the direction-cosines of the resultant force, which therefore lies in the common plane of two consecutive elements of the curve.

15. The equation of the surfaces which are orthogonal to the path is

$$\tau = C;$$

$$\text{and that of equipotential surfaces} \quad V = C_1.$$

That these may coincide we must have

$$\tau = \phi(V),$$

where  $\phi$  is any function whatever.

Hence 
$$\{\phi'(V)\}^2 \left\{ \left(\frac{dV}{dx}\right)^2 + \left(\frac{dV}{dy}\right)^2 + \left(\frac{dV}{dz}\right)^2 \right\} = \frac{1}{2(H-V)}.$$

If we write 
$$\mathcal{V} = \int \sqrt{2(H-V)} \phi'(V) dV = \psi(V) \dots\dots\dots(15),$$

this becomes 
$$\left(\frac{d\mathcal{V}}{dx}\right)^2 + \left(\frac{d\mathcal{V}}{dy}\right)^2 + \left(\frac{d\mathcal{V}}{dz}\right)^2 = 1. \dots\dots\dots(16).$$

A complete primitive of this equation is, of course.

$$\mathcal{V} = lx + my + nz - p,$$

where  $p$  is any function of  $l, m, n$ , and

$$l^2 + m^2 + n^2 = 1.$$

The general primitive, equated to a constant, is therefore obviously the equation of a series of surfaces such that the normal distance between any two consecutive members of the series is everywhere the same. It is evident from (15) that the surfaces thus found are identical with the isochronous and equipotential surfaces, when these coincide. The equations of their orthogonal trajectory, that is, of the free path which is also a brachistochrone, are therefore,

$$\frac{\delta x}{\left(\frac{d\mathcal{V}}{dx}\right)} = \frac{\delta y}{\left(\frac{d\mathcal{V}}{dy}\right)} = \frac{\delta z}{\left(\frac{d\mathcal{V}}{dz}\right)} = \frac{\left(\frac{d\mathcal{V}}{dx}\right) \delta x + \left(\frac{d\mathcal{V}}{dy}\right) \delta y + \left(\frac{d\mathcal{V}}{dz}\right) \delta z}{\left(\frac{d\mathcal{V}}{dx}\right)^2 + \left(\frac{d\mathcal{V}}{dy}\right)^2 + \left(\frac{d\mathcal{V}}{dz}\right)^2} = \delta\mathcal{V} = \delta C \dots\dots\dots(17).$$

Hence 
$$\delta x = \delta C \left(\frac{d\mathcal{V}}{dx}\right), \text{ \&c.,}$$

and, therefore,

$$\delta^2 x = \delta C \left\{ \left(\frac{d^2\mathcal{V}}{dx^2}\right) \delta x + \left(\frac{d^2\mathcal{V}}{dxdy}\right) \delta y + \left(\frac{d^2\mathcal{V}}{dxdz}\right) \delta z \right\} + \delta^2 C \left(\frac{d\mathcal{V}}{dx}\right).$$

But, substituting the values of  $\delta x$ , &c., from (17), this becomes

$$\delta^2 x = (\delta C)^2 \left\{ \left(\frac{d\mathcal{V}}{dx}\right) \left(\frac{d^2\mathcal{V}}{dx^2}\right) + \left(\frac{d\mathcal{V}}{dy}\right) \left(\frac{d^2\mathcal{V}}{dxdy}\right) + \left(\frac{d\mathcal{V}}{dz}\right) \left(\frac{d^2\mathcal{V}}{dxdz}\right) \right\} + \delta^2 C \left(\frac{d\mathcal{V}}{dx}\right),$$

and the first part vanishes, by (16).

Hence 
$$\frac{\delta^2 x}{\delta x} = \frac{\delta^2 y}{\delta y} = \frac{\delta^2 z}{\delta z} = \frac{\delta^2 C}{\delta C},$$

which show that when the path is simultaneously a free path and a brachistochrone, it is necessarily rectilinear.

This might have been inferred at once, from the theorem of § 13, which shows that if the free path be a brachistochrone, there can be no pressure due to the motion, *i.e.*, no curvature. But the above investigation is given as containing curious additional information. It shows, for instance, that if the force be the same at all points of each of a series of equipotential surfaces, the lines of force are rectilinear. Also, that if the flux of heat be constant per unit of area over each one of a series of isothermal surfaces, though not necessarily the same for all, the propagation of heat takes place in straight lines. And, as particular cases of these theorems, if the force or the flux of heat be the same throughout a given space, the attraction, or the flux, therein takes place in parallel lines.

16. Hamilton's equation for the determination of the Characteristic Function ( $A$ ) in the case of the free motion of a single particle is

$$\left(\frac{dA}{dx}\right)^2 + \left(\frac{dA}{dy}\right)^2 + \left(\frac{dA}{dz}\right)^2 = 2(H - V) \dots\dots\dots(18).$$

The comparison of this with (2) suggests a useful transformation. Introducing in that equation a factor  $\theta^2$ , an undetermined function of  $x, y, z$ , we have

$$\left(\theta \frac{d\tau}{dx}\right)^2 + \left(\theta \frac{d\tau}{dy}\right)^2 + \left(\theta \frac{d\tau}{dz}\right)^2 = \frac{\theta^2}{2(H - V)} \dots\dots\dots(19).$$

If we make  $\theta = \phi'(\tau) \dots\dots\dots(20),$

and  $\frac{\theta^2}{2(H - V)} = 2(H_1 - V_1) \dots\dots\dots(21),$

(19) becomes  $\left(\frac{d\phi(\tau)}{dx}\right)^2 + \left(\frac{d\phi(\tau)}{dy}\right)^2 + \left(\frac{d\phi(\tau)}{dz}\right)^2 = 2(H_1 - V_1) \dots\dots\dots(22).$

Here it is obvious, by (18), that  $\phi(\tau)$  is the action in a *free* path coinciding with the brachistochrone, and that  $2(H_1 - V_1)$  is the square of the speed in this path.

Hence the curious result that, *if  $\tau$  be the time through any arc of a given brachistochrone, the same path will be described freely under the action of forces whose potential is  $V_1$ , where*

$$2(H_1 - V_1) = \frac{\{\phi'(\tau)\}^2}{2(H - V)},$$

$\phi'$  being any function whatever; and  $\phi(\tau)$  representing the action in the free path.

17. The simplest supposition we can make is that  $\phi'(\tau)$  is constant. In this case the speed in the free path is inversely proportional to that in the brachistochrone at the same point; and the action in the one is proportional to the time in the other. In fact, as Professor W. Thomson has pointed out to me, in this case the investigation may be made with extreme simplicity, thus—

In the brachistochrone we have

$$\int \frac{ds}{v} \text{ a minimum.}$$

Putting  $v = \frac{1}{\nu}$ , and considering  $\nu$  as the speed in the same path due to another (easily determinable) potential; we must have

$$\int \nu ds \text{ a minimum.}$$

This is the ordinary condition of *Least Action*, and belongs, therefore, to a free path.

Hence, since the cycloid is the brachistochrone for gravity, and since in it  $v^2 = 2gy$ , it will be a free path if  $\nu^2 = \frac{1}{2gy}$ , that is for a system of force where the potential is found from

$$H_1 - V_1 = \frac{1}{4gy}.$$

This gives 
$$-\frac{dV_1}{dx} = 0, \quad -\frac{dV_1}{dy} = -\frac{1}{4gy^2}.$$

In other words, a cycloid may be described freely under the action of a force towards, and inversely as the square of the distance from, the base; and the speed at any point will be the reciprocal of that in the same cycloid when it is the common brachistochrone.

This result is easily verified by a direct process.

18. But we have, by § 16, an infinite number of other systems of forces under which this cycloid will be described freely.

For by § 8 we have, putting  $a=0$ , since the base is now the axis of  $x$ ,

$$\begin{aligned} \sqrt{2g} \tau &= \frac{x}{\sqrt{b}} + \int dy \sqrt{\frac{1}{y} - \frac{1}{b}} \\ &= \frac{x}{\sqrt{b}} - \sqrt{b} \cos^{-1} \sqrt{\frac{y}{b}} + \sqrt{\frac{y}{b}} \sqrt{b-y} + C. \end{aligned}$$

Hence, whatever be  $\phi'$ , the cycloid is a free path for the system

$$v^2 = 2(H_1 - V_1) = \frac{\left\{ \phi' \left( \frac{x}{\sqrt{b}} - \sqrt{b} \cos^{-1} \sqrt{\frac{y}{b}} + \sqrt{\frac{y}{b}} \sqrt{b-y} + C \right) \right\}^2}{2gy}.$$

19. The converse of the proposition in § 16 is also curious. Taking Hamilton's equation (18), we have,

$$\{\phi'(A)\}^2 \left\{ \left( \frac{dA}{dx} \right)^2 + \left( \frac{dA}{dy} \right)^2 + \left( \frac{dA}{dz} \right)^2 \right\} = 2(H - V) \{\phi'(A)\}^2 \dots \dots \dots (23).$$

Comparing this with (2), we see that  $\tau = \phi(A)$  is the brachistochronic expression for the time in a path which is a free path for potential  $V$ . The requisite potential is now found from

$$\frac{1}{2(H_1 - V_1)} = 2(H - V) \{\phi'(A)\}^2 \dots \dots \dots (24).$$

Hence, if  $A$  be the action in a given free path, the same path will be a brachistochrone for forces whose potential is  $V_1$ , determined by (24),  $V$  being the potential in the free path.

Thus, the parabola  $(x - \mathfrak{A})^2 = 4a(y - a)$

is the free path for  $v^2 = 2gy$ . And the action is given by

$$\frac{1}{\sqrt{2g}} A = x \sqrt{a} + \frac{2}{3}(y - a)^{3/2}.$$

Hence this parabola is the brachistochrone for

$$2(H_1 - V_1) = \frac{1}{2gy \{\phi'(A)\}^2}.$$

In the simplest case  $\phi'(A) = 1$ , and we have

$$-\frac{dV_1}{dx} = 0, \quad -\frac{dV_1}{dy} = -\frac{1}{4gy^2}.$$

Hence, by § 17, the parabola is a brachistochrone when a cycloid is the free path.

20. Again, if  $v^2 = 2\left(\frac{\mu}{r} - H\right) \dots \dots \dots (25),$

where  $H$  and  $\mu$  are essentially positive, the free path is an ellipse of which the origin (the centre of force) is a focus.

This ellipse is the brachistochrone for the potential  $V_1$ , and whole energy  $H_1$ , where

$$\frac{C}{2(H_1 - V_1)} = 2\left(\frac{\mu}{r} - H\right),$$

or 
$$V_1 = H_1 - \frac{Cr}{4(\mu - Hr)}.$$

This corresponds to a central force

$$\begin{aligned} -\frac{dV_1}{dr} &= \frac{C}{4(\mu - Hr)} + \frac{CHr}{4(\mu - Hr)^2} \\ &= \frac{C\mu}{4(\mu - Hr)^2}. \end{aligned}$$

The speed at any point is  $\sqrt{\frac{Cr}{2(\mu - Hr)}}$ .

In the ellipse, we know by ordinary kinetics that

$$v^2 = \mu \left( \frac{2}{r} - \frac{1}{a} \right).$$

Comparing this with the above formula (25) we have

$$\frac{\mu}{H} = 2a.$$

Hence the speed in the free ellipse is

$$v = \sqrt{\frac{\mu}{a}} \sqrt{\frac{2a-r}{r}} \dots \dots \dots (26).$$

That in the same ellipse, when it is a brachistochrone, is, as above,

$$v_1 = \sqrt{\frac{Cr}{2(\mu - Hr)}} = \sqrt{\frac{Ca}{\mu}} \sqrt{\frac{r}{2a-r}}.$$

But if we refer it to the other focus of the ellipse we have

$$r_1 = 2a - r.$$

Hence

$$v_1 = \sqrt{\frac{Ca}{\mu}} \sqrt{\frac{2a-r_1}{r_1}} \dots \dots \dots (27).$$

Comparing (26) and (27), we have the singular result that a planet moving freely about a centre of force in the focus of its elliptic orbit is describing a brachistochrone (for the same law of speed as regards position) about the other focus. The reason of this remarkable property, as well as of the connected one that while the time in an elliptic orbit is (of course) measured by the area described about one focus, the action is measured by that described about the other\*, is easily traced to the fact that the rectangle under the perpendiculars from the foci on any tangent is constant.

21. It follows from Hamilton's investigations, that in the free ellipse we have

$$A = \int \frac{2 \left( \frac{\mu}{r} - H \right) dr}{\sqrt{2 \left( \frac{\mu}{r} - H \right) - \frac{\alpha^2}{r^2}}},$$

where  $\alpha$  depends upon the excentricity of the ellipse by the formula

$$\alpha^2 = \frac{\mu^2}{2H} (1 - e^2).$$

\* Tait, Proc. R.S.E., March, 1865, or Tait and Steele's *Dynamics of a Particle* (2nd edition), § 258.

The theorem may therefore be generalized as follows:—The free ellipse will be a brachistochrone, if the speed be given by

$$v^2 = 2(H_1 - V_1) = \frac{1}{2\left(\frac{\mu}{r} - H\right)\{\phi'(A)\}^2},$$

where  $\phi'$  is any function, and  $A$  is the integral last written. By differentiation with respect to  $r$ , we get the law of central force requisite.

But results of this nature may be deduced to any desired extent, without more trouble than the requisite integrations involve.

22. The examples immediately preceding are but particular cases of the following general theorem, which is easily seen to be involved in the results of §§ 16, 19. *If we have two curves, P and Q, of which P is a free path, and Q a brachistochrone, for a given conservative system of forces; P will be a brachistochrone for a system of forces for which Q is a free path:—and the action and time in any arc of either, when it is described freely, are functions of the time and action respectively, in the same arc, when it is a brachistochrone.*

23. It is easy to see, that there exists a very singular analogy between the processes we have just given, and those suggested by certain problems in optics.

Assuming, for an instant, the exploded corpuscular theory of Light, Varying Action is at once applicable to the determination of the path of a corpuscle. On the other hand, if we assume, as our fundamental hypothesis, that light takes the least possible time to pass from one point of its path to another, the foregoing investigations would be directly applicable to find the path in a medium whose refractive index (on which the speed depends), at any point, is a given function of the co-ordinates; in other words, in a heterogeneous singly refracting medium.

In the beautiful investigations of Hamilton, on the *Theory of Systems of Rays* (*Trans. R.I.A.*, 1824—32), the path of a ray is assumed to be a straight line in any one medium. Here the speed depends only upon the *direction* of the ray, as in homogeneous doubly refracting media, and the problem has no analogy with the conservative case which is treated above.

24. As an instance of an optical problem I take the following, due I believe to Maxwell\*. *If the refractive index of a medium be such a function of the distance from a given point that the path of any one ray is a circle, the path of every other ray is a circle; and all rays diverging from any one point converge accurately in another.* Or, in another form, find the relation between the speed and the distance from the centre of force that the brachistochrone may always be a circle.

\* *Cambridge and Dublin Math. Journal*, ix., p. 9.



The symmetry shows that our investigations need involve only two dimensions. Taking the centre of force as pole, the equation of a circle is

$$r^2 + 2ar \cos(\theta - \mathfrak{A}) = \rho^2 - a^2, = b^2 \text{ suppose.}$$

Hence 
$$\mathfrak{A} = \theta - \cos^{-1} \frac{b^2 - r^2}{2ar}.$$

This is obviously the equation before written (3), in the form

$$\frac{d\tau}{d\alpha} = \mathfrak{A}.$$

Hence 
$$\tau = \alpha\theta - \int d\alpha \cos^{-1} \frac{b^2 - r^2}{2ar}.$$

But, if  $v$  be the speed (the reciprocal of the refractive index in the optical problem),

$$\left(\frac{d\tau}{dr}\right)^2 + \frac{1}{r^2} \left(\frac{d\tau}{d\theta}\right)^2 = \frac{1}{v^2}.$$

Hence 
$$\frac{d\tau}{dr} = \sqrt{\frac{1}{v^2} - \frac{\alpha^2}{r^2}} = -\frac{d}{dr} \int d\alpha \cos^{-1} \frac{b^2 - r^2}{2ar} = -\int d\alpha \frac{b^2 + r^2}{r \sqrt{\{4a^2r^2 - (b^2 - r^2)^2\}}}.$$

But  $v$  is not a function of  $\alpha$ , so that we get by differentiation with respect to that quantity

$$\frac{\frac{\alpha}{r^2}}{\sqrt{\frac{1}{v^2} - \frac{\alpha^2}{r^2}}} = \frac{b^2 + r^2}{r \sqrt{\{4a^2r^2 - (b^2 - r^2)^2\}}}.$$

This is easily reduced to 
$$v^2\alpha^2 = \frac{(b^2 + r^2)^2}{4(a^2 + b^2)} = \frac{(b^2 + r^2)^2}{4\rho^2}.$$

The condition, that  $v$  is a function of  $r$  and absolute constants only, thus leads at once to two conclusions:  $b$  is an absolute constant; and so is  $2\rho\alpha$ , for which we may write  $c$ .  $\alpha$  is therefore inversely as the diameter of the circle; and

$$v = \frac{b^2 + r^2}{c}.$$

From the form of the equation of the path it is obvious that  $-b^2$  is the rectangle under the segments of any chord drawn through the centre of force.

Hence, in the optical problem, if a ray leave, in any direction, a point distant  $r$  from the origin, it will pass through another point in the prolongation of  $r$ , distant  $\frac{b^2}{r}$  from the origin; and, in the kinetic problem, there is an infinite number of brachistochrones (circles all, and the time being the same for all) when two points thus related are taken as the initial and final points.

25. Such examples might be multiplied indefinitely. For instance, if the refractive index of a medium be inversely proportional to the square root of the distance from a given point, the path is a parabola about the point as focus; that every ray may be a cardioid whose cusp is at the point, the square of the refractive index must be inversely as the cube of the distance: and so on.

26. The processes of § 4 may of course be applied to innumerable problems besides the determination of the form and properties of brachistochrones, but I shall content myself with an example or two. Thus, if we take

$$\Phi = \int f(v) ds$$

as the characteristic function, we have

$$\frac{d\Phi}{dx} = \frac{f(v)}{v} \frac{dx}{dt}, \text{ \&c., and } \frac{d\Phi}{dH} = \int f'(v) dt.$$

Of this, besides the cases  $f(v) = v$ , and  $f(v) = \frac{1}{v}$ , which we have already considered, the most curious is that where

$$f(v) = \frac{v^2}{2};$$

that is, when *the space average of the kinetic energy is a minimum*. In this case,

$$\left(\frac{d\Phi}{dx}\right)^2 + \left(\frac{d\Phi}{dy}\right)^2 + \left(\frac{d\Phi}{dz}\right)^2 = \frac{v^4}{4} = (H - V)^2,$$

and

$$\frac{d\Phi}{dH} = s.$$

Again, if we take

$$\Phi = \int F(x, y, z) f(v) ds$$

$$\frac{d\Phi}{dx} = \frac{Ff}{v} \frac{dx}{dt}, \text{ \&c., and } \frac{d\Phi}{dH} = \int Ff'(v) dt.$$

Hence, if

$$F(x, y, z) = \frac{\text{Constant}}{f'(v)},$$

we have

$$\frac{d\Phi}{dH} = Ct,$$

so that there is an infinite number of values of the characteristic function, besides that of Hamilton, which give the time through any arc of the orbit by their differential coefficients with respect to  $H$ .

27. Enough of this; I conclude with the remark that various investigations in

Statics supply us with excellent examples in our subject\*. Take the common catenary, for instance, its equation is found by the conditions

$$\int y ds = \text{minimum, and } \int ds = \text{constant,}$$

the axis of  $y$  being directed vertically upwards.

This gives 
$$\delta \int (y + a) ds = 0.$$

Hence the catenary is the free path of a particle whose speed is given by

$$v = C(y + a);$$

that is, if the force be in the direction of, and proportional to, the ordinate, and repulsive from the axis of  $x$ . In the same way we see that the catenary is the brachistochrone if the speed be inversely as the distance from the axis; that is, if the force be attractive, and inversely as the cube of the distance from the axis.

\* Compare Thomson and Tait's *Natural Philosophy*, §§ 581, 582.

## X.

## NOTE ON THE REALITY OF THE ROOTS OF THE SYMBOLICAL CUBIC WHICH EXPRESSES THE PROPERTIES OF A SELF-CONJUGATE LINEAR AND VECTOR FUNCTION.

[*Proceedings of the Royal Society of Edinburgh, February 18, 1867.*]

HAMILTON has shown that if  $\phi\rho = \Sigma\alpha S\beta\rho + A\rho$ ,

where  $\alpha$  and  $\beta$  are given vectors, and  $A$  a given scalar, we have

$$(\phi^3 - m_2\phi^2 + m_1\phi - m)\rho = 0,$$

where  $m, m_1, m_2$  are scalars depending only on  $\phi$ .

When the function  $\phi$  is its own conjugate, i.e. when

$$S\rho\phi\sigma = S\sigma\phi\rho,$$

$\rho$  and  $\sigma$  being any vectors whatever, the vectors for which

$$(\phi - g)\rho = 0, \text{ or } \phi\rho \parallel \rho, \text{ or } V\rho\phi\rho = 0,$$

form in general a real and definite rectangular system. This, of course, may in particular cases degrade into one definite vector, and any pair of others perpendicular to it; and cases may occur in which the equation is satisfied for every vector.

Suppose the roots of  $m_g = m + m_1g + m_2g^2 + g^3 = 0$  to be real and different, then

$$\left. \begin{aligned} \phi\rho_1 &= g_1\rho_1 \\ \phi\rho_2 &= g_2\rho_2 \\ \phi\rho_3 &= g_3\rho_3 \end{aligned} \right\} \text{ where } \rho_1, \rho_2, \rho_3 \text{ are definite vectors.}$$

Hence 
$$g_1 g_2 S \rho_1 \rho_2 = S \phi \rho_1 \phi \rho_2$$

$$= S \rho_1 \phi^2 \rho_2, \text{ or } = S \rho_2 \phi^2 \rho_1,$$

because  $\phi$  is its own conjugate.

But 
$$\phi^2 \rho_2 = g_2^2 \rho_2,$$

$$\phi^2 \rho_1 = g_1^2 \rho_1,$$

and therefore 
$$g_1 g_2 S \rho_1 \rho_2 = g_2^2 S \rho_1 \rho_2 = g_1^2 S \rho_1 \rho_2;$$

which, as  $g_1$  and  $g_2$  are by hypothesis different, requires

$$S \rho_1 \rho_2 = 0.$$

Similarly 
$$S \rho_2 \rho_3 = 0, \quad S \rho_3 \rho_1 = 0.$$

If two roots be equal, as  $g_2, g_3$ , we still have, by the above proof,  $S \rho_1 \rho_2 = 0$ , and  $S \rho_1 \rho_3 = 0$ . But there is nothing farther to determine  $\rho_2$  and  $\rho_3$ , which are therefore *any* vectors perpendicular to  $\rho_1$ .

If all three roots be equal, *every* real vector satisfies the equation

$$(\phi - g) \rho = 0.$$

Next, as to the *reality* of the three roots when the function is self-conjugate.

Suppose  $g_2 + h_2 \sqrt{-1}$  to be a root, and let  $\rho_2 + \sigma_2 \sqrt{-1}$  be the corresponding value of  $\rho$ , where  $g_2$  and  $h_2$  are real numbers,  $\rho_2$  and  $\sigma_2$  real vectors, and  $\sqrt{-1}$  the old imaginary of algebra.

Then 
$$\phi(\rho_2 + \sigma_2 \sqrt{-1}) = (g_2 + h_2 \sqrt{-1})(\rho_2 + \sigma_2 \sqrt{-1}),$$

and this divides itself, as in algebra, into the two equations

$$\phi \rho_2 = g_2 \rho_2 - h_2 \sigma_2,$$

$$\phi \sigma_2 = h_2 \rho_2 + g_2 \sigma_2.$$

Operating on these by  $S \sigma_2, S \rho_2$  respectively, and subtracting the results, remembering our condition as to the nature of  $\phi$

$$S \sigma_2 \phi \rho_2 = S \rho_2 \phi \sigma_2,$$

we have

$$h_2 (\sigma_2^2 + \rho_2^2) = 0.$$

But, as  $\sigma_2$  and  $\rho_2$  are both real vectors, the sum of their squares cannot vanish. Hence  $h_2$  vanishes, and with it the impossible part of the root.

## XI.

## NOTE ON A CELEBRATED GEOMETRICAL PROBLEM.

[*Proceedings of the Royal Society of Edinburgh, April 29, 1867.*]

THE following problem, originally proposed by Fermat to Torricelli, *To find the point the sum of whose distances from three given points is the least possible*, seems to have given considerable trouble to the older mathematicians, and even in modern times (see *Gregory's Examples*, p. 126) to have been solved in a very tedious manner. Simpler solutions have since been given (e.g. *Cambridge and Dublin Mathematical Journal*, VIII. p. 92), but none, to my knowledge, so direct as that indicated by Quaternions. The object of this note is to show the simplicity of the quaternion method.

If  $\alpha$ ,  $\beta$  be the vectors of two of the given points, the origin being the third, and if  $\rho$  be the vector of the required point, we must have (by the conditions of the problem)

$$T\rho + T(\alpha - \rho) + T(\beta - \rho) \text{ a minimum.}$$

Hence

$$S[U\rho - U(\alpha - \rho) - U(\beta - \rho)] d\rho = 0,$$

for all values of  $Ud\rho$ . Hence the versor sum in square brackets must vanish identically. The immediate interpretation is, that *lines parallel to  $\rho$ ,  $\rho - \alpha$ ,  $\rho - \beta$ , form an equilateral triangle*. The required point is therefore in the same plane as the three given points; and their distances, two and two, subtend equal angles at it, which is the well-known solution.

Equally simple is the quaternion solution of the same problem if more points than three be given. Let their vectors, to any origin, be  $\alpha$ ,  $\beta$ ,  $\gamma$ , &c., and let  $\rho$  be the vector of the sought point. We have

$$\Sigma T(\alpha - \rho) = \text{minimum,}$$

from which, as above,

$$\Sigma U(\alpha - \rho) = 0 \dots\dots\dots(1).$$

Hence, *if unit forces act at the required point, in the lines joining it with the given points, these forces are in equilibrium.* Or, in another form, a *closed equilateral gauche polygon may be drawn whose sides are parallel to the lines joining the sought point with the given ones.* This opens up some very curious geometrical speculations, which I have not time to pursue.

That there is but one point whose vector satisfies equation (1) may easily be proved by quaternions, but even more easily by the following reasoning. Consider the system of unit-forces, just mentioned, at any *two* points, one of which satisfies the problem. It is obvious that, if these forces be referred to the line joining the two points, each will be less inclined to it at one than at the other; so that, as at one they produce equilibrium, at the other they must have a finite component in the direction of this line.

The quaternion investigation at once suggests the following kinematical solution of the problem. Suppose an inextensible string to be passed through a small movable ring, then through small rings at two of the fixed points, then again through the movable ring, and so on—one end of the string being fixed to the movable ring when the number of given points is odd, and to the first fixed ring when the number is even. When the string is drawn tight, *i.e.* when the sum of the lengths joining each fixed ring to the movable one is a minimum, the movable ring will evidently be in the position of the required point. Also, since the tension of the cord is the same throughout, the movable ring is kept in equilibrium by a set of equal forces in the directions of the lines joining it with the given points, which is the condition above found.

This kinematical process, equally with the quaternion one, whose form directly suggests it, gives easily the solution of the more general problem,—To find a point such that  $m$  times its distance from  $A$ , together with  $n$  times its distance from  $B$ , &c., may be a minimum.

## XII.

## NOTE ON THE HODOGRAPH.

[*Proceedings of the Royal Society of Edinburgh, December 16, 1867.*]

THE object of the present Note is to show, by a few examples (of which, however, the last is the only one of any real importance), how easily the geometrical ideas supplied by Hamilton's beautiful invention of the Hodograph enable us to dispense with analytical processes in the establishment of some of the fundamental propositions connected with the motion of a single particle, besides many others which are merely curious; and also how they help us to understand the full bearing of some of the analytical methods. Some of the simplest of such geometrical investigations are given in Tait and Steele's *Dynamics of a Particle*, and will not be reproduced here; though a few of the results will be assumed,—as, for instance, that when the acceleration is directed to a fixed point, and varies inversely as the square of the distance from it, the hodograph is a circle, and the path a conic section, of which the point is a focus.

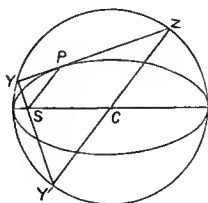

1. If the figure represent an ellipse and its auxiliary circle, it is known that the circle may be considered as the hodograph corresponding to planetary motion in the ellipse, but turned through a right angle. In fact, if  $YPZ$  be a tangent to the ellipse at  $P$ ,  $SY'$  is proportional to the speed at  $P$ , and perpendicular to it in direction. The actual speed bears to  $SY'$  the ratio of  $\mu$  to  $ha$ , in the usual notation.

Hence the tangent at  $Y'$  is perpendicular to  $SP$  (the direction of acceleration), and thus we have an immediate proof that  $SP$  is parallel to  $Y'Z$ . But by this



means we also get at once, and without analysis, the two well-known and peculiar first integrals, in the form

$$\dot{x} = -\frac{\mu}{h} \frac{y}{r}, \quad \dot{y} = \frac{\mu}{h} \left( \frac{x}{r} + e \right),$$

which cannot be directly deduced from the equations of acceleration

$$\ddot{x} = -\frac{\mu x}{r^3}, \quad \ddot{y} = -\frac{\mu y}{r^3}.$$

[The equation of the orbit is, of course,

$$h = xy\dot{y} - y\dot{x} = \frac{\mu}{h} (r + ex),$$

from which we see that

$$h^2 = \mu a (1 - e^2).]$$

2. The only central orbits whose hodographs also are described as central orbits, are those in which the acceleration varies directly as the distance from the centre.

Let  $S$  be the centre,  $P$  any point in the path,  $p$  the corresponding point in the hodograph,  $p'$  that in the hodograph of the hodograph. Then  $Sp'$  is parallel to the tangent at  $p$ , which again is parallel to  $SP$ . Hence  $PSp'$  is a straight line. Also, since  $p$  belongs (by hypothesis) to a central orbit, the tangent at  $p'$  is parallel to  $Sp$ , *i.e.*, to the tangent at  $P$ . Hence the locus of  $p'$  is similar to that of  $P$ , and therefore  $Sp'$  is *proportional to*  $SP$ . But  $Sp'$  represents the acceleration at  $P$ . Hence the proposition.

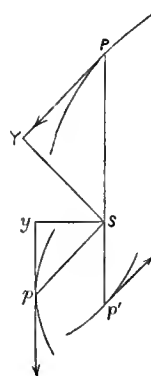

3. If  $\Pi$  be the acceleration in a central orbit,  $\Pi'$  that required for the description of the hodograph as a central orbit;  $h, h'$ , the moments of momentum, and  $r, r'$ , the radii vectores in the two orbits,

$$\Pi\Pi' = \frac{h'^2}{h^2} rr'.$$

In the figure above let  $SY = \varpi$  and  $Sy = \varpi'$  be the perpendiculars from  $S$  on the tangents at  $P$  and  $p$ ,  $\rho$  and  $\rho'$  the radii of curvature at  $P$  and  $p$ , then

$$\frac{r}{\varpi} = \frac{r'}{\varpi'}.$$

Also the speed at  $p$  is

$$\Pi = \frac{h\rho}{r^2}.$$

But, since we have

$$\Pi = r' \cdot \frac{r'}{\rho} \cdot \frac{r}{\varpi}$$

(as we see by expressing it in terms of the angular velocity of  $Sp$ ), if  $Sp'$  be called  $r''$ , we have

$$\Pi' = r'' \cdot \frac{r''}{\rho'} \cdot \frac{r'}{\varpi'}.$$

Hence, as

$$\omega r' = h, \quad \omega' r'' = h',$$

$$\Pi \Pi' = \frac{h}{r^2} \cdot \frac{r' r''^2}{\omega'} = \frac{h}{r^2} \frac{r' h'^2}{\omega^3} = \frac{h'^2}{h^2} r r'.$$

Or, more simply, if  $v$  be the speed in the orbit, we have, by expressing the centrifugal force in terms of the normal component of the acceleration,

$$\frac{v^2}{\rho} = \Pi \frac{\omega}{r}.$$

Hence

$$\frac{h^2}{\rho} = \Pi \frac{\omega^3}{r}.$$

[This is the well-known formula

$$\Pi = \frac{h^2}{\omega^3} \frac{d\omega}{dr}.]$$

Thus

$$\Pi \Pi' = \frac{h^2 r}{\omega^3 \rho} \cdot \frac{h'^2 r'}{\omega'^3 \rho'} = \frac{h'^2}{h^2} r r',$$

because from

$$r \omega' = r' \omega = h$$

we have at once

$$r^2 r'^2 = \omega \omega' \rho \rho'.$$

4. Again, if the hodograph be a circle described with uniform angular velocity about a point in its circumference, the path is the cycloidal brachistochrone.

For, if  $AP$  be the cycloid described by the point  $P$  of the circle  $SP$  rolling uniformly on the line  $AS$ , the speed at  $P$  is proportional to  $SP$ , and the direction of motion is perpendicular to  $SP$ . Hence the hodograph (turned through a right angle in its own plane) may be represented by the circle  $SP$ , described with uniform angular velocity about the point  $S$ . That the motion is due to constant acceleration perpendicular to  $AS$  is obvious from the fact that, if  $Pp$  be drawn perpendicular to  $AS$ ,  $SP^2 \propto Pp$ .

5. If the orbit be central, and be a circle described about a point in its circumference, the hodograph is a parabola described about the focus with angular velocity proportional to the radius vector.

For, if  $S$  be the centre of force,  $P$  the point in its circular orbit,  $p$  the corresponding point of the hodograph:  $qp$ , the tangent to the hodograph at  $p$ , must be parallel to  $SP$ ; and, therefore, if  $SQq$  be the tangent at  $S$ , the triangle  $pSq$  (being similar to  $PSQ$ ) is isosceles. Thus the locus of  $p$  is a parabola. Also the angular velocity of  $Sp$ , being the same as that of  $PQ$ , is double that of  $SP$ , and is, therefore, inversely as  $SP^2$ . But the length of  $Sp$  is inversely as the perpendicular from  $S$  upon  $PQ$ , i.e., inversely as  $SP^2$ .

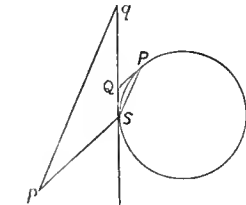

6. A point describes a logarithmic spiral with uniform angular velocity about the pole—find the acceleration.

Since the angular velocity of  $SP$  and the inclination of this line to the tangent are each constant, the linear velocity of  $P$  is as  $SP$ . Take a length  $PT$ , equal to  $nSP$ , to represent it. Then the hodograph, the locus of  $p$ , where  $Sp$  is parallel, and equal, to  $PT$ , is evidently another logarithmic spiral similar to the former, and described with the same uniform angular velocity. Hence  $pt$ , the acceleration required, is equal to  $eSp$ , and makes with  $Sp$  an angle equal to  $SPT$ . Hence, if  $Pu$  be drawn parallel and equal to  $pt$ , and  $uv$  parallel to  $PT$ , the whole acceleration  $Pu$  may be resolved into  $Pv$  and  $vu$ ; and  $Pvu$  is an isosceles triangle, whose base angles are each equal to the angle of the spiral. Hence  $Pv$  and  $vu$  bear constant ratios to  $Pu$ , or to  $SP$  or  $PT$ .

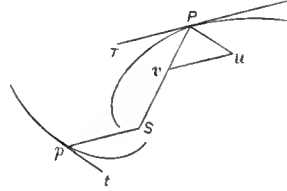

The acceleration, therefore, is composed of a central attractive part proportional to the distance, and a tangential retarding part proportional to the velocity.

And, if the resolved part of  $P$ 's motion parallel to any line in the plane of the spiral be considered, it is obvious that in it also the acceleration will consist of two parts—one directed towards a point in the line (the projection of the pole of the spiral), and proportional to the distance from it, the other proportional to the speed, but retarding the motion.

Hence a particle which, unresisted, would have a simple harmonic motion, has, when subject to resistance proportional to its speed, a motion represented by the resolved part of the spiral motion just described.

If  $\alpha$  be the angle of the spiral,  $\omega$  the angular velocity of  $SP$ , we have evidently

$$PT \cdot \sin \alpha = SP \cdot \omega, \text{ so that } \omega = n \sin \alpha.$$

Hence 
$$Pv = Pu = pt = \frac{PT^2}{SP} = \frac{\omega}{\sin \alpha} PT = \frac{\omega^2}{\sin^2 \alpha} SP = n^2 \cdot SP,$$

and 
$$vu = 2Pv \cdot \cos \alpha = \frac{2\omega \cos \alpha}{\sin \alpha} PT = k \cdot PT \text{ (suppose).}$$

Thus the central force at unit distance is  $n^2 = \frac{\omega^2}{\sin^2 \alpha}$ , and the coefficient of resistance is  $k = \frac{2\omega \cos \alpha}{\sin \alpha}$ .

The time of oscillation is evidently  $\frac{2\pi}{\omega}$ ; but, if there had been no resistance, the properties of simple harmonic motion show that it would have been  $\frac{2\pi}{n}$ ; so that it is increased by the resistance in the ratio  $\operatorname{cosec} \alpha : 1$ , or  $n : \sqrt{n^2 - \frac{k^2}{4}}$ .

The rate of diminution of  $SP$  is evidently

$$PT \cdot \cos \alpha = \frac{\omega \cos \alpha}{\sin \alpha} SP = \frac{k}{2} SP;$$

that is,  $SP$  diminishes in geometrical progression as time increases, the rate being  $\frac{k}{2}$  per unit of time per unit of length. By an ordinary result of arithmetic (compound interest payable every instant) the diminution of  $\log SP$  in unit of time is  $\frac{k}{2}$ .

This process of solution is only applicable to resisted harmonic vibrations when  $n$  is greater than  $\frac{k}{2}$ . When  $n$  is not greater than  $\frac{k}{2}$  the auxiliary curve can no longer be a logarithmic spiral, for the moving particle never describes more than a finite angle about the pole. A curve, derived from an equilateral hyperbola, by a process somewhat resembling that by which the logarithmic spiral is deduced from a circle, must be introduced; and then the geometrical method ceases to be simpler than the analytical one, so that it is useless to pursue the investigation farther, at least from this point of view.

## XIII.

## PHYSICAL PROOF THAT THE GEOMETRIC MEAN OF ANY NUMBER OF POSITIVE QUANTITIES IS LESS THAN THE ARITHMETIC MEAN.

[*Proceedings of the Royal Society of Edinburgh*, 16 February, 1868.]

IF a number of equal masses of the same material be given, at different temperatures, and enclosed in an envelope impervious to heat, they will finally assume a common temperature; which is the arithmetic mean of the initial temperatures, if the material be one whose specific heat does not vary with temperature.

But they may be brought to a common temperature by means of reversible thermodynamic engines employed to obtain the utmost amount of work from the initial unequal distribution. This question was first investigated by Thomson (*Phil. Mag.* 1853, "On the Restoration of Energy from an unequally heated Space"), and the application of his method to the present problem shows that the final common temperature of the masses, when as much work as possible has been obtained from them, is the geometric mean of the initial temperatures; but this investigation introduces the condition that the temperatures must be measured from the absolute zero.

Obviously the whole energy restored is proportional to the excess of the arithmetic over the geometric mean.

Far more complex analytical theorems may easily be proved by means of the above process; for instance, if  $t_1, t_2, \dots, c_1, c_2, \dots$  be any positive quantities, we have

$$\frac{c_1 t_1 + c_2 t_2 + \dots}{c_1 + c_2 + \dots} > (t_1^{c_1} t_2^{c_2} \dots)^{\frac{1}{c_1 + c_2 + \dots}}.$$

## XIV.

## ON THE DISSIPATION OF ENERGY.

[*Proceedings of the Royal Society of Edinburgh*, 16 February, 1868.]

THE paper contains some curious applications of the principle of dissipation to the conduction of heat, the connection of heat and electricity, thermo-electric currents, the electric convection of heat, &c. But in this abstract we confine ourselves to one very simple case of the conduction of heat, as the hypothesis on which it is investigated is fundamentally assumed in all the other applications.

If an infinite plate be kept permanently heated in layers, each of equal temperature throughout—the temperature rising gradually from one side to the other—the hypothesis is made that the temperatures of any three contiguous layers (of equal thickness) so adjust themselves that the least possible energy can be restored from the system of three. From this it immediately follows that if  $x_1$  be the thickness of the plate,  $t_0$  and  $t_1$  the (absolute) temperatures of its sides; and if the specific heat be the same for all temperatures between  $t_0$  and  $t_1$ : the temperature  $t$  at a distance  $x$  from the side at  $t_0$  will be

$$t = t_0 \epsilon^{x/x_1 \cdot \log t_1/t_0}.$$

But if  $k$  be the conductivity of the substance, at temperature  $t$ , we have for the flux of heat

$$f = k \frac{dt}{dx} \propto kt.$$

This must be the same throughout the plate, because there is equilibrium of temperature, and therefore

$$k \propto \frac{1}{t}.$$

The only published experiments, so far as I am aware, by which this result can be tested, are the very valuable series by Forbes (*Trans. Roy. Soc. Edin.*, 1864), which are, unfortunately, confined to iron. They agree uncommonly well with the above theoretical result, as the following short table shows:—

$t$	$k$	$kt$
290° C.	0·0164	4·76
330°	0·0130	4·24
400°	0·0110	4·40
440°	0·0105	4·58
476°	0·0100	4·76
561°	0·0090	5·04

No account has, in this abstract, been taken of the alteration of specific heat with temperature, which is as yet only approximately known, but which is applied in the paper to account completely for the increase of  $kt$  with temperature. As to the increase of  $kt$  at the low temperature of 290° C., it may be remarked that the first two or three numbers in Forbes' table are (as he points out) probably much less accurate than those which follow them, on account of the temperature at which they were obtained, which was but little above that of the atmosphere.

## XV.

## ON THE ROTATION OF A RIGID BODY ABOUT A FIXED POINT.

[*Transactions of the Royal Society of Edinburgh*, Vol. xxv. Received October 13th,  
Read December 21st, 1868.]

ALTHOUGH it is very improbable that there remains to be discovered any new, and at the same time simple, fact connected with a question which has been elaborately treated by many of the greatest mathematicians of this and the preceding century, the employment of a new mathematical method may enable us to present some of their results in a more intelligible form, and with far less expenditure of analytical power than has hitherto been deemed necessary; and it may give us such an insight into the question, that we shall be able easily to discover the mutual relations among the various processes which have been already employed; so far, at least, as these differ in principle, and not merely in the peculiar co-ordinates assumed for the purpose of simplifying the equations. Such a method is that of *Quaternions*, which seems to be expressly fitted for the symmetrical evolution of truths which are usually obtained by the ordinary Cartesian methods only after great labour of calculation, and by modes of attack so indirect, and at first sight so purposeless, as to bewilder all but a very small class of readers. Quaternions afford so clear a view of the nature of the question they are applied to, that even the student, if he have some little knowledge of them, can often see *why* a transformation is made, whose object he would have been unable to discover had the problem been masked in the unnecessarily artificial difficulties of Cartesian geometry, or the outrageously repulsive formulæ of spherical trigonometry.

By far the most elegant and most easily intelligible representations of the motion of a solid body yet discovered, are due to Poincot. With the following extract from



his splendid work, *Théorie Nouvelle de la Rotation des Corps* (*Liouville's Journal*, 1851), I most cordially agree,—though it appears to me that, when he does condescend to use analytical methods, he is by no means so happy as others have been, who, trusting to mathematical analysis alone, had not the benefit of his beautiful geometrical representations. But in perusing the extract, let the reader bear in mind that a *quaternion* equation is quite as suggestively intelligible, to those who understand it, as any geometrical diagram can possibly be. In fact, I might almost say, that it is *more* readily intelligible than diagrams usually are; for, in reading a work illustrated by figures, we have generally to go through a laborious explanation of what the figure is intended to represent before we can make use of it for further developments. On the other hand, a purely quaternion formula draws, as it were, its own figure in the reader's mind, and saves him at least the trouble just mentioned. In this way every one has his figures drawn so as best to suit himself, and is not perplexed by having to pick up the principles on which they have been drawn for him by another, very probably of a different mode of thought. Still, such words as the following, when properly applied, *not* to quaternions but, to ordinary so-called analysis, must always convey a much-needed warning:—"Gardons-nous de croire qu'une science soit faite quand on l'a réduite à des formules analytiques. Rien ne nous dispense d'étudier les choses en elles-mêmes, et de nous bien rendre compte des idées qui font l'objet de nos spéculations. N'oublions point que les résultats de nos calculs ont presque toujours besoin d'être vérifiés, d'un autre côté, par quelque raisonnement simple, ou par l'expérience. Que si le calcul seul peut quelquefois nous offrir une vérité nouvelle, il ne faut pas croire que, sur ce point même, l'esprit n'ait plus rien à faire: mais, au contraire, il faut songer que, cette vérité étant indépendante des méthodes ou des artifices qui ont pu nous y conduire, il existe certainement quelque démonstration simple qui pourrait la porter à l'évidence: ce qui doit être le grand objet et le dernier résultat de la science mathématique." . . . . "Ce n'est qu'une apparente fécondité de cette méthode de pur calcul qu'on appelle assez improprement l'*analyse*. Car si les théorèmes sont déjà connus on découvre bien vite les transformations à faire pour que les équations y répondent; mais quand on n'a aucune idée de ces théorèmes, on ne transforme guère qu'au hasard, et le plus souvent on n'arrive à rien. La vraie analyse est dans l'examen attentif du problème à résoudre, et dans ces premiers raisonnements qu'on fait pour le mettre en équations. Transformer ensuite ces équations, c'est-à-dire les combiner ensemble, ou en poser d'autres évidentes que l'on combine avec elles, n'est au fond que de la synthèse; à moins que l'idée de chaque transformation ne nous soit donnée par quelque vue nouvelle de l'esprit, ou quelque nouveau raisonnement, ce qui nous fait rentrer dans la véritable analyse. Hors de cette voie lumineuse, il n'y a donc plus d'analyse, mais une obscure *synthèse* de formules algébriques que l'on *pose*, pour ainsi dire, l'une sur l'autre, et sans trop prévoir ce que pourra donner cette combinaison. Voilà les idées nettes qu'il faut attacher aux mots: et c'est au fond ce que tout le monde paraît sentir, puisqu'on dit très-bien une *heureuse* transformation, et qu'on ne dit point un *heureux* raisonnement, ni une *heureuse* analyse."

I was led to the following investigations by a desire to simplify, if possible, by a symmetrical process, the usual modes of treating the rotation of a rigid body. The

methods ordinarily employed are essentially unsymmetrical, *e.g.* the determination, by means of three angles, of the position of the body at a given time, when its angular velocities about its principal axes are given, or can be found. It was not till after my investigations were nearly completed, and the chief fundamental equations had been communicated to the British Association at Norwich, that I became aware of the existence of Professor Cayley's admirable *Second Report on Theoretical Dynamics*\*, which contains an immense amount of valuable information, especially bearing on the present subject. From this I found that the notion of attaining symmetry, by seeking the single rotation which would bring the body from some initial position to its actual position at a given time, which had been suggested to me by Hamilton's† beautiful results, is due to Euler; and I also found that, by the help of certain formulæ due to Rodrigues, Cayley has completely solved the question in the *Cambridge Mathematical Journal*, vol. III. (1843)‡. Comparative symmetry, however, is only attained by means of a brilliant display of analytical power at a great expense of time and bewilderment to the ordinary reader. In the *Philosophical Magazine*, 1848, II., Cayley has translated some of his formulæ into quaternions, and has thus arrived, though by a very circuitous route, at the fundamental kinematical equation of the present paper (§ 7 below). He does not give it in its simplest form, and he remarks that he has "not ascertained whether it leads to any results of importance." Under these circumstances, I have had no hesitation in laying this paper before the Society; for although many of its more important results have been otherwise obtained, few, with the exception of those due to Hamilton (which will be given in their turn), have hitherto been arrived at so easily or in such simple forms.

As symmetry has been the particular object which I have had in view, by far the greater part of the investigation bears upon the determination of the quaternion, by which the transition can at one step be effected from any initial position to the actual position of the body at a given time; and a good many results have been retained, which are of more interest as properties of quaternions, than as regards their connection with the physical question. In the kinematical part of the paper, to which I proceed as a necessary preliminary, I have exhibited, for facility of comparison with other works on the subject, the values of this quaternion in terms of the various sets of co-ordinates usually employed. This, I need hardly say, does *not* lead to very simple or elegant results; but the fault is due, not to quaternions, but to the *unnaturalness* and want of symmetry of these common methods of attacking the problem. On the other hand, nothing can be neater than the set of formulæ which are suggested directly by quaternions.

\* Report on the Progress of the Solution of certain Special Problems of Dynamics.—*Brit. Ass. Report*, 1862.

† *Proc. R. I. A.*, 1846. See also §§ 1 and 4 below.

‡ See also *Cambridge and Dublin Math. Journal*, vol. I. (1846).

§§ 1—14. *Kinematics of a Rigid System with one Point fixed.*

1. If  $\epsilon$  represent the instantaneous axis of a rigid body, its length being employed to denote the angular velocity about it; then,  $\varpi$  being the vector of any point of the body, drawn from a point in the axis as origin, we obviously have (using Newton's convenient notation)

$$\dot{\varpi} = \frac{d\varpi}{dt} = V\epsilon\varpi \dots\dots\dots(1).$$

This formula was long ago given by Hamilton.

2. *Every infinitely small displacement of a Rigid System, one point of which is fixed, takes place about an instantaneous axis.*

Let  $\varpi, \varpi_1$ , be the vectors of any two points of the system, referred to the fixed point as origin; then, whatever displacements may occur, we must have (on account of the rigidity of the system)

$$T\varpi = \text{const.}, \quad T\varpi_1 = \text{const.}, \quad S\varpi\varpi_1 = \text{const.}$$

Hence, differentiating with respect to  $t$ ,

$$S\varpi\dot{\varpi} = 0, \quad S\varpi_1\dot{\varpi}_1 = 0, \quad S\dot{\varpi}\varpi_1 + S\varpi\dot{\varpi}_1 = 0 \dots\dots\dots(2).$$

The first shows that

$$\dot{\varpi} = V\epsilon\varpi,$$

where  $\epsilon$  is some vector. With this the third gives

$$S.\varpi(V\epsilon\varpi_1 - \dot{\varpi}_1) = 0,$$

which must be true for all values of  $\varpi$ . Hence we have also

$$\dot{\varpi}_1 = V\epsilon\varpi_1.$$

This is consistent with the second of equations (2), so that the existence of the instantaneous axis is proved. From the fact of its existence follows at once the representation of the motion, in every case, by the rolling of a cone fixed in the rigid system upon another cone fixed in space. The case of finite displacements will be treated farther on (§ 5 below).

3. *To find the instantaneous axis, when the vectors, and vector-velocities, of any two points of the system are given.*

Here we have to find  $\epsilon$  from the two equations

$$\dot{\varpi} = V\epsilon\varpi, \quad \dot{\varpi}_1 = V\epsilon\varpi_1.$$

They give by inspection

$$V\dot{\varpi}\varpi_1 = -\epsilon S\dot{\varpi}\varpi_1 = \epsilon S\varpi\dot{\varpi}_1,$$

or, more symmetrically,

$$\epsilon = \frac{\dot{\varpi}\dot{\varpi}_1 - \dot{\varpi}_1\dot{\varpi}}{S(\varpi\dot{\varpi}_1 - \dot{\varpi}\varpi_1)}.$$

4. If  $q$  be any quaternion, the operator

$$q( \ )q^{-1}$$

turns the vector, quaternion, or system, to which it is applied, about the axis of  $q$  through double the angle of  $q$ .

This was one of Hamilton's early\* discoveries in his new calculus, but it was independently obtained by Cayley (only a month or two later)† by the help of the formulæ of Rodrigues already referred to. Conversely, when its truth has been established by an independent process, these formulæ may be at once derived from it: not only far more simply, but even in a somewhat improved form.

The quaternion  $q$  may obviously be considered as a mere versor, since its tensor does not appear in the operator  $q( \ )q^{-1}$ , and a glance at the annexed figure proves,

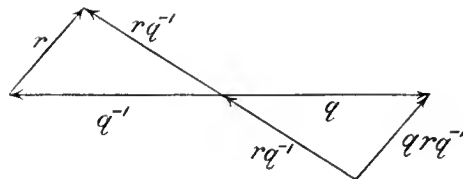

by the multiplication of versor arcs, the theorem above stated. (See Tait's *Quaternions*, § 353, or Hamilton's *Lectures*, § 282, and *Elements*, § 308 (9).)

5. In quaternions we have, of course, whatever be  $q$  and  $r$ ,

$$(qr)^{-1} = r^{-1}q^{-1}.$$

Hence

$$q \cdot r( \ )r^{-1} \cdot q^{-1} = qr( \ )(qr)^{-1},$$

which shows how to combine any two rotations into a single one.

6. Given the initial and final positions of any two vectors of a rigid system, drawn from the fixed point; to find the quaternion operator by which the rotation can be effected. Let them be  $\alpha, \beta, \alpha_1, \beta_1$ , and let  $q$  be the required quaternion, then

$$q\alpha q^{-1} = \alpha_1, \quad q\beta q^{-1} = \beta_1,$$

or

$$q\alpha = \alpha_1 q, \quad q\beta = \beta_1 q \dots\dots\dots (3).$$

Hence

$$S(\alpha - \alpha_1)q = 0, \quad S(\beta - \beta_1)q = 0,$$

or

$$Vq \parallel V(\alpha - \alpha_1)(\beta - \beta_1)$$

as we might at once have seen by the geometry of the question.

Hence

$$q = x + yV(\alpha - \alpha_1)(\beta - \beta_1).$$

\* *Proc. R. I. A.*, November 11, 1844.

† *Phil. Mag.*, Feb. 1845.

By the help of this, the first of equations (3) becomes

$$0 = x(\alpha - \alpha_1) + y\{V(\alpha - \alpha_1)(\beta - \beta_1) + \alpha - \alpha_1 V(\alpha - \alpha_1)(\beta - \beta_1)\}$$

or 
$$0 = x + yS(\alpha + \alpha_1)(\beta - \beta_1).$$

[The second of equations (3) merely gives us a condition which is equivalent to this, because

$$S(\alpha + \alpha_1)(\beta - \beta_1) = -S(\alpha - \alpha_1)(\beta + \beta_1)$$

or 
$$S\alpha\beta = S\alpha_1\beta_1.]$$

Thus, finally, 
$$q = y\{-S(\alpha + \alpha_1)(\beta - \beta_1) + V(\alpha - \alpha_1)(\beta - \beta_1)\}$$

$$= -y[(\beta - \beta_1)\alpha + \alpha_1(\beta - \beta_1)]$$

where, as was to be expected, the tensor is left indeterminate.

7. Given the instantaneous axis in terms of the time, it is required to find the single rotation which will bring the body from any initial position to its position at a given time.

If  $\alpha$  be the initial vector of a point of the body,  $\varpi$  the value of the same at time  $t$ , and  $q$  the required quaternion, we have

$$\varpi = q\alpha q^{-1} \dots \dots \dots (4).$$

Differentiating with respect to  $t$ , this gives

$$\begin{aligned} \dot{\varpi} &= \dot{q}\alpha q^{-1} - q\alpha q^{-1} \dot{q}q^{-1}, \\ &= \dot{q}q^{-1} \cdot q\alpha q^{-1} - q\alpha q^{-1} \cdot \dot{q}q^{-1}, \\ &= 2V \cdot (V\dot{q}q^{-1} \cdot q\alpha q^{-1}). \end{aligned}$$

But 
$$\dot{\varpi} = V\epsilon\varpi = V \cdot \epsilon q\alpha q^{-1}.$$

Hence, as  $q\alpha q^{-1}$  may be any vector whatever in the displaced body, we must have

$$\epsilon = 2V\dot{q}q^{-1} \dots \dots \dots (5).$$

This is the fundamental kinematical relation already referred to. Cayley's\* quaternion form of it (which will be understood by the help of § 13 below) is

$$\kappa(ip + jq + kr) = 2 \frac{d\Lambda}{dt} \Lambda + \frac{d\kappa}{dt},$$

where 
$$\Lambda = 1 + i\lambda + j\mu + kv.$$

8. The result of § 7 may be stated in even a simpler form than (5), for we have always, whatever quaternion  $q$  may be,

$$V\dot{q}q^{-1} = \frac{dUq}{dt} (Uq)^{-1}$$

\* *Phil. Mag.*, Sept. 1848.

and, therefore, if we suppose the tensor of  $q$ , which may have any value whatever, to be a constant (unity, for instance), we may write (5) in the form

$$\epsilon q = 2\dot{q} \dots\dots\dots (6).$$

An immediate consequence, which will be of use to us later, is

$$q \cdot q^{-1} \epsilon q = 2\dot{q} \dots\dots\dots (7).$$

9. It may appear to some that the demonstration of § 7, founded on the differentiation of quaternions, is not very convincing. For such it is easy to put it in an expanded form in which no process of differentiation of a *function* of a quaternion is alluded to—though in principle it is the same proof.

Let  $q$  become  $q + r$  in the indefinitely short interval  $\tau$ . Then the change of position of the extremity of

$$\varpi = q\alpha q^{-1}$$

may be expressed either as

$$V\epsilon\varpi \cdot \tau \text{ or as } (q + r)\alpha(q + r)^{-1} - q\alpha q^{-1}.$$

Hence

$$\begin{aligned} \tau V \cdot \epsilon q\alpha q^{-1} &= (q + r)\alpha(q + r)^{-1} - q\alpha q^{-1}, \\ &= q[(1 + q^{-1}r)\alpha(1 + q^{-1}r)^{-1} - \alpha]q^{-1}, \\ &= \frac{q}{T^2(1 + q^{-1}r)} \{(1 + q^{-1}r)\alpha(1 + K \cdot q^{-1}r) - (1 + q^{-1}r)(1 + K \cdot q^{-1}r)\alpha\}q^{-1} \\ &= \frac{2q}{T^2(1 + q^{-1}r)} \{(1 + q^{-1}r)V(Vq^{-1}r \cdot \alpha)\}q^{-1}. \end{aligned}$$

But  $r$  is the change of  $q$  in time  $\tau$ , and we may therefore write

$$r = \dot{q}\tau.$$

Substituting, expanding, and neglecting small quantities of the orders  $\tau^2$  and upwards, we have

$$\begin{aligned} V \cdot \epsilon q\alpha q^{-1} &= 2qV(Vq^{-1}\dot{q} \cdot \alpha)q^{-1} \\ &= q(Vq^{-1}\dot{q} \cdot \alpha - \alpha Vq^{-1}\dot{q})q^{-1} \\ &= q(Vq^{-1}\dot{q})q^{-1} \cdot q\alpha q^{-1} - q\alpha q^{-1} \cdot q(Vq^{-1}\dot{q})q^{-1} \\ &= V\dot{q}q^{-1} \cdot q\alpha q^{-1} - q\alpha q^{-1} \cdot V\dot{q}q^{-1} \\ &= 2V(V\dot{q}q^{-1} \cdot q\alpha q^{-1}) \end{aligned}$$

the same equation as in § 7.

9\*. [Inserted Dec. 19th, 1868.] A geometrical investigation may also easily be given, if for no other purpose than to serve as an instance of the justice of my introductory remarks on diagrams as compared with quaternion equations.

Let  $Q, Q'$  be the poles, on the unit-sphere, of the versor angles  $BQE', BQ'E'$ , whose bounding arcs intersect in  $E'$ ; and let  $P, P'$  be the poles of these bounding

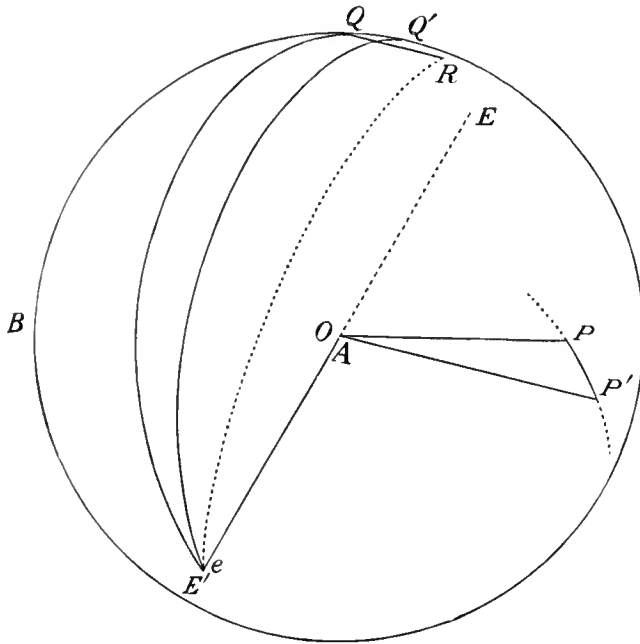

arcs,  $A$  the pole of  $QQ'B$  [ $A$  coincides with the projection of  $O$ , the centre of the sphere]. Then evidently  $\widehat{AP}(=q)$  and  $\widehat{AP'}(=q')$  are the versor arcs, corresponding to the above versor angles. Obviously the point  $E'$  is deduced from a point  $e$  on the other side of the sphere [whose projection coincides with that of  $E'$ ], by a rotation about  $Q$  through double of  $BQE'$ , or about  $Q'$  through double of  $BQ'E'$ . Hence we have obviously

$$\overline{OE'} = q \overline{Oe} q^{-1} = q' \overline{Oe} q'^{-1}.$$

Thus a rigid body may pass from the position  $q( )q^{-1}$  to the position  $q'( )q'^{-1}$ , whatever be  $q$  and  $q'$ , by a rotation about  $OE'$ . Also, by  $q( )q^{-1}$ ,  $Q$  remains fixed; but by  $q'( )q'^{-1}$  it moves to  $R$ , where  $\angle QE'R = 2\angle QE'Q' = 2\angle POP'$ .

Hence if  $\overline{OE'} = -U\epsilon = (U\epsilon)^{-1}$ , the versor arc  $PP'$  may be expressed by either of the equal quantities

$$(U\epsilon)^{\frac{2PP'}{\pi}} = q'q^{-1}.$$

But the actual rotation about  $\epsilon$  is  $2PP'$ , because  $Q$  moves to  $R$ . Hence if we put

$$q' = q + \dot{q}\delta t + \&c.,$$

we have

$$T\epsilon\delta t = 2PP',$$

and thus

$$\begin{aligned} 1 + \dot{q}q^{-1}\delta t + \&c. = (U\epsilon)\frac{T\epsilon\delta t}{\pi} = \cos\frac{\delta t T\epsilon}{2} + U\epsilon \sin\frac{\delta t T\epsilon}{2} \\ &= 1 + \frac{\epsilon}{2}\delta t + \&c. \end{aligned}$$

Hence, as in (6), when  $\delta t$  is indefinitely small

$$2\dot{q}q^{-1} = \epsilon.$$

10. To express  $q$  in terms of the usual angles  $\psi$ ,  $\theta$ ,  $\phi$ .

Here the vectors  $i, j, k$  in the original position of the body correspond to  $\overline{OA}$ ,

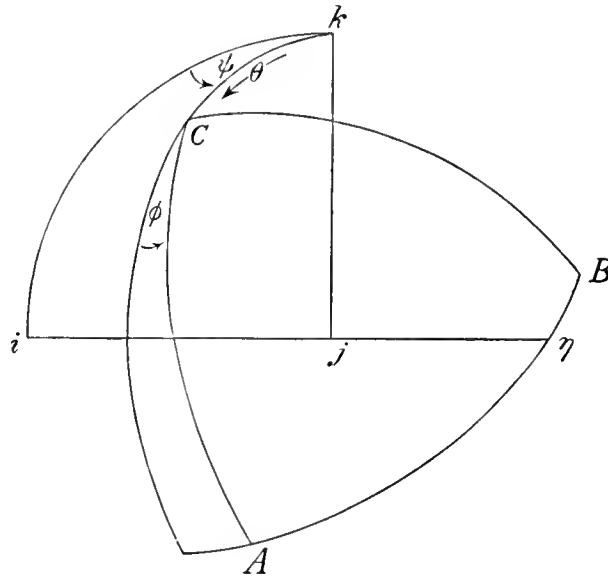

$\overline{OB}$ ,  $\overline{OC}$ , respectively, at time  $t$ . The transposition is effected by—*first*, a rotation  $\psi$  about  $k$ ; *second*, a rotation  $\theta$  about the new position of the line originally coinciding with  $j$ ; *third*, a rotation  $\phi$  about the final position of the line at first coinciding with  $k$ .

Let  $i, j, k$  be taken as the initial directions of the three vectors which at time  $t$  terminate at  $A, B, C$  respectively.

The rotation  $\psi$  about  $k$  has the operator

$$k^{\frac{\psi}{\pi}} ( ) k^{-\frac{\psi}{\pi}}.$$



This converts  $j$  into  $\eta$ , where

$$\eta = k^{\frac{\psi}{\pi}} j k^{-\frac{\psi}{\pi}} = j \cos \psi - i \sin \psi.$$

The body next rotates about  $\eta$  through an angle  $\theta$ . This has the operator

$$\eta^{\frac{\theta}{\pi}} ( ) \eta^{-\frac{\theta}{\pi}}.$$

It converts  $k$  into

$$\begin{aligned} \overline{OC} = \zeta &= \eta^{\frac{\theta}{\pi}} k \eta^{-\frac{\theta}{\pi}} = \left( \cos \frac{\theta}{2} + \eta \sin \frac{\theta}{2} \right) k \left( \cos \frac{\theta}{2} - \eta \sin \frac{\theta}{2} \right) \\ &= k \cos \theta + \sin \theta (i \cos \psi + j \sin \psi). \end{aligned}$$

The body now turns through the angle  $\phi$  about  $\zeta$ , the operator being

$$\zeta^{\frac{\phi}{\pi}} ( ) \zeta^{-\frac{\phi}{\pi}}.$$

Hence

$$\begin{aligned} q &= \zeta^{\frac{\phi}{\pi}} \eta^{\frac{\theta}{\pi}} k^{\frac{\psi}{\pi}} \\ &= \left( \cos \frac{\phi}{2} + \zeta \sin \frac{\phi}{2} \right) \left( \cos \frac{\theta}{2} + \eta \sin \frac{\theta}{2} \right) \left( \cos \frac{\psi}{2} + k \sin \frac{\psi}{2} \right) \\ &= \left( \cos \frac{\phi}{2} + \zeta \sin \frac{\phi}{2} \right) \left[ \cos \frac{\theta}{2} \cos \frac{\psi}{2} + k \cos \frac{\theta}{2} \sin \frac{\psi}{2} + \sin \frac{\theta}{2} \cos \frac{\psi}{2} (j \cos \psi - i \sin \psi) + \sin \frac{\theta}{2} \sin \frac{\psi}{2} (i \cos \psi + j \sin \psi) \right] \\ &= \left( \cos \frac{\phi}{2} + \zeta \sin \frac{\phi}{2} \right) \left[ \cos \frac{\theta}{2} \cos \frac{\psi}{2} - i \sin \frac{\theta}{2} \sin \frac{\psi}{2} + j \sin \frac{\theta}{2} \cos \frac{\psi}{2} + k \cos \frac{\theta}{2} \sin \frac{\psi}{2} \right] \\ &= \cos \frac{\phi}{2} \cos \frac{\theta}{2} \cos \frac{\psi}{2} + \sin \frac{\phi}{2} \sin \frac{\theta}{2} \sin \frac{\psi}{2} \sin \theta \cos \psi - \sin \frac{\phi}{2} \sin \frac{\theta}{2} \cos \frac{\psi}{2} \sin \theta \sin \psi - \sin \frac{\phi}{2} \cos \frac{\theta}{2} \sin \frac{\psi}{2} \cos \theta \\ &\quad + i \left( -\cos \frac{\phi}{2} \sin \frac{\theta}{2} \sin \frac{\psi}{2} + \sin \frac{\phi}{2} \cos \frac{\theta}{2} \cos \frac{\psi}{2} \sin \theta \cos \psi - \sin \frac{\phi}{2} \sin \frac{\theta}{2} \cos \frac{\psi}{2} \cos \theta + \sin \frac{\phi}{2} \cos \frac{\theta}{2} \sin \frac{\psi}{2} \sin \theta \sin \psi \right) \\ &\quad + j \left( \cos \frac{\phi}{2} \sin \frac{\theta}{2} \cos \frac{\psi}{2} + \sin \frac{\phi}{2} \cos \frac{\theta}{2} \cos \frac{\psi}{2} \sin \theta \sin \psi - \sin \frac{\phi}{2} \sin \frac{\theta}{2} \sin \frac{\psi}{2} \cos \theta - \sin \frac{\phi}{2} \cos \frac{\theta}{2} \sin \frac{\psi}{2} \sin \theta \cos \psi \right) \\ &\quad + k \left( \cos \frac{\phi}{2} \cos \frac{\theta}{2} \sin \frac{\psi}{2} + \sin \frac{\phi}{2} \cos \frac{\theta}{2} \cos \frac{\psi}{2} \cos \theta + \sin \frac{\phi}{2} \sin \frac{\theta}{2} \sin \frac{\psi}{2} \sin \theta \sin \psi + \sin \frac{\phi}{2} \sin \frac{\theta}{2} \cos \frac{\psi}{2} \sin \theta \cos \psi \right) \\ &= \cos \frac{\phi+\psi}{2} \cos \frac{\theta}{2} + i \sin \frac{\phi-\psi}{2} \sin \frac{\theta}{2} + j \cos \frac{\phi-\psi}{2} \sin \frac{\theta}{2} + k \sin \frac{\phi+\psi}{2} \cos \frac{\theta}{2}, \end{aligned}$$

which is, of course, essentially unsymmetrical.

11. *To find the usual equations connecting  $\psi$ ,  $\theta$ ,  $\phi$  with the angular velocities about three rectangular axes fixed in the body.*

Having the value of  $q$  in last section in terms of the three angles, it may be useful to employ it, in conjunction with equation (6) of § 8, partly as a verification of that equation. Of course, this is an exceedingly roundabout process, and does not in the least resemble the simple one which is immediately suggested by quaternions.

We have  $2\dot{q} = \epsilon q = \{\omega_1 \overline{OA} + \omega_2 \overline{OB} + \omega_3 \overline{OC}\} q,$

whence  $2q^{-1} \dot{q} = q^{-1} \{\omega_1 \overline{OA} + \omega_2 \overline{OB} + \omega_3 \overline{OC}\} q,$

or  $2\dot{q} = q (i\omega_1 + j\omega_2 + k\omega_3).$

This breaks up into the four (equivalent to three independent) equations

$$2 \frac{d}{dt} \left( \cos \frac{\phi + \psi}{2} \cos \frac{\theta}{2} \right) = -\omega_1 \sin \frac{\phi - \psi}{2} \sin \frac{\theta}{2} - \omega_2 \cos \frac{\phi - \psi}{2} \sin \frac{\theta}{2} - \omega_3 \sin \frac{\phi + \psi}{2} \cos \frac{\theta}{2}$$

$$2 \frac{d}{dt} \left( \sin \frac{\phi - \psi}{2} \sin \frac{\theta}{2} \right) = \omega_1 \cos \frac{\phi + \psi}{2} \cos \frac{\theta}{2} - \omega_2 \sin \frac{\phi + \psi}{2} \cos \frac{\theta}{2} + \omega_3 \cos \frac{\phi - \psi}{2} \sin \frac{\theta}{2}$$

$$2 \frac{d}{dt} \left( \cos \frac{\phi - \psi}{2} \sin \frac{\theta}{2} \right) = \omega_1 \sin \frac{\phi + \psi}{2} \cos \frac{\theta}{2} + \omega_2 \cos \frac{\phi + \psi}{2} \cos \frac{\theta}{2} - \omega_3 \sin \frac{\phi - \psi}{2} \sin \frac{\theta}{2}$$

$$2 \frac{d}{dt} \left( \sin \frac{\phi + \psi}{2} \cos \frac{\theta}{2} \right) = -\omega_1 \cos \frac{\phi - \psi}{2} \sin \frac{\theta}{2} + \omega_2 \sin \frac{\phi - \psi}{2} \sin \frac{\theta}{2} + \omega_3 \cos \frac{\phi + \psi}{2} \cos \frac{\theta}{2}.$$

From the second and third eliminate  $\dot{\phi} - \dot{\psi}$ , and we get by inspection

$$\cos \frac{\theta}{2} \cdot \dot{\theta} = (\omega_1 \sin \phi + \omega_2 \cos \phi) \cos \frac{\theta}{2},$$

or  $\dot{\theta} = \omega_1 \sin \phi + \omega_2 \cos \phi \dots\dots\dots(8).$

Similarly, by eliminating  $\dot{\theta}$  between the same two equations,

$$\sin \frac{\theta}{2} (\dot{\phi} - \dot{\psi}) = \omega_3 \sin \frac{\theta}{2} + \omega_1 \cos \phi \cos \frac{\theta}{2} - \omega_2 \sin \phi \cos \frac{\theta}{2}.$$

And from the first and last of the group of four

$$\cos \frac{\theta}{2} (\dot{\phi} + \dot{\psi}) = \omega_3 \cos \frac{\theta}{2} - \omega_1 \cos \phi \sin \frac{\theta}{2} + \omega_2 \sin \phi \sin \frac{\theta}{2}.$$

These last two equations give

$$\dot{\phi} + \dot{\psi} \cos \theta = \omega_3 \dots\dots\dots(9).$$

$$\dot{\phi} \cos \theta + \dot{\psi} = (-\omega_1 \cos \phi + \omega_2 \sin \phi) \sin \theta + \omega_3 \cos \theta.$$

From the last two we have

$$\dot{\psi} \sin \theta = -\omega_1 \cos \phi + \omega_2 \sin \phi \dots\dots\dots(10).$$

(8), (9), (10) are the forms in which the equations are usually given.

12. The essential want of symmetry, in the system of three angles usually employed, has led me to try various other systems. None of them, however, were quite symmetrical, and I therefore introduce only one of them here.

Suppose the position of the body to be determined by the angles  $\psi, \theta, \phi$ , through

which it has been made to turn about three rectangular axes which are fixed in it; and which may be considered as

$$\frac{1}{t} \int \bar{\omega}_1 dt, \quad \frac{1}{t} \int \bar{\omega}_2 dt, \quad \frac{1}{t} \int \bar{\omega}_3 dt \text{ respectively;}$$

$\bar{\omega}_1, \bar{\omega}_2, \bar{\omega}_3$  having values in general different from  $\omega_1, \omega_2, \omega_3$ , but easily deducible from them.

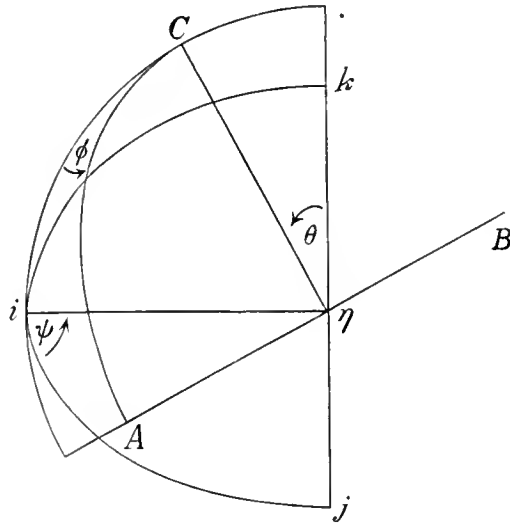

The essential difference between this process and the ordinary one (just treated), consists in using rotations about *each* of the three axes fixed in the body, instead of one about one axis, followed by another about a second, and then a final rotation about the *first* axis instead of the third.

We have first a rotation  $\psi$  about  $i$ , next  $\theta$  about the new position of  $j$ , and finally  $\phi$  about the final position of  $k$ .

$$i^{\frac{\psi}{\pi}} ( ) i^{-\frac{\psi}{\pi}}$$

is the operator due to the rotation about  $i$ .

It converts  $j$  into  $\eta = j \cos \psi + k \sin \psi,$

and  $k$  into  $k \cos \psi - j \sin \psi.$

Next, the operator due to the rotation  $\theta$  is

$$\eta^{\frac{\theta}{\pi}} ( ) \eta^{-\frac{\theta}{\pi}},$$

and this converts  $k \cos \psi - j \sin \psi$  into

$$\zeta = i \sin \theta + (k \cos \psi - j \sin \psi) \cos \theta.$$

Thus  $q = \zeta^{\frac{\phi}{\pi}} \eta^{\frac{\theta}{\pi}} i^{\frac{\psi}{\pi}} = \left( \cos \frac{\phi}{2} + \zeta \sin \frac{\phi}{2} \right) \left( \cos \frac{\theta}{2} + \eta \sin \frac{\theta}{2} \right) \left( \cos \frac{\psi}{2} + i \sin \frac{\psi}{2} \right).$

Substituting the above values of  $\zeta$  and  $\eta$ , multiplying out and arranging, we find finally

$$\begin{aligned} q &= \cos \frac{\phi}{2} \cos \frac{\theta}{2} \cos \frac{\psi}{2} - \sin \frac{\phi}{2} \sin \frac{\theta}{2} \sin \frac{\psi}{2} \\ &+ i \left( \cos \frac{\phi}{2} \cos \frac{\theta}{2} \sin \frac{\psi}{2} + \sin \frac{\phi}{2} \sin \frac{\theta}{2} \cos \frac{\psi}{2} \right) \\ &+ j \left( \cos \frac{\phi}{2} \sin \frac{\theta}{2} \cos \frac{\psi}{2} - \sin \frac{\phi}{2} \cos \frac{\theta}{2} \sin \frac{\psi}{2} \right) \\ &+ k \left( \cos \frac{\phi}{2} \sin \frac{\theta}{2} \sin \frac{\psi}{2} + \sin \frac{\phi}{2} \cos \frac{\theta}{2} \cos \frac{\psi}{2} \right). \end{aligned}$$

The expressions for  $\omega_1, \omega_2, \omega_3$  in terms of  $\phi, \theta, \psi$  and their differential coefficients are not very simple, and can scarcely be of any use.

We see by the equation of § 11 that

$$-\omega_1 = 2S \cdot iq^{-1}j.$$

If we put

$$q = w + ix + jy + kz$$

this gives

$$-\omega_1 = 2(x\dot{w} - w\dot{x} + y\dot{z} - z\dot{y})$$

from which the required expression may be obtained.

I have not examined the question, but I fancy that to deduce the constituents of the above value of  $q$  by means of spherical trigonometry would not be very easy.

13. *To deduce expressions for the direction-cosines of a set of rectangular axes in any position in terms of rational functions of three quantities only.*

Let  $\alpha, \beta, \gamma$  be unit-vectors in the directions of these axes. Let  $q$  be, as in § 7, the requisite quaternion operator for turning the co-ordinate axes into the position of this rectangular system. Then

$$q = w + xi + yj + zk$$

where, as in § 8, we may write

$$1 = w^2 + x^2 + y^2 + z^2.$$

Then we have

$$q^{-1} = w - xi - yj - zk,$$

and therefore

$$\begin{aligned} \alpha &= qi q^{-1} = (wi - x - yk + zj)(w - xi - yj - zk) \\ &= (w^2 + x^2 - y^2 - z^2)i + 2(wz + xy)j + 2(xz - wy)k, \end{aligned}$$

where the coefficients of  $i, j, k$  are the direction-cosines of  $\alpha$  as required. A similar process gives by inspection those of  $\beta$  and  $\gamma$ .

As given by Cayley, after Rodrigues, they have a slightly different and somewhat less simple form—to which, however, they are easily reduced by putting

$$w = \frac{x}{\lambda} = \frac{y}{\mu} = \frac{z}{\nu} = \frac{1}{\kappa^{\frac{1}{2}}}.$$

The geometrical interpretation of either set is obvious from the nature of quaternions. For (taking Cayley's notation) if  $\theta$  be the angle of rotation:  $\cos f, \cos g, \cos h$ , the direction-cosines of the axis, we have

$$q = w + xi + yj + zk = \cos \frac{\theta}{2} + \sin \frac{\theta}{2} (i \cos f + j \cos g + k \cos h),$$

so that

$$\begin{aligned} w &= \cos \frac{\theta}{2} \\ x &= \sin \frac{\theta}{2} \cos f \\ y &= \sin \frac{\theta}{2} \cos g \\ z &= \sin \frac{\theta}{2} \cos h. \end{aligned}$$

From these we pass at once to Rodrigues' subsidiary formulæ,

$$\begin{aligned} \kappa &= \frac{1}{w^2} = \sec^2 \frac{\theta}{2} \\ \lambda &= \frac{x}{w} = \tan \frac{\theta}{2} \cos f \\ &\&c. = \&c. \end{aligned}$$

14. In the system of three angles, corresponding to that usually employed in

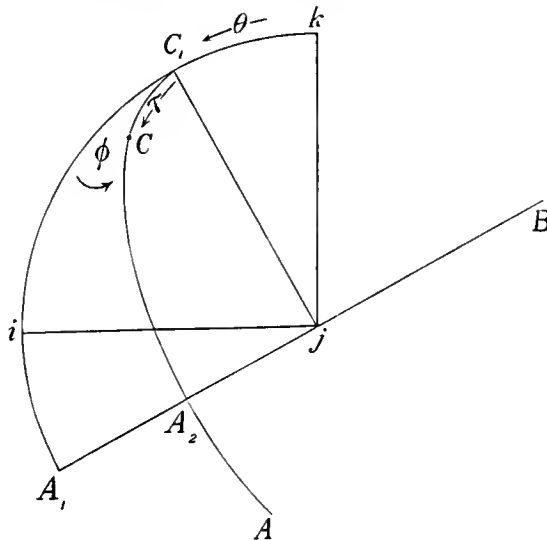

*astronomy*—viz.,  $\theta$  the longitude of node,  $\phi$  the inclination of orbit,  $\tau$  the angle from node in plane of orbit—to find the quaternion operator.

Here we relapse into the essential asymmetry of the method of § 10. *First*, a rotation  $\theta$  about  $j$ ; *second*, a rotation  $\phi$  about the new position of  $k$ ; *third*, a rotation  $\tau$  about the final position of what was originally  $j$ . The connection of this process with that of § 10 is sufficiently obvious.

Here  $j^{\frac{\theta}{\pi}} ( ) j^{-\frac{\theta}{\pi}}$  is the operator for  $\theta$ , and converts  $k$  into

$$\begin{aligned}\overline{OC}_1 = \eta &= \left( \cos \frac{\theta}{2} + j \sin \frac{\theta}{2} \right) k \left( \cos \frac{\theta}{2} - j \sin \frac{\theta}{2} \right) \\ &= i \sin \theta + k \cos \theta.\end{aligned}$$

Next, the operator for  $\phi$  is

$$\eta^{\frac{\phi}{\pi}} ( ) \eta^{-\frac{\phi}{\pi}},$$

and converts  $j$  into

$$\begin{aligned}\overline{OB} = \zeta &= \left\{ \cos \frac{\phi}{2} + \sin \frac{\phi}{2} (i \sin \theta + k \cos \theta) \right\} j \left\{ \cos \frac{\phi}{2} - \sin \frac{\phi}{2} (i \sin \theta + k \cos \theta) \right\} \\ &= -i \sin \phi \cos \theta + j \cos \phi + k \sin \phi \sin \theta.\end{aligned}$$

Hence we have

$$\begin{aligned}q &= \zeta^{\frac{\tau}{\pi}} \eta^{\frac{\phi}{\pi}} j^{\frac{\theta}{\pi}} \\ &= \left[ \cos \frac{\tau}{2} + \sin \frac{\tau}{2} (-i \sin \phi \cos \theta + j \cos \phi + k \sin \phi \sin \theta) \right] \left\{ \cos \frac{\phi}{2} + \sin \frac{\phi}{2} (i \sin \theta + k \cos \theta) \right\} \left( \cos \frac{\theta}{2} + j \sin \frac{\theta}{2} \right) \\ &= \left[ \cos \frac{\tau}{2} + \sin \frac{\tau}{2} (-i \sin \phi \cos \theta + j \cos \phi + k \sin \phi \sin \theta) \right] \left( \cos \frac{\phi}{2} \cos \frac{\theta}{2} + i \sin \frac{\phi}{2} \sin \frac{\theta}{2} + j \cos \frac{\phi}{2} \sin \frac{\theta}{2} + k \sin \frac{\phi}{2} \cos \frac{\theta}{2} \right) \\ &= \cos \frac{\tau+\theta}{2} \cos \frac{\phi}{2} + i \sin \frac{\theta-\tau}{2} \sin \frac{\phi}{2} + j \sin \frac{\tau+\theta}{2} \cos \frac{\phi}{2} + k \cos \frac{\theta-\tau}{2} \sin \frac{\phi}{2}.\end{aligned}$$

As a verification, we have by § 11

$$\begin{aligned}\overline{OA} &= qiq^{-1} \\ &= (w^2 + x^2 - y^2 - z^2) i + 2(wz + xy) j + 2(xz - wy) k \\ &= \left[ \cos(\theta + \tau) \cos^2 \frac{\phi}{2} - \cos(\theta - \tau) \sin^2 \frac{\phi}{2} \right] i + \cos \tau \sin \phi j + \left[ \sin(\theta - \tau) \sin^2 \frac{\phi}{2} - \sin(\theta + \tau) \cos^2 \frac{\phi}{2} \right] k \\ &= (\cos \theta \cos \tau \cos \phi - \sin \theta \sin \tau) i + \cos \tau \sin \phi j + (-\sin \theta \cos \tau \cos \phi - \cos \theta \sin \tau) k.\end{aligned}$$

The coefficients of  $i$ ,  $j$ ,  $k$ , in this are the usual expressions for three of the direction-cosines. The other six may be obtained by the same process.

To express the angular velocities about  $OA$ ,  $\overline{OB}$ ,  $\overline{OC}$  in terms of the three angles  $\theta$ ,  $\phi$ ,  $\tau$ , we have at once

$$\begin{aligned} -\omega_1 &= 2S \cdot iq^{-1} \dot{q} \\ &= 2(x\dot{v} - v\dot{x} + y\dot{z} - z\dot{y}) \\ &= -\dot{\theta} \cos \tau \sin \phi - \dot{\phi} \sin \tau. \end{aligned}$$

And the others can be found in a similar manner.

§§ 15—60. *Kinetics of a Rigid Body with one Point Fixed.*

15. Having premised these kinematical theorems, we pass to the consideration of the motion of a rigid *mass*. It was of course at once obvious to Hamilton (*Proc. R. I. A.* 1847), that if  $\varpi$  be (as in § 7) the vector of the portion  $m$  of the mass referred to the fixed point,  $\beta$  the vector-force acting at  $m$ , Lagrange's general equation of motion takes in quaternions the form

$$\Sigma \cdot V\varpi(m\ddot{\varpi} - \beta) = 0,$$

or, if we put

$$\psi = \Sigma \cdot V\varpi\beta$$

so that  $\psi$  denotes the vector-couple acting on the body,

$$\Sigma \cdot mV\varpi\ddot{\varpi} = \psi \dots\dots\dots (11).$$

This is our sole dynamical equation.

16. Integrating once with respect to  $t$ , we have, putting

$$\gamma = \int \psi dt \dots\dots\dots (12),$$

$$\Sigma \cdot mV\varpi\dot{\varpi} = \gamma \dots\dots\dots (13),$$

where, if we please, we may omit the  $V$ , as  $\varpi\dot{\varpi}$  is necessarily a vector.

Now, by the kinematical relation in § 1, if  $\epsilon$  be the vector instantaneous axis, we may write (13) as

$$\Sigma \cdot m\varpi V\epsilon\varpi = \gamma \dots\dots\dots (14).$$

17. From these equations Hamilton has deduced, in an extremely simple way, many known results of great interest. For instance, if  $\psi$  vanish, *i.e.*, if there be no applied forces,  $\gamma$  is a constant vector, and (operating on (14) or (13) by  $S \cdot \epsilon$ )

$$S\epsilon\gamma = \Sigma \cdot m(V\epsilon\varpi)^2 = \Sigma m\dot{\varpi}^2 = -h^2 \dots\dots\dots (15),$$

a constant, by the principle of conservation of energy.

$$\text{Of these equations} \quad \Sigma m(V\epsilon\varpi)^2 = -h^2$$

denotes obviously an ellipsoid fixed in the body, and such that  $\epsilon$  is a radius-vector

of it. The tangent plane to it at the extremity of  $\epsilon$  is easily seen to be the fixed plane

$$Se\gamma = -h^2.$$

Hence we have at once Poinso't's beautiful construction of the motion, by the rolling of the central ellipsoid on the invariable plane. But this, although extremely elegant, is not well adapted to assist us in the determination of the position of the body in space after a given time.

18. In most of the investigations which follow, we shall use the form (14) as given by Hamilton; and we shall omit for the present the consideration of whether  $\gamma$  is a constant vector or not.

19. Let  $\alpha$  be the initial position of  $\varpi$ ,  $q$  the quaternion by which the body can be at one step transferred from its initial position to its position at time  $t$ . Then

$$\varpi = q\alpha q^{-1}$$

and Hamilton's equation (14) becomes

$$\Sigma . m q \alpha q^{-1} V . \epsilon q \alpha q^{-1} = \gamma,$$

or

$$\Sigma . m q \{ \alpha S . \alpha q^{-1} \epsilon q - q^{-1} \epsilon q \alpha^2 \} q^{-1} = \gamma.$$

Let

$$\phi \rho = \Sigma . m (\alpha S \alpha \rho - \alpha^2 \rho) \dots\dots\dots(16),$$

where  $\phi$  is a self-conjugate linear and vector function, whose constituent vectors are fixed in the body in its initial position. Then the previous equation may be written .

$$q \phi (q^{-1} \epsilon q) q^{-1} = \gamma,$$

or

$$\phi (q^{-1} \epsilon q) = q^{-1} \gamma q.$$

For simplicity let us write

$$\left. \begin{aligned} q^{-1} \epsilon q &= \eta \\ q^{-1} \gamma q &= \zeta \end{aligned} \right\} \dots\dots\dots(17).$$

Then Hamilton's dynamical equation becomes simply

$$\phi \eta = \zeta \dots\dots\dots(18).$$

20. It is easy to see what the new vectors  $\eta$  and  $\zeta$  represent. For we may write (17) in the form

$$\left. \begin{aligned} \epsilon &= q \eta q^{-1} \\ \gamma &= q \zeta q^{-1} \end{aligned} \right\} \dots\dots\dots(17)',$$

from which it is obvious that  $\eta$  is that vector in the initial position of the body which, at time  $t$ , becomes the instantaneous axis in the moving body. When no forces act,  $\gamma$  is constant, and  $\zeta$  is the initial position of the vector which, at time  $t$ , is perpendicular to the invariable plane.



21. The complete solution of the problem is contained in equations (7), (17), (18).\* Writing them again we have, attending to (17), while introducing  $\eta$  instead of  $\epsilon$  into (7),

$$q\eta = 2\dot{q} \dots\dots\dots (7),$$

$$\gamma q = q\zeta \dots\dots\dots (17),$$

$$\phi\eta = \zeta \dots\dots\dots (18).$$

We have only to eliminate  $\zeta$  and  $\eta$ , and we get

$$2\dot{q} = q\phi^{-1}(q^{-1}\gamma q) \dots\dots\dots (19),$$

in which  $q$  is now the only unknown;  $\gamma$ , if variable, being supposed known in terms of  $q$  and  $t$ . It is hardly conceivable that any simpler, or more easily interpretable, equation for  $q$  can be presented until symbols are devised far more comprehensive in their meaning than any we yet have.

22. Before entering into considerations as to the integration of this equation, we may investigate some other consequences of the group of equations in § 21. Thus, for instance, differentiating (17), we have

$$\gamma\dot{q} + \dot{\gamma}q = \dot{q}\zeta + q\dot{\zeta},$$

and, eliminating  $\dot{q}$  by means of (7)

$$\gamma q\eta + 2\dot{\gamma}q = q\eta\zeta + 2q\dot{\zeta},$$

whence

$$\dot{\zeta} = V\zeta\eta + q^{-1}\dot{\gamma}q;$$

which gives, in the case when no forces act, the forms

$$\dot{\zeta} = V\zeta\phi^{-1}\zeta \dots\dots\dots (20),$$

and (as  $\dot{\zeta} = \phi\dot{\eta}$ ),

$$\phi\dot{\eta} = -V \cdot \eta\phi\eta \dots\dots\dots (21).$$

To each of these the term  $q^{-1}\dot{\gamma}q$ , or  $q^{-1}\psi q$ , must be added on the right, if forces act.

23. It is now desirable to examine the formation of the function  $\phi$ . By its definition (16) we have

$$\begin{aligned} \phi\rho &= \Sigma . m (\alpha S\alpha\rho - \alpha^2\rho) \\ &= -\Sigma . m\alpha V\alpha\rho. \end{aligned}$$

Hence

$$-S\rho\phi\rho = \Sigma . m (TV\alpha\rho)^2,$$

\* To these it is unnecessary to add

$$Tq = \text{constant},$$

as this constancy of  $Tq$  is proved by the form of (7). For, had  $Tq$  been variable, there must have been a quaternion in place of the vector  $\eta$ . In fact,

$$\frac{d}{dt} (Tq)^2 = 2S \cdot \dot{q}Kq = (Tq)^2 S\eta = 0.$$

so that  $-S\rho\phi\rho$  is the moment of inertia of the body about the vector  $\rho$ , multiplied by the square of the tensor of  $\rho$ . Thus the equation

$$S\rho\phi\rho = -h^2,$$

evidently belongs to an ellipsoid, of which the radii-vectores are inversely as the square roots of the moments of inertia about them\*; so that, if  $i, j, k$  be taken as unit vectors in the directions of its axes respectively, we have

$$\left. \begin{aligned} Si\phi i &= -A, \\ Sj\phi j &= -B, \\ Sk\phi k &= -C, \end{aligned} \right\} \dots\dots\dots(22),$$

$A, B, C$ , being the principal moments of inertia. Consequently

$$\phi\rho = -\{AiSi\rho + BjSj\rho + CkSk\rho\} \dots\dots\dots(23).$$

Thus the equation (21) for  $\eta$  breaks up, if we put

$$\eta = i\omega_1 + j\omega_2 + k\omega_3$$

into the three following scalar equations

$$\left. \begin{aligned} A\dot{\omega}_1 + (C - B)\omega_2\omega_3 &= 0, \\ B\dot{\omega}_2 + (A - C)\omega_3\omega_1 &= 0, \\ C\dot{\omega}_3 + (B - A)\omega_1\omega_2 &= 0, \end{aligned} \right\}$$

which are the same as those of Euler. Only, it is to be understood that the equations just written are not primarily to be considered as equations of rotation. They rather express, with reference to fixed axes in the initial position of the body, the motion of the extremity,  $\omega_1, \omega_2, \omega_3$  of the vector corresponding to the instantaneous axis in the moving body. If, however, we consider  $\omega_1, \omega_2, \omega_3$  as standing for their values in terms of  $w, x, y, z$  (§ 27 below), or any other coordinates employed to refer the body to fixed axes, they *are* the equations of motion.

Similar remarks apply to the equation which determines  $\zeta$ , for if we put

$$\zeta = i\varpi_1 + j\varpi_2 + k\varpi_3,$$

(20) may be reduced to three scalar equations of the form

$$\dot{\varpi}_1 + \left(\frac{1}{C} - \frac{1}{B}\right)\varpi_2\varpi_3 = 0.$$

24. Euler's equations in their usual form are easily deduced from what precedes. For, let

$$\phi\rho = q\phi(q^{-1}\rho q)q^{-1}$$

whatever be  $\rho$ ; that is, let  $\phi$  represent with reference to the moving principal axes

\* For further information about this equation, see Hamilton, *Proc. R. I. A.*, 1847, and *Elements of Quaternions*, p. 755. Also Tait, *Quaternions*, § 367 (3rd ed. § 387).

what  $\phi$  represents with reference to the principal axes in the initial position of the body, and we have

$$\begin{aligned} \varphi \dot{\epsilon} &= q\phi(q^{-1}\dot{\epsilon}q)q^{-1} = q\phi(\dot{\eta})q^{-1} \\ &= q\dot{\zeta}q^{-1} = qV(\zeta\phi^{-1}\zeta)q^{-1} \\ &= -qV(\eta\phi\eta)q^{-1} \\ &= -V.q\eta\phi(\eta)q^{-1} \\ &= -V.q\eta q^{-1}q\phi(q^{-1}\epsilon q)q^{-1} \\ &= -V.\epsilon\varphi\epsilon, \end{aligned}$$

which is the required expression.

But perhaps the simplest mode of obtaining this equation is to start with Hamilton's un-integrated equation (11), which for the case of no forces is simply

$$\Sigma . m V\omega\ddot{\omega} = 0.$$

But from

$$\dot{\omega} = V\epsilon\omega$$

we deduce

$$\begin{aligned} \ddot{\omega} &= V\epsilon\dot{\omega} + V\dot{\epsilon}\omega \\ &= \omega\epsilon^2 - \epsilon S\epsilon\omega + V\dot{\epsilon}\omega, \end{aligned}$$

so that

$$\Sigma . m (V\epsilon\omega S\epsilon\omega - \dot{\epsilon}\omega^2 + \omega S\dot{\epsilon}\omega) = 0.$$

If we look at equation (16), and remember that  $\varphi$  differs from  $\phi$  simply in having  $\omega$  substituted for  $\alpha$ , we see that this may be written

$$V\epsilon\varphi\epsilon + \varphi\dot{\epsilon} = 0,$$

the equation before obtained. The first mode of arriving at it has been given because it leads to an interesting set of transformations; for which reason we append other two.

By (17)

$$\gamma = q\zeta q^{-1},$$

therefore

$$0 = \dot{q}q^{-1} . q\zeta q^{-1} + q\dot{\zeta}q^{-1} - q\zeta q^{-1}\dot{q}q^{-1},$$

or

$$\begin{aligned} q\dot{\zeta}q^{-1} &= 2V . \gamma V\dot{q}q^{-1} \\ &= V\gamma\epsilon. \end{aligned}$$

But, by the beginning of this section, and by (14), this is again the equation lately proved.

Perhaps, however, the following is neater\*.

By (14)

$$\varphi\epsilon = \gamma.$$

Hence

$$\begin{aligned} \varphi\dot{\epsilon} = -\dot{\varphi}\epsilon &= -\Sigma . m (\dot{\omega} V\epsilon\omega + \omega V\epsilon\dot{\omega}) \\ &= -\Sigma . m \dot{\omega} S\epsilon\omega \\ &= -V . \epsilon \Sigma . m \omega S\epsilon\omega \\ &= -V\epsilon\varphi\epsilon. \end{aligned}$$

\* [Inserted Dec. 19, 1868.] I have lately found that Hamilton, in his *Elements of Quaternions* (1866), has obtained this equation in a manner almost identical with that last given.

25. However they are obtained, such equations as those of § 23 were shown long ago by Euler to be integrable as follows.

$$\text{Putting} \quad 2 \int \omega_1 \omega_2 \omega_3 dt = s,$$

$$\text{we have} \quad A\omega_1^2 = A\Omega_1^2 + (B - C)s$$

with other two equations of the same form. Hence

$$2dt = \int \frac{ds}{\left(\Omega_1^2 + \frac{B-C}{A}s\right)^{\frac{1}{2}} \left(\Omega_2^2 + \frac{C-A}{B}s\right)^{\frac{1}{2}} \left(\Omega_3^2 + \frac{A-B}{C}s\right)^{\frac{1}{2}}},$$

so that  $t$  is known in terms of  $s$  by an elliptic integral. Thus, finally,  $\eta$  or  $\zeta$  may be expressed in terms of  $t$ ; and in some of the succeeding investigations for  $q$  we shall suppose this to have been done. It is with this integration, or an equivalent one, that most writers on the farther development of the subject have commenced their investigations.

26. By § 16,  $\gamma$  is evidently the vector moment of momentum of the rigid body; and the kinetic energy is, as in § 17,

$$-\frac{1}{2} \Sigma . m \dot{\omega}^2 = -\frac{1}{2} S \epsilon \gamma.$$

But

$$S \epsilon \gamma = S . q^{-1} \epsilon q q^{-1} \gamma q = S \eta \zeta,$$

so that when no forces act

$$S \zeta \phi^{-1} \zeta = S \eta \phi \eta = -h^2.$$

But, by (17), we have also

$$T \zeta = T \gamma, \text{ or } T \phi \eta = T \gamma,$$

so that we have, for the equations of the cones described in the initial position of the body by  $\eta$  and  $\zeta$ , that is, for the cones described in the moving body by the instantaneous axis and by the perpendicular to the invariable plane,

$$h^2 \zeta^2 + \gamma^2 S \zeta \phi^{-1} \zeta = 0,$$

$$h^2 (\phi \eta)^2 + \gamma^2 S \eta \phi \eta = 0.$$

This is on the supposition that  $\gamma$  and  $h$  are constants. If forces act, these quantities are functions of  $t$ , and the equations of the cones then described in the body must be found by eliminating  $t$  between the respective equations. The final results to which such a process will lead must, of course, depend entirely upon the way in which  $t$  is involved in these equations, and therefore no general statement on the subject can be made.

27. Recurring to our equations for the determination of  $q$ , and taking first the

case of no forces, we see that, if we assume  $\eta$  to have been found (as in § 25) by means of elliptic integrals, we have to solve the equation

$$q\eta = 2\dot{q}^*,$$

that is, we have to integrate a system of four other differential equations harder than the first.

Putting, as in § 23,  $\eta = i\omega_1 + j\omega_2 + k\omega_3,$

where  $\omega_1, \omega_2, \omega_3$  are supposed to be known functions of  $t$ , and

$$q = w + ix + jy + kz,$$

this system is

$$\frac{1}{2} dt = \frac{dw}{W} = \frac{dx}{X} = \frac{dy}{Y} = \frac{dz}{Z},$$

where

$$W = -\omega_1x - \omega_2y - \omega_3z,$$

$$X = \omega_1w + \omega_3y - \omega_2z,$$

$$Y = \omega_2w + \omega_1z - \omega_3x,$$

$$Z = \omega_3w + \omega_2x - \omega_1y,$$

or, as suggested by Cayley to bring out the skew symmetry,

$$X = \omega_3y - \omega_2z + \omega_1w,$$

$$Y = -\omega_3x + \omega_1z + \omega_2w,$$

$$Z = \omega_2x - \omega_1y + \omega_3w,$$

$$W = -\omega_1x - \omega_2y - \omega_3z.$$

\* To get an idea of the nature of this equation, let us integrate it on the supposition that  $\eta$  is a constant vector. By differentiation and substitution, we get

$$2\ddot{q} = \dot{q}\eta = \frac{1}{2}\eta^2q.$$

Hence

$$q = Q_1 \cos \frac{T\eta}{2} t + Q_2 \sin \frac{T\eta}{2} t.$$

Substituting in the given equation we have

$$T\eta \left( -Q_1 \sin \frac{T\eta}{2} t + Q_2 \cos \frac{T\eta}{2} t \right) = \left( Q_1 \cos \frac{T\eta}{2} t + Q_2 \sin \frac{T\eta}{2} t \right) \eta.$$

Hence

$$T\eta \cdot Q_2 = Q_1\eta,$$

$$-T\eta \cdot Q_1 = Q_2\eta,$$

which are virtually the same equation—and thus

$$\begin{aligned} q &= Q_1 \left( \cos \frac{T\eta}{2} t + U\eta \sin \frac{T\eta}{2} t \right) \\ &= Q_1 (U\eta)^{\frac{tT\eta}{\pi}}. \end{aligned}$$

And the interpretation of  $q ( ) q^{-1}$  will obviously then be a rotation about  $\eta$  through the angle  $tT\eta$ , together with any other arbitrary rotation whatever. Thus any position whatever may be taken as the initial one of the body—and  $Q_1 ( ) Q_1^{-1}$  brings it to its required position at time  $t=0$ .

Here, of course, one integral is

$$w^2 + x^2 + y^2 + z^2 = \text{constant.}$$

It may suffice thus to have alluded to a possible mode of solution, which, except for very simple values of  $\eta$ , involves very great difficulties. The quaternion solution, when  $\eta$  is of constant length and revolves uniformly in a right cone, will be given later.

28. If, on the other hand, we eliminate  $\eta$ , we have to integrate

$$q\phi^{-1}(q^{-1}\gamma q) = 2\dot{q},$$

so that one integration theoretically suffices. But, in consequence of the present imperfect development of the quaternion calculus, the only known method of effecting this is to reduce the quaternion equation to a set of four ordinary differential equations of the first order. It may be interesting to form these equations.

Put  $q = w + ix + jy + kz,$   
 and  $\gamma = ia + jb + kc,$

then, by ordinary quaternion multiplication, we easily reduce the given equation to the following set:—

$$\frac{dt}{2} = \frac{dw}{W} = \frac{dx}{X} = \frac{dy}{Y} = \frac{dz}{Z} \dots\dots\dots(24),$$

where

	$W = -x\mathfrak{A} - y\mathfrak{B} - z\mathfrak{C}$	or	$X = y\mathfrak{C} - z\mathfrak{B} + w\mathfrak{A}$
	$X = w\mathfrak{A} + y\mathfrak{C} - z\mathfrak{B}$		$Y = -x\mathfrak{C} + z\mathfrak{A} + w\mathfrak{B}$
	$Y = w\mathfrak{B} + z\mathfrak{A} - x\mathfrak{C}$		$Z = x\mathfrak{B} - y\mathfrak{A} + w\mathfrak{C}$
	$Z = w\mathfrak{C} + x\mathfrak{B} - y\mathfrak{A}$		$W = -x\mathfrak{A} - y\mathfrak{B} - z\mathfrak{C}$

and

$$\mathfrak{A} = \frac{1}{A} [a(w^2 - x^2 - y^2 - z^2) + 2x(ax + by + cz) + 2w(bz - cy)]$$

$$\mathfrak{B} = \frac{1}{B} [b(w^2 - x^2 - y^2 - z^2) + 2y(ax + by + cz) + 2w(cx - az)]$$

$$\mathfrak{C} = \frac{1}{C} [c(w^2 - x^2 - y^2 - z^2) + 2z(ax + by + cz) + 2w(ay - bx)]$$

$W, X, Y, Z$  are thus *homogeneous* functions of  $w, x, y, z$  of the third degree.

Perhaps the simplest way of obtaining these equations is to translate the group of § 21 into  $w, x, y, z$  at once—instead of using the equation from which  $\zeta$  and  $\eta$  are eliminated.

We thus see that  $\eta = i\mathfrak{A} + j\mathfrak{B} + k\mathfrak{C}.$

One obvious integral of these equations ought to be

$$w^2 + x^2 + y^2 + z^2 = \text{constant},$$

which has been assumed all along. In fact, we see at once that

$$wW + xX + yY + zZ = 0$$

identically, which leads to the above integral.

These equations appear to be worthy of attention, partly because of the homogeneity of the denominators  $W, X, Y, Z$ , but particularly as they afford (what does not appear to have been sought) the means of solving this celebrated problem *at one step*, that is, without the previous integration of Euler's equations (§ 23).

A set of equations identical with these, but not in a homogeneous form (being expressed, in fact, in terms of  $\kappa, \lambda, \mu, \nu$  of § 13, instead of  $w, x, y, z$ ), is given by Cayley (*Camb. and Dub. Math. Journal*, Vol. I. 1846), and completely integrated (in the sense of being reduced to quadratures) by assuming Euler's equations to have been previously integrated. (Compare § 27.)

Cayley's method may be even more easily applied to the above equations than to his own; and I therefore leave this part of the development to the reader, who will at once see (as in § 27) that  $\mathfrak{A}, \mathfrak{B}, \mathfrak{C}$  correspond to  $\omega_1, \omega_2, \omega_3$  of the  $\eta$  type § 23.

29. It may be well to notice, in connection with the formulæ for direction cosines in § 13 above, that we may write

$$\mathfrak{A} = \frac{1}{A} [a(w^2 + x^2 - y^2 - z^2) + 2b(xy + wz) + 2c(xz - wy)],$$

$$\mathfrak{B} = \frac{1}{B} [2a(xy - wz) + b(w^2 - x^2 + y^2 - z^2) + 2c(yz + wx)],$$

$$\mathfrak{C} = \frac{1}{C} [2a(xz + wy) + 2b(yz - wx) + c(w^2 - x^2 - y^2 + z^2)].$$

These expressions may be considerably simplified by the usual assumption, that one of the fixed unit-vectors (*i* suppose) is perpendicular to the invariable plane, which amounts to assigning definitely the initial position of one line in the body; and which gives the relations

$$b = 0, \quad c = 0.$$

30. When forces act,  $\gamma$  is variable, and the quantities  $a, b, c$  will in general involve all the variables  $w, x, y, z, t$ , so that the equations of last section become much more complicated. The type, however, remains the same if  $\gamma$  involves  $t$  only; if it involve  $q$  we must differentiate the equation, put in the form

$$\gamma = 2q\phi(q^{-1}\dot{q})q^{-1},$$

and we thus easily obtain the differential equation of the second order

$$\psi = 4V. \dot{q}\phi (q^{-1}\dot{q}) q^{-1} + 2q\phi (V. q^{-1}\ddot{q}) q^{-1};$$

if we recollect that, because  $q^{-1}\dot{q}$  is a vector, we have

$$S. q^{-1}\ddot{q} = (q^{-1}\dot{q})^2.$$

Though remarkably simple, this formula, in the present state of the development of quaternions, must be looked on as intractable, except in certain very particular cases.

31. Instead of solving the *differential* equation (7) of the group in § 21, having previously eliminated  $\eta$  from it by means of the other two, we may solve the second equation of the group,

$$\gamma q = q\zeta \dots\dots\dots (17),$$

for  $q$ , and treat  $\eta$  as known in terms of  $\zeta$ .  $\zeta$ , of course, is to be regarded as found by the processes of §§ 23, 25. As this mode of attack leads to a determination of  $q$  by a set of three new differential equations, instead of the four of § 27, it may be useful to consider it briefly, but only for the case of  $\gamma = \text{constant}$ . Its interest seems to be derived entirely from the quaternion investigation to which it leads.

32. In consequence of (17), just cited, we may write

$$q = \gamma\delta + \delta\zeta \dots\dots\dots (25),$$

which will be found to satisfy that equation, whatever value is assigned to  $\delta$ .

But  $\delta$  is really not unrestricted in value; for, if we exhibit it as the sum of two vectors, thus

$$\delta = \delta_1 + \delta_2,$$

of which  $\delta_2$  satisfies the equation  $\gamma\delta_2 + \delta_2\zeta = 0$ ,

or, which is the same thing, the pair

$$\left. \begin{aligned} S\delta_2(\gamma + \zeta) &= 0 \\ V\delta_2(\gamma - \zeta) &= 0 \end{aligned} \right\}$$

we see that

$$\delta_2 \parallel \gamma - \zeta$$

satisfies both. [This depends on the fact that  $T\zeta = T\gamma$ .] Hence  $\delta$  must be deprived of its resolved part parallel to  $\gamma - \zeta$ : or we must have

$$S\delta(\gamma - \zeta) = 0 \dots\dots\dots (26).$$

33. By differentiation of (25) we have

$$\dot{q} = \gamma\dot{\delta} + \dot{\delta}\zeta + \delta\dot{\zeta}.$$

Substituting in (7) we have

$$2(\gamma\dot{\delta} + \dot{\delta}\zeta + \delta\dot{\zeta}) = \gamma\delta\eta + \delta\zeta\eta.$$



But, § 22,  $\dot{\zeta} = V\zeta\eta$ ,  
whence  $\zeta\eta - 2\dot{\zeta} = \eta\zeta$ ,

and the above equation becomes

$$2(\gamma\dot{\delta} + \dot{\delta}\zeta) = \gamma\delta\eta + \delta\eta\zeta \dots\dots\dots(27),$$

of which a particular solution is evidently

$$2\dot{\delta} = \delta\eta.$$

But this must be completed by the addition (to the second member) of a solution of the equation

$$\gamma r + r\zeta = 0,$$

since any such term in the value of  $\dot{\delta}$  would disappear from the differential equation.

Such a solution is easily found, by putting  $-\zeta$  for  $\zeta$  in (17), and attending to § 32, in the form

$$r = \gamma\Delta - \Delta\zeta \dots\dots\dots(28),$$

with (as in § 32) the condition  $S(\gamma + \zeta)\Delta = 0 \dots\dots\dots(29).$

Hence, finally,  $2\dot{\delta} = \delta\eta + \gamma\Delta - \Delta\zeta \dots\dots\dots(30),$

which, by taking the scalar, gives

$$S(\gamma - \zeta)\Delta = -S\delta\eta \dots\dots\dots(31).$$

34. By differentiation of (26) we have

$$S(\gamma - \zeta)\dot{\delta} = S\delta\dot{\zeta} = S \cdot \delta\zeta\eta.$$

Substituting the value of  $\dot{\delta}$  from (30) we have

$$S \cdot (\gamma - \zeta)\delta\eta + 2S \cdot \gamma\zeta\Delta = 2S \cdot \delta\zeta\eta,$$

or  $2S \cdot \gamma\zeta\Delta = -S \cdot (\gamma + \zeta)\delta\eta \dots\dots\dots(32).$

From (29), (31), and (32), we find  $\Delta$  by the usual quaternion process in the form

$$2\Delta S \cdot (\gamma - \zeta)(\gamma + \zeta)V\gamma\zeta = -V(\gamma - \zeta)(\gamma + \zeta)S \cdot (\gamma + \zeta)\delta\eta - 2V \cdot (\gamma + \zeta)V\gamma\zeta S\delta\eta,$$

or  $2\Delta V^2\gamma\zeta = -V\gamma\zeta S \cdot (\gamma + \zeta)\delta\eta + (\gamma - \zeta)(\gamma^2 + S\gamma\zeta)S\delta\eta \dots\dots\dots(33),$

where, in transforming the last term, we must recollect the equation  $T\zeta = T\gamma$ .

From this we deduce at once

$$2(\gamma\Delta - \Delta\zeta)V^2\gamma\zeta = -(\gamma V\gamma\zeta - V\gamma\zeta \cdot \zeta)S \cdot (\gamma + \zeta)\delta\eta + [\gamma(\gamma - \zeta) - (\gamma - \zeta)\zeta](\gamma^2 + S\gamma\zeta)S\delta\eta,$$

or  $2(\gamma\Delta - \Delta\zeta)V^2\gamma\zeta = (\gamma - \zeta)(\gamma^2 + S\gamma\zeta)S \cdot (\gamma + \zeta)\delta\eta + 2(\gamma^2 - \gamma\zeta)(\gamma^2 + S\gamma\zeta)S\delta\eta,$

or, finally, remembering that

$$V^2\gamma\zeta = S^2\gamma\zeta - \gamma^2\zeta^2 = S^2\gamma\zeta - \gamma^4,$$

$$2(\gamma\Delta - \Delta\zeta)(S\gamma\zeta - \gamma^2) = (\gamma - \zeta)S \cdot (\gamma + \zeta)\delta\eta + 2(\gamma^2 - \gamma\zeta)S\delta\eta.$$

35. Substituting this in (30), we get, after a slight transformation, consisting in omitting the scalar parts of the right-hand side, whose sum is zero,

$$2\dot{\delta}(S\gamma\zeta - \gamma^2) = (S\gamma\zeta - \gamma^2) V\delta\eta + \frac{1}{2}(\gamma - \zeta)S \cdot (\gamma + \zeta)\delta\eta - V\gamma\zeta S\delta\eta.$$

This may easily be put in the simpler form

$$2\dot{\delta} = V\delta\eta - V \cdot (\gamma + \zeta) V \cdot (\gamma - \zeta)^{-1} \eta\delta \dots \dots \dots (34).$$

Reduced to scalars, this gives three *linear* differential equations of the first order, the coefficients being functions of *t*. These can, of course, be reduced to depend upon one linear differential equation of the third order with coefficients functions of *t*.

36. As a verification of the preceding work, we may try whether the result is consistent, as it ought to be, with the condition (assumed throughout)

$$\text{Constant} = (Tq)^2 = 2\gamma^2\delta^2 + 2S \cdot \gamma\delta\zeta\delta.$$

This expression gives, by differentiation,

$$0 = -\delta^2 S\gamma\dot{\zeta} + 2(\gamma^2 - S\gamma\zeta) S\delta\dot{\delta} + 4S\gamma\delta S\gamma\dot{\delta}.$$

Substituting for  $\dot{\delta}$  its value from (34), we have

$$\begin{aligned} 0 &= -\delta^2 S\gamma\dot{\zeta} + S \cdot \delta\gamma\zeta S\delta\eta + 2S\gamma\delta (S \cdot \gamma\delta\eta - \frac{1}{2}S \cdot (\gamma + \zeta)\delta\eta) \\ &= -\delta^2 S\gamma\dot{\zeta} + S \cdot \delta\gamma\zeta S\delta\eta + S\gamma\delta S \cdot \gamma\delta\eta - S\gamma\delta S \cdot \zeta\delta\eta \\ &= -\delta^2 S\gamma\dot{\zeta} + S \cdot \delta \{ \eta S \cdot \gamma\zeta\delta + \zeta S \cdot \eta\gamma\delta + \gamma S \cdot \zeta\eta\delta \} \\ &= -\delta^2 S\gamma\dot{\zeta} + S \cdot \delta (\delta S \cdot \gamma\zeta\eta) \end{aligned}$$

which is true, because by (20)  $\dot{\zeta} = V\zeta\eta$ .

37. Another mode of attacking the problem, at first sight entirely different from that in § 19, but in reality identical with it, is to seek the linear and vector function which expresses the *Homogeneous Strain* which the body must undergo to pass from its initial position to its position at time *t*.

Let  $\varpi = \chi\alpha$

$\alpha$  being (as in § 19) the initial position of a vector of the body,  $\varpi$  its position at time *t*. In this case  $\chi$  is a linear and vector function. (*Quaternions*, § 355 [3rd ed. § 376].)

Then, obviously, we have,  $\varpi_1$  being the vector of some other point, which had initially the value  $\alpha_1$ ,

$$S\varpi\varpi_1 = S \cdot \chi\alpha\chi\alpha_1 = S\alpha\alpha_1$$

(a particular case of which is  $T\varpi = T\chi\alpha = T\alpha$ )

and  $V\varpi\varpi_1 = V \cdot \chi\alpha\chi\alpha_1 = \chi V\alpha\alpha_1.$

These are necessary properties of the strain-function  $\chi$ , depending on the fact that in the present application the system is rigid.

38. The kinematical equation  $\dot{\omega} = V\epsilon\omega$   
 becomes  $\dot{\chi}\alpha = V\epsilon\chi\alpha$ ,

(the function  $\dot{\chi}$  being formed from  $\chi$  by the differentiation of its constituents with respect to  $t$ ).

Hamilton's kinetic equation  $\Sigma m\omega V\epsilon\omega = \gamma$ ,  
 becomes  $\Sigma . m\chi\alpha V\epsilon\chi\alpha = \gamma$ .

This may be written  $\Sigma . m(\chi\alpha S\epsilon\chi\alpha - \epsilon\alpha^2) = \gamma$ ,  
 or  $\Sigma . m(\alpha S\alpha\chi'\epsilon - \chi^{-1}\epsilon . \alpha^2) = \chi^{-1}\gamma$ ,  
 where  $\chi'$  is the conjugate of  $\chi$ .

But, because  $S\chi\alpha\chi\alpha_1 = S\alpha\alpha_1$ ,  
 we have  $S\alpha\alpha_1 = S\alpha\chi'\chi\alpha_1$ ,  
 whatever be  $\alpha$  and  $\alpha_1$ , so that  $\chi' = \chi^{-1}$ .

Hence  $\Sigma . m(\alpha S\alpha\chi^{-1}\epsilon - \chi^{-1}\epsilon . \alpha^2) = \chi^{-1}\gamma$ ,  
 or, by § 19,  $\phi\chi^{-1}\epsilon = \chi^{-1}\gamma$ .

39. Thus we have, as the analogues of (17), (17'), the equations

$$\chi^{-1}\epsilon = \eta,$$

$$\chi^{-1}\gamma = \zeta,$$

and the former result  $\dot{\chi}\alpha = V\epsilon\chi\alpha$   
 becomes  $\dot{\chi}\alpha = V\chi\eta\chi\alpha = \chi V\eta\alpha$ .

This is our equation to determine  $\chi$ ,  $\eta$  being supposed known. To find  $\eta$  we may remark that

$$\phi\eta = \zeta$$

and  $\dot{\zeta} = \widehat{\chi^{-1}}\gamma$ .

But  $\chi\chi^{-1}\alpha = \alpha$ ,

so that  $\dot{\chi}\chi^{-1}\alpha + \chi\widehat{\chi^{-1}}\alpha = 0$ .

Hence  $\dot{\zeta} = -\chi^{-1}\dot{\chi}\chi^{-1}\gamma$   
 $= -V\eta\chi^{-1}\gamma = V\zeta\eta = V\zeta\phi^{-1}\zeta$ ,

or  $\phi\dot{\eta} = -V\eta\phi\eta$ .

These are the equations we obtained before. Having found  $\eta$  from the last we have to find  $\chi$  from the condition

$$\chi^{-1} \dot{\chi} \alpha = V \eta \alpha.$$

40. We might, however, have eliminated  $\eta$  so as to obtain an equation containing  $\chi$  alone, and corresponding to that of § 21. For this purpose we have

$$\eta = \phi^{-1} \zeta = \phi^{-1} \chi^{-1} \gamma,$$

so that, finally,

$$\chi^{-1} \dot{\chi} \alpha = V \phi^{-1} \chi^{-1} \gamma \alpha,$$

or

$$\widehat{\chi^{-1}} \alpha = V \chi^{-1} \alpha \phi^{-1} \dot{\chi}^{-1} \gamma,$$

which may easily be formed from the preceding equation by putting  $\chi^{-1} \alpha$  for  $\alpha$ , and attending to the value of  $\widehat{\chi^{-1}}$  given in last section.

41. We have given this process, though really a disguised form of that in §§ 19, 21, and though the final equations to which it leads are not quite so easily attacked in the way of integration as those there arrived at, mainly to show how free a use we can make of symbolic functional operators in quaternions without risk of error. It would be very interesting, however, to have the problem worked out afresh from this point of view by the help of the old analytical methods: as several new forms of long-known equations, and some useful transformations, would certainly be obtained.

42. As a verification, let us now try to pass from the final equation, in  $\chi$  alone, of § 40 to that of § 21 in  $q$  alone.

$$\text{We have, obviously,} \quad \varpi = q \alpha q^{-1} = \chi \alpha$$

which gives the relation between  $q$  and  $\chi$ .

[It shows, for instance, that, as ( $\beta$  being any vector whatever)

$$S \beta \chi \alpha = S \alpha \chi' \beta,$$

while

$$S \beta \chi \alpha = S \beta q \alpha q^{-1} = S \alpha q^{-1} \beta q,$$

we have

$$\chi' \beta = q^{-1} \beta q,$$

and therefore that

$$\chi \chi' \beta = q (q^{-1} \beta q) q^{-1} = \beta,$$

or

$$\chi' = \chi^{-1}, \text{ as above.}]$$

Differentiating, we have

$$\dot{q} \alpha q^{-1} - q \alpha q^{-1} \dot{q} q^{-1} = \dot{\chi} \alpha.$$

Hence

$$\begin{aligned} \chi^{-1} \dot{\chi} \alpha &= q^{-1} \dot{q} \alpha - \alpha q^{-1} \dot{q} \\ &= 2V \cdot V(q^{-1} \dot{q}) \alpha. \end{aligned}$$

Also  $\phi^{-1} \chi^{-1} \gamma = \phi^{-1} (q^{-1} \gamma q)$ ,

so that the equation of § 40 becomes

$$2V \cdot V(q^{-1} \dot{q}) \alpha = V \cdot \phi^{-1} (q^{-1} \gamma q) \alpha,$$

or, as  $\alpha$  may have any value whatever,

$$2Vq^{-1} \dot{q} = \phi^{-1} (q^{-1} \gamma q),$$

which, if we put  $Tq = \text{constant}$

as was originally assumed, may be written

$$2\dot{q} = q\phi^{-1} (q^{-1} \gamma q)$$

as in § 21.

43. Let  $\rho$  be the vector joining the extremity of  $\epsilon$  to the intersection of  $\gamma$  with the invariable plane. Then

$$\rho + x\gamma = \epsilon.$$

Operating by  $S \cdot \gamma$ , and remembering the condition

$$S\epsilon\gamma = -h^2,$$

we have

$$x\gamma^2 = -h^2;$$

so that

$$\rho = \epsilon + \frac{h^2}{\gamma^2} \gamma.$$

In the initial position of the body this vector, considered as being drawn from the fixed point, was

$$\begin{aligned} \sigma &= q^{-1} \epsilon q + \frac{h^2}{\gamma^2} q^{-1} \gamma q \\ &= \eta + \frac{h^2}{\gamma^2} \zeta \\ &= \left( \phi^{-1} + \frac{h^2}{\gamma^2} \right) \zeta. \end{aligned}$$

In the initial position of the body, therefore, this vector passes through the intersection of the ellipsoid

$$S \left( \phi^{-1} + \frac{h^2}{\gamma^2} \right)^{-1} \sigma \phi^{-1} \left( \phi^{-1} + \frac{h^2}{\gamma^2} \right)^{-1} \sigma = S\zeta\eta = -h^2,$$

with a second ellipsoid  $T \left( \phi^{-1} + \frac{h^2}{\gamma^2} \right)^{-1} \sigma = T\zeta = T\gamma.$

It therefore lies on the cone

$$\gamma^2 S \left( \phi^{-1} + \frac{h^2}{\gamma^2} \right)^{-1} \sigma \phi^{-1} \left( \phi^{-1} + \frac{h^2}{\gamma^2} \right)^{-1} \sigma + h^2 S \left( \phi^{-1} + \frac{h^2}{\gamma^2} \right)^{-1} \sigma \left( \phi^{-1} + \frac{h^2}{\gamma^2} \right)^{-1} \sigma = 0,$$

or 
$$S\sigma \left( \phi^{-1} + \frac{h^2}{\gamma^2} \right)^{-1} \sigma = 0.$$

[We might have saved the last seven lines by noticing that

$$S\gamma\rho = 0$$

in the present position of the body, involves

$$S\zeta\sigma = 0$$

in the initial state, which, with the value of  $\zeta$  in terms of  $\sigma$  above, gives the result at once.]

44. This cone is seen at once to be normal to the  $\zeta$ -cone in the initial body, viz., by § 26,

$$S\zeta\phi^{-1}\zeta = -\frac{h^2}{\gamma^2}\zeta^2,$$

or 
$$S\zeta \left( \phi^{-1} + \frac{h^2}{\gamma^2} \right) \zeta = 0^*.$$

The vector  $\sigma$  constantly changes so as to be perpendicular to  $\zeta$ . Hence in the moving body, the vector  $\rho$ , which is always in the plane through the fixed point and perpendicular to  $\gamma$ , belongs to a cone of which  $\gamma$  is a normal, and which therefore *rolls* on that plane. But the cone also *slides*, because the vector  $\rho$  which is in contact with the plane is not the instantaneous axis of the body. This construction for the illustration of the motion is also due to Poinso, and the complete analytical solution of the problem has been given, from this point of view, by Rueb and Jacobi†. It is easy to see that the angular velocity of the sliding motion is the *constant* resolved angular velocity of the body about the fixed line  $\gamma$ , which has the value

$$-S\epsilon U\gamma = \frac{h^2}{T\gamma}.$$

45. When two of the moments of inertia of the rigid body are equal, *i.e.* when the symbolical cubic in  $\phi$  or  $\varphi$  has two equal roots, all the previous dynamical work

\* In fact any equation such as 
$$S\rho\psi\rho=0,$$

where  $\psi$  is a constant self-conjugate linear and vector function, gives

$$S\psi\rho d\rho=0,$$

whence

$$\nu=\psi\rho$$

where  $\nu$  represents the normal-vector. For its locus, we have

$$\rho=\psi^{-1}\nu,$$

and by substitution for  $\rho$  and  $\psi\rho$  in the given equation, we have

$$S\nu\psi^{-1}\nu=0.$$

† See Cayley, *B. A. Report*, 1862.

becomes immensely simplified. In fact, if we now take  $\alpha, \beta, \gamma$  as unit-vectors coinciding with the principal axes of the moving body, we have by (23)

$$\varphi\rho = -A\alpha S\alpha\rho - B\beta S\beta\rho - B\gamma S\gamma\rho.$$

But 
$$\rho = -\alpha S\alpha\rho - \beta S\beta\rho - \gamma S\gamma\rho,$$

so that 
$$\varphi\rho = B\rho - (A - B)\alpha S\alpha\rho \dots\dots\dots(35),$$

and thus depends upon the position of the *one* vector  $\alpha$ . We may attempt to determine the motion without at first introducing the consideration of the quaternion which has been our principal object of study in this paper.

46. The general equation of § 24

$$\varphi\dot{\epsilon} = -V\epsilon\varphi\epsilon$$

becomes, by substituting for  $\varphi$  from (35),

$$B\dot{\epsilon} - (A - B)\alpha S\alpha\dot{\epsilon} = -(A - B)V\alpha\epsilon S\alpha\epsilon\dots\dots\dots(36).$$

Operating by  $S.\alpha$ , we have 
$$S\alpha\dot{\epsilon} = 0 \dots\dots\dots(37).$$

Omitting, therefore, this term from (36) and operating by  $S.\epsilon$ , we have

$$S\epsilon\dot{\epsilon} = 0,$$

whose integral is 
$$\epsilon^2 = \text{constant} = -\Omega^2, \text{ suppose } \dots\dots\dots(38).$$

But we have always by § 1

$$\dot{\alpha} = V\epsilon\alpha,$$

because  $\alpha$  is fixed in the body.

From this we see that 
$$S\epsilon\dot{\alpha} = 0.$$

This, taken in conjunction with (37), gives

$$S\alpha\dot{\epsilon} + S\epsilon\dot{\alpha} = 0,$$

whose integral is 
$$S\alpha\epsilon = \text{constant}, = -\Omega \cos \beta, \text{ suppose } \dots\dots\dots(39).$$

Equation (36) may now be written

$$B\dot{\epsilon} = -(A - B)\Omega\dot{\alpha} \cos \beta,$$

or 
$$B\epsilon = -(A - B)\Omega\alpha \cos \beta + \text{constant vector}.$$

But we have always, by (14), (see § 24)

$$\varphi\epsilon = \gamma,$$

or, by (35), (36), (39), 
$$B\epsilon + (A - B)\alpha\Omega \cos \beta = \gamma\dots\dots\dots(40).$$

So that the constant vector is  $\gamma$ .

Thus we see that  $\alpha$  and  $\epsilon$  are always coplanar with  $\gamma$ , and that each remains constantly at the same inclination to it.

47. Operating on (40) by  $S \cdot \epsilon$ ,  $S \cdot \alpha$ ,  $S \cdot \gamma$ , respectively, we have

$$\begin{aligned} -B\Omega^2 - (A - B)\Omega^2 \cos^2 \beta &= -h^2, \\ -B\Omega \cos \beta - (A - B)\Omega \cos \beta &= S\alpha\gamma, \\ -Bl^2 + (A - B)S\alpha\gamma \Omega \cos \beta &= \gamma^2, \end{aligned}$$

and these give, in order,

$$\begin{aligned} (A \cos^2 \beta + B \sin^2 \beta) \Omega^2 &= h^2, \\ -A\Omega \cos \beta &= S\alpha\gamma, \\ -(A^2 \cos^2 \beta + B^2 \sin^2 \beta) \Omega^2 &= \gamma^2. \end{aligned}$$

The first and third determine  $\beta$  and  $\Omega$  in terms of the given constants  $h$  and  $T\gamma$ , and the second gives the value of the constant inclination of  $\alpha$  to the fixed line  $\gamma$ .

Introducing  $-\alpha^2$ , which is unity, as a multiplier of  $\gamma^2$  in the third equation, and adding to its members the squares of the corresponding members of the second, we have

$$-B^2\Omega^2 \sin^2 \beta = V^2\alpha\gamma.$$

48. We get equations immediately derivable from these by seeking at once the equations of the fixed and rolling cones, by which the motion may be exhibited. Thus the locus of  $\epsilon$  in the body, *i.e.*, the rolling cone, has by (14) and (38) the equation

$$\Omega T\zeta\epsilon = T\gamma T\epsilon,$$

which may be transformed as follows—

$$\begin{aligned} \Omega^2 \{B^2\epsilon^2 - 2B(A - B)S^2\alpha\epsilon - (A - B)^2S^2\alpha\epsilon\} &= -\gamma^2\epsilon^2, \\ \Omega^2 (B^2\epsilon^2 - (A^2 - B^2)S^2\alpha\epsilon) &= -\gamma^2\epsilon^2, \\ (B^2\Omega^2 + \gamma^2)\epsilon^2 - (A^2 - B^2)\Omega^2 S^2\alpha\epsilon &= 0, \end{aligned}$$

and finally

$$\epsilon^2 \cos^2 \beta + S^2\alpha\epsilon = 0.$$

This might have been written down at once by inspection of (38) and (39).

The locus of  $\epsilon$  in space, *i.e.*, the fixed cone, has the equation

$$S^2\gamma\epsilon + \frac{h^4}{\Omega^2}\epsilon^2 = 0.$$

49. In the preceding solution we began with the very simple equation for  $\epsilon$ , which immediately presented itself. Let us now apply to the same problem the general equation of § 21, *viz.*,

$$2\dot{q} = q\phi^{-1}(q^{-1}\gamma q).$$



Here, of course, we have

$$\begin{aligned}\phi^{-1}\rho &= -\frac{1}{A}iSi\rho - \frac{1}{B}jSj\rho - \frac{1}{B}kSk\rho, \\ &= \left(\frac{1}{B} - \frac{1}{A}\right)iSi\rho + \frac{\rho}{B}.\end{aligned}$$

Hence

$$2\dot{q} = q \left\{ \left(\frac{1}{B} - \frac{1}{A}\right)iS \cdot iq^{-1}\gamma q + \frac{1}{B}q^{-1}\gamma q \right\}$$

which, because

$$\alpha = qi q^{-1},$$

becomes

$$\epsilon = 2\dot{q}q^{-1} = \left(\frac{1}{B} - \frac{1}{A}\right)\alpha S\alpha\gamma + \frac{1}{B}\gamma$$

which is (40) of § 46, as we see by substituting for  $S\alpha\gamma$  from § 47.

50. Employing this value of  $\epsilon$  in the kinetic equation

$$\dot{\alpha} = V\epsilon\alpha,$$

we have

$$\dot{\alpha} = -\frac{1}{B}V\gamma\alpha.$$

Hence

$$\begin{aligned}\ddot{\alpha} &= -\frac{1}{B}V\gamma\dot{\alpha} = \frac{1}{B^2}V \cdot \gamma V\gamma\alpha \\ &= \frac{\gamma^2}{B^2}\alpha - \frac{\gamma}{B^2}S\alpha\gamma,\end{aligned}$$

of which the integral is obviously

$$\alpha = \gamma^{-1}S\alpha\gamma + \kappa \cos \frac{T\gamma}{B}t + \lambda \sin \frac{T\gamma}{B}t,$$

where  $\kappa$  and  $\lambda$  are vector constants of integration.

The two last terms must be, together, equal to

$$\gamma^{-1}V\gamma\alpha,$$

and, as they vanish alternately, the tensors of  $\kappa$  and  $\lambda$  must be equal. Also unless

$$S\kappa\lambda = 0$$

the tensor of this part of  $\alpha$  will vary. Hence

$$\alpha = -U\gamma S\alpha U\gamma + TV\alpha U\gamma \cdot \left( U\kappa \cos \frac{T\gamma}{B}t + U\lambda \sin \frac{T\gamma}{B}t \right).$$

Let us, for simplicity, take the usual  $i, j, k$  of quaternions as coinciding with  $U\gamma, U\kappa, U\lambda$ , and let

$$-S\alpha U\gamma = \cos \beta.$$

Then  $TV\alpha U\gamma = \sin \beta.$

Also let  $\frac{T\gamma}{B} = n.$

Thus we have  $\alpha = i \cos \beta + (j \cos nt + k \sin nt) \sin \beta$   
whence

$$2\dot{q}q^{-1} = -\left(\frac{1}{B} - \frac{1}{A}\right)nB \cos \beta [i \cos \beta + (j \cos nt + k \sin nt) \sin \beta] + ni$$

$$= 2ai + 2b(j \cos nt + k \sin nt),$$

where  $2b = -nB\left(\frac{1}{B} - \frac{1}{A}\right) \cos \beta \sin \beta$

$$2a = -nB\left(\frac{1}{B} - \frac{1}{A}\right) \cos^2 \beta + n = n\left(\sin^2 \beta + \frac{B}{A} \cos^2 \beta\right).$$

51. For the complete solution of the problem, it remains that we integrate the equation above, which we may write as

$$\dot{q} = [ai + b(j \cos nt + k \sin nt)]q$$

$$= (ai + b\varpi)q \dots\dots\dots (41),$$

if we put  $\varpi = j \cos nt + k \sin nt.$

This gives at once the following results, which are necessary in the elimination of  $\varpi$  by differentiation,

$$\varpi^2 = -1, \quad \dot{\varpi} = ni\varpi,$$

$$\varpi\dot{\varpi} = ni, \quad i\dot{\varpi} = -n\varpi,$$

$$\ddot{\varpi} = -n^2\varpi.$$

Also, because  $Si\varpi = 0,$

we have  $(ai + b\varpi)^2 = -(a^2 + b^2).$

Differentiating (41), and simplifying at every step by the above auxiliary equations, we have

$$\dot{q} = (ai + b\varpi)q$$

$$\ddot{q} = -(a^2 + b^2)q + b\dot{\varpi}q$$

$$\dot{\dot{q}} = -(a^2 + b^2)\dot{q} - bn^2\varpi q + bn(a\varpi - bi)q$$

$$\ddot{\dot{q}} = -(a^2 + b^2)\ddot{q} - (bn^2 - bna)\dot{\varpi}q + (bn^2 - bna)\left(\frac{a}{n}\dot{\varpi} + b\right)q - b^2n\left(-a + \frac{b}{n}\dot{\varpi}\right)q$$

$$= -(a^2 + b^2)\ddot{q} - (bn^2 - 2bna + ba^2 + b^3)\dot{\varpi}q + b^2n^2q.$$

Eliminating  $\dot{\varpi}q$  from the last equation by means of the second, we have for the determination of  $q$  the linear equation of the fourth order with constant coefficients

$$\ddot{\dot{q}} + [2(a^2 + b^2) + n^2 - 2na]\dot{q} + [(a^2 + b^2)^2 + (a^2 + b^2)(n^2 - 2na) - b^2n^2]q = 0 \dots\dots (42).$$

Assume, as a particular integral,  $q = Q\epsilon^{mt}$ ,

where  $Q$  is an arbitrary, but constant, quaternion, and  $\epsilon$  is the base of Napier's Logarithms. Then we find for  $m$  the equation

$$m^4 + [2(a^2 + b^2) + n^2 - 2na]m^2 + (a^2 + b^2 - na)^2 = 0,$$

or 
$$m^2 + a^2 + b^2 - na = \pm \sqrt{-m^2n^2}.$$

Hence  $m$  is imaginary, so we may write

$$m = \mu \sqrt{-1},$$

and our equation gives 
$$\mu^2 \pm \mu n = a^2 + b^2 - na,$$

whence 
$$\mu = \pm \frac{n}{2} \pm \sqrt{\left(a - \frac{n}{2}\right)^2 + b^2}.$$

By § 50 this may be written

$$\mu = \pm \frac{T\gamma}{2B} \left\{ 1 \pm \left(1 - \frac{B}{A}\right) \cos \beta \right\} \dots\dots\dots (43).$$

These values may be called  $\pm \mu_1, \pm \mu_2$ , and we have

$$\mu_1 + \mu_2 = n.$$

52. The complete solution of the equation (42) is therefore

$$q = Q_1 \cos \mu_1 t + Q_2 \sin \mu_1 t + Q_3 \cos \mu_2 t + Q_4 \sin \mu_2 t.$$

This, however, is far too general for the solution of the original problem, for it involves *sixteen* arbitrary constants instead of *four*. But it is a mere piece of ordinary analysis to find twelve of these in terms of the other four.

Thus, let us write

$$\begin{aligned} Q_1 &= H_1 + I_1 i + J_1 j + K_1 k, \\ Q_2 &= H_2 + I_2 i + J_2 j + K_2 k, \\ Q_3 &= H_3 + I_3 i + J_3 j + K_3 k, \\ Q_4 &= H_4 + I_4 i + J_4 j + K_4 k. \end{aligned}$$

If these values be substituted in the above expression for  $q$ , and the resulting value of  $q$  be used in the equation

$$\dot{q} = [ai + b(j \cos nt + k \sin nt)] q,$$

we find, on replacing *products* of sines and cosines of multiples of  $t$  by *sums* of sines or cosines, two sets of terms. One of these is of the type

$$\cos(n - \mu_1) t,$$

which, being equal to

$$\cos \mu_2 t,$$

may be allowed to remain in the equation. The other set is of the type

$$\cos(n + \mu_1)t,$$

and the terms introducing it must vanish identically.

This consideration gives us the following relations among the sixteen constants above

$$I_2 = H_1, \quad H_2 = -I_1, \quad J_2 = -K_1, \quad K_2 = J_1,$$

$$I_4 = H_3, \quad H_4 = -I_3, \quad J_4 = -K_3, \quad K_4 = J_3;$$

so that the values of eight are assigned in terms of the remainder.

Next, by equating coefficients of each such distinct term as

$$i \cos \mu_1 t, \quad k \sin \mu_2 t, \quad \&c.,$$

we obtain sixteen additional equations, of which, however, eight are mere repetitions of the other eight. Rejecting them, we find the remainder to be

$$bH_3 = (a - \mu_1)K_1 \qquad bK_1 = -(a - \mu_2)H_3$$

$$bI_3 = (a - \mu_1)J_1 \qquad bJ_1 = -(a - \mu_2)I_3$$

$$bJ_3 = -(a - \mu_1)I_1 \qquad bI_1 = (a - \mu_2)J_3$$

$$bK_3 = -(a - \mu_1)H_1 \qquad bH_1 = (a - \mu_2)K_3.$$

These are, again, identical in pairs; for each pair containing the same two constants agree with the others in giving

$$\frac{a - \mu_1}{-b} = \frac{b}{a - \mu_2},$$

or

$$a^2 + b^2 - (\mu_1 + \mu_2)a + \mu_1\mu_2 = 0.$$

But, by (43), we have

$$\mu_1 + \mu_2 = n$$

$$\mu_1\mu_2 = \frac{n^2}{4} - \left(a - \frac{n}{2}\right)^2 - b^2$$

and the condition is satisfied identically.

The final value of the quaternion in the case of the uniform rolling of one right cone on another is therefore

$$q = (H_1 + I_1i + J_1j + K_1k) \cos \mu_1 t \\ - (I_1 - H_1i + K_1j - J_1k) \sin \mu_1 t$$

$$\begin{aligned}
 & + \frac{a - \mu_1}{b} (K_1 + J_1 i - I_1 j - H_1 k) \cos \mu_2 t \\
 & - \frac{a - \mu_1}{b} (J_1 - K_1 i - H_1 j + I_1 k) \sin \mu_2 t^*.
 \end{aligned}$$

Putting  $q = w + ix + jy + kz,$

the ordinary differential equations, corresponding to that just solved, are

$$\begin{aligned}
 \dot{w} &= -ax - by \cos nt - bz \sin nt, \\
 \dot{x} &= aw + bz \cos nt - by \sin nt, \\
 \dot{y} &= bw \cos nt + bx \sin nt - az, \\
 \dot{z} &= bw \sin nt + ay - bx \cos nt.
 \end{aligned}$$

By substitution in these the above result may be verified.

53. Consider, as an example of applied forces, a homogeneous solid of revolution moving about a fixed point in its axis, which is not its centre of gravity. To determine the motion.

If  $\alpha$ , a unit-vector, represent at time  $t$  the position of the axis of the solid, we may choose the tensor of  $\gamma$ , a vertical vector, so that the couple due to gravity is  $V\alpha\gamma$ . Hence the equation of motion is, §§ 24, 22,

$$\phi \dot{\epsilon} + V\epsilon\phi\epsilon = V\alpha\gamma.$$

But  $\phi\rho = B\rho - (A - B)\alpha S\alpha\rho,$

so that  $B\dot{\epsilon} - (A - B)\alpha S\alpha\dot{\epsilon} - (A - B)V\epsilon\alpha S\alpha\epsilon = V\alpha\gamma \dots \dots \dots (44).$

This, with the kinematical relation

$$\dot{\alpha} = V\epsilon\alpha \dots \dots \dots (1),$$

contains the complete solution of the problem.

\* The tensor of  $q$  has been assumed constant. Accordingly we find by this formula

$$\begin{aligned}
 & \left[ H_1 \cos \mu_1 t - I_1 \sin \mu_1 t + \frac{a - \mu_1}{b} (K_1 \cos \mu_2 t - J_1 \sin \mu_2 t) \right]^2 + \left[ I_1 \cos \mu_1 t + H_1 \sin \mu_1 t + \frac{a - \mu_1}{b} (J_1 \cos \mu_2 t + K_1 \sin \mu_2 t) \right]^2 \\
 & + \left[ J_1 \cos \mu_1 t - K_1 \sin \mu_1 t - \frac{a - \mu_1}{b} (I_1 \cos \mu_2 t - H_1 \sin \mu_2 t) \right]^2 + \left[ K_1 \cos \mu_1 t + J_1 \sin \mu_1 t - \frac{a - \mu_1}{b} (H_1 \cos \mu_2 t + I_1 \sin \mu_2 t) \right]^2 \\
 & = (H_1^2 + I_1^2 + J_1^2 + K_1^2) \left[ 1 + \left( \frac{a - \mu_1}{b} \right)^2 \right] \\
 & = (H_1^2 + I_1^2 + J_1^2 + K_1^2) \left( 1 - \frac{a - \mu_1}{a - \mu_2} \right).
 \end{aligned}$$

54. Operating on (44) by  $S \cdot \alpha$ , we have

$$S\alpha\dot{\epsilon} = 0.$$

But, by (1), we have

$$S\dot{\alpha}\epsilon = 0.$$

Hence

$$S\alpha\epsilon = \text{constant} = \Omega \dots \dots \dots (45)$$

(that is, the angular velocity about the axis of revolution of the solid is constant) and (44) is reduced to the form

$$B\dot{\epsilon} - (A - B)\Omega\dot{\alpha} = V\alpha\gamma \dots \dots \dots (46).$$

But, by (45) and (1),

$$\epsilon\alpha = \Omega + \dot{\alpha},$$

or

$$\epsilon = -\Omega\alpha + \alpha\dot{\alpha} \dots \dots \dots (47).$$

Since  $\alpha\dot{\alpha}$  is a vector, we have (as in § 30)

$$S\alpha\dot{\alpha} = -\dot{\alpha}^2 \dots \dots \dots (48),$$

so that the substitution in (46) of the value of  $\epsilon$  from (47) gives

$$BV\alpha\dot{\alpha} - A\Omega\dot{\alpha} = V\alpha\gamma \dots \dots \dots (49),$$

an extremely simple equation to determine  $\alpha$ . It is curious to remark that this is the equation of motion of a simple pendulum, disturbed by a force constantly perpendicular to the cone described by the string, and proportional to the rate at which the area of the surface of the cone is swept out by the suspending cord. When  $A = 0$  it becomes that of the undisturbed motion\*, and gives a number of curious theorems relating to the curvature of the general path of a simple pendulum. These we need not at present consider; though we may mention that the corresponding equation for the motion of Foucault's pendulum may be written in the form

$$V\alpha(\ddot{\alpha} + \dot{\beta}) = eV\alpha\beta,$$

where  $\beta$  is a vector known in terms of  $t$ .

55. If we suppose  $\alpha$  determined in terms of  $t$  from equation (49), (46) gives  $\epsilon$  in the form

$$B\epsilon = (A - B)\Omega\alpha - V \cdot \gamma \int \alpha dt.$$

This equation may be obtained, even more simply, from (47).

\* If  $m$  be the mass of the pendulum bob,  $a$  the vector representing the string,  $\mathcal{T}$  its tension, and  $\gamma'$  the acceleration due to gravity

$$m\ddot{a} = m\gamma' - \mathcal{T}U_a,$$

or, eliminating  $\mathcal{T}$ ,

$$Va\ddot{a} = V\alpha\gamma'.$$

It is well to observe that this is the equation of motion of a pendulum bob, acted on by no forces, if  $-\gamma'$  be the acceleration of the point of suspension.

56. But, without finding either  $\alpha$  or  $\epsilon$ , we may deduce various facts connected with the motion. Thus operating on (46) by  $S \cdot \epsilon$ , we get

$$BS\epsilon\dot{\epsilon} = S \cdot \epsilon\alpha\dot{\gamma} = S\gamma\dot{\alpha},$$

which gives

$$B\epsilon^2 = 2S\gamma\alpha + C \dots\dots\dots(50).$$

Also, by operating on the same equation by  $S \cdot \gamma$  and integrating, we have

$$BS\gamma\epsilon - (A - B)\Omega S\gamma\alpha = C_1 \dots\dots\dots(51),$$

which may be written in the form

$$S\epsilon\dot{\gamma} = S\gamma\dot{\epsilon} = C_1 \dots\dots\dots(51').$$

By (50) and (51) 
$$B\epsilon^2 = 2 \frac{BS\gamma\epsilon - C_1}{(A - B)\Omega} + C,$$

so that  $\epsilon$  is a vector of a fixed *sphere*, of which however the centre is not at the fixed point.

57. From (49) we have at once, by operating by  $S \cdot \gamma$  and integrating,

$$BS \cdot \gamma\alpha\dot{\alpha} = A\Omega S\gamma\alpha + C' \dots\dots\dots(52).$$

Also, operating by  $S \cdot V\gamma\alpha$ ,

$$BS \cdot \gamma\alpha V\alpha\dot{\alpha} = A\Omega S \cdot \gamma\alpha\dot{\alpha} - (V\alpha\dot{\gamma})^2 \dots\dots\dots(53),$$

or

$$B(-S\gamma\ddot{\alpha} - S\gamma\alpha S\alpha\ddot{\alpha}) = A\Omega S \cdot \gamma\alpha\dot{\alpha} + \alpha^2\dot{\gamma}^2 - S^2\alpha\dot{\gamma} \\ = \frac{A^2\Omega^2}{B} S\gamma\alpha + \frac{A\Omega C'}{B} - \dot{\gamma}^2 - S^2\alpha\dot{\gamma},$$

by (52).

This may be written

$$B \left[ -S\gamma\ddot{\alpha} - S\gamma\alpha \left( -\Omega^2 - \frac{2S\gamma\alpha + C}{B} \right) \right] = \frac{A^2\Omega^2}{B} S\gamma\alpha + \frac{A\Omega C'}{B} - \dot{\gamma}^2 - S^2\alpha\dot{\gamma},$$

which leads, by integration, to the ordinary expression for  $S\gamma\alpha$  in terms of an elliptic function. It is to be observed, however, that this quantity is not one which the quaternion calculus directly points out as an object of research: the propriety of seeking  $\alpha$  in the first place being clearly indicated.

58. From the above equations all the ordinary results connected with this problem may be at once deduced by any one who has a little skill in quaternion analysis: but the determination of the quaternion which gives the position of the body at any time does not appear, so far as I have yet examined the question, to lead to any very simple expressions.

If we could, generally, integrate equation (49),  $\epsilon$  would be at once given by (47)

and the determination of the motion would be reduced to comparative simplicity. The equation for the direct determination of  $\epsilon$  may be formed as follows, but it is not so simple as that for  $\alpha$ .

From the equation

$$B\dot{\epsilon} - (A - B)\Omega V\epsilon\alpha = V\alpha\gamma,$$

we have, by operating by  $V \cdot \epsilon$ , the result

$$BV\epsilon\dot{\epsilon} - (A - B)\Omega(\alpha\epsilon^2 - \epsilon\Omega) = \Omega\gamma - \alpha S\gamma\epsilon,$$

which gives

$$\alpha = \frac{BV\epsilon\dot{\epsilon} + (A - B)\Omega^2\epsilon - \Omega\gamma}{(A - B)\Omega\epsilon^2 - S\gamma\epsilon}.$$

The condition

$$\dot{\alpha} = V\epsilon\alpha$$

gives, by substituting this value of  $\alpha$ ,

$$\begin{aligned} BV\epsilon\ddot{\epsilon} + (A - B)\Omega^2\dot{\epsilon} - \frac{BV\epsilon\dot{\epsilon} + (A - B)\Omega^2\epsilon - \Omega\gamma}{(A - B)\Omega\epsilon^2 - S\gamma\epsilon} \{2(A - B)\Omega S\epsilon\dot{\epsilon} - S\gamma\dot{\epsilon}\} \\ = B(\dot{\epsilon}\epsilon^2 - \epsilon S\epsilon\dot{\epsilon}) - \Omega V\epsilon\gamma. \end{aligned}$$

59. Processes very similar to these may be applied to the motions of the Gyroscope and to Precession and Nutation. I confine myself at present to the formation of the equation for the latter question, reserving for another communication the *details* of the solutions of these three problems; as they involve some curious and delicate points of quaternion analysis.

60. *To form the equation for Precession and Nutation.* Let  $\alpha$  be the vector, from the centre of inertia of the earth, to a particle  $m$  of its mass: and let  $\rho$  be the vector of the disturbing body, whose mass is  $M$ . The vector-couple produced is evidently

$$\begin{aligned} M\Sigma \cdot m V\alpha \frac{U(\rho - \alpha)}{T^2(\rho - \alpha)} \\ = M\Sigma \cdot m \frac{V\alpha\rho}{T^3(\rho - \alpha)} \\ = M\Sigma \cdot \frac{mV\alpha\rho}{T^3\rho} \frac{1}{\left(1 + \frac{2S\alpha\rho}{T^2\rho} + \frac{T^2\alpha}{T^2\rho}\right)^{\frac{3}{2}}} \\ = M\Sigma \cdot \frac{mV\alpha\rho}{T^3\rho} \left(1 - \frac{3S\alpha\rho}{T^2\rho} + \&c.\right), \end{aligned}$$

no farther terms being necessary, since  $\frac{T\alpha}{T\rho}$  is always small in the actual cases presented in nature. But, because  $\alpha$  is measured from the centre of inertia,

$$\Sigma \cdot m\alpha = 0.$$



Also, as in § 19,  $\phi\rho = \Sigma . m(\alpha S\alpha\rho - \alpha^2\rho)$ .

Thus the vector-couple required is

$$\frac{3M}{T^5\rho} V . \rho\phi\rho.$$

Referred to co-ordinates moving with the body,  $\phi$  becomes  $\varphi$  as in § 24, and § 24 gives

$$\varphi\epsilon = \gamma = 3M \int \frac{V . \rho\varphi\rho}{T^5\rho} dt.$$

Introducing the value of  $\varphi$  from § 53—*i.e.*, assuming that the earth has two principal axes of equal moment of inertia, we have

$$B\epsilon - (A - B)\alpha S\alpha\epsilon = 3M(A - B) \int \frac{V\alpha\rho S\alpha\rho}{T^5\rho} dt.$$

This gives, as in § 54,  $S\alpha\epsilon = \text{const.} = \Omega$ ,

whence  $\epsilon = -\Omega\alpha + \alpha\dot{\alpha}$ ,

so that, finally,  $BV\alpha\dot{\alpha} - A\Omega\dot{\alpha} = \frac{3M}{T^5\rho}(A - B)S\alpha\rho V\alpha\rho$ .

The most striking peculiarity of this equation is that the *form* of the solution is entirely changed, not modified as in ordinary cases of disturbed motion, according to the nature of the value of  $\rho$ .

Thus, when the right-hand side vanishes, we have the equation (49) with the restriction that the body moves about its centre of inertia (easily seen to be identical with that at the beginning of § 50); which, in the case of the earth, would represent the rolling of a cone fixed in the earth on one fixed in space, the angles of *both* being exceedingly small.

If  $\rho$  be finite, but constant, we have a case nearly the same as that of the top in §§ 53, 54, the axis on the whole revolving conically about  $\rho$ .

But if we assume the expression

$$\rho = r(j \cos mt + k \sin mt)$$

(which represents a circular orbit described with uniform velocity)  $\alpha$  revolves on the whole conically about the vector  $i$ , perpendicular to the plane in which  $\rho$  lies.

I hope, on a future occasion, to give detailed solutions of these problems, to a sufficient degree of approximation.

## XVI.

## NOTE ON ELECTROLYTIC POLARIZATION.

[*Proceedings of the Royal Society of Edinburgh, May 31, 1869.*]

THE following note refers to some experiments instituted at the request of Mr Dewar, who asked me to determine the polarization of the Palladium electrodes whose singular behaviour he recently described to the Society.

I had just obtained one of Sir W. Thomson's most recent forms of quadrant electrometer, and it occurred to me that *this* must be the proper instrument for determining polarization, as its indications are not affected by electric resistance, and give directly—that is, without assuming the truth of Ohm's law for reverse electromotive forces, and the consequent necessary determinations of resistance—the quantities required. The method employed by Wheatstone, Poggendorff, Buff, and others, assumes that the whole electromotive force in the circuit is the algebraic sum of those of the decomposing battery and of the electrodes,—an assumption whose truth some may consider to require proof, and which it is certainly useful to verify by an independent process. Again, after the decomposing action has ceased, the resistance of the films (of gas or oxide) which are deposited on the electrodes may change in value. That neither of these circumstances produces any marked effect is, however, amply proved by the numbers which follow, which, though given only as first approximations, are within the limits of difference of the results given (from galvanometric determinations) by former experimenters.

The experiments were all made in my laboratory, mainly under my own direction, but sometimes under the eye of my assistant, Mr W. R. Smith. Able assistance was rendered by several of my practical students,—two months ago by Messrs Russell Smith and J. C. Young, more recently by Messrs Browning and Nichol.

As the polarization in most cases diminishes with very great rapidity from the instant of breaking contact with the decomposing battery, and as (for this and other reasons) the mode of measurement by the first swing of the index-needle of the electrometer is not deserving of much confidence, it was necessary to devise a process by which the electrometer could be charged at leisure up to any desired potential, and then, for an instant only, placed in connection with the electrodes. The apparatus I employed bears a certain analogy to the *Wippe* of Poggendorff, but differs from it in some essential particulars, both of construction and mode of working.

In a plate of vulcanite, or other good insulator, ten holes are cut as below, and filled with mercury. Those marked *E* are connected with pairs of opposite

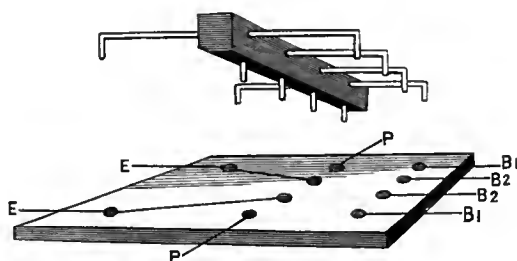

quadrants of the electrometer, *P* with the electrodes, *B<sub>1</sub>* with the decomposing battery, and *B<sub>2</sub>* with the auxiliary (or charging) battery. Also metallic connection, as indicated in the sketch, is permanently established between the two central holes and the holes connected with the electrometer.

The rocker consists of four wires, supported on an insulating bar of vulcanite, the two outermost having three points, the middle one longer than the others, and the two inner being similar, but wanting one of the extremities. When the four middle stems dip vertically into the four central mercury cups, the other stems do not reach the mercury in any of the other six cups. If the instrument be inclined to the right the four prongs enter the holes to the right—thus simultaneously connecting the electrodes with the decomposing battery, and the electrometer with the charging battery. When the instrument inclines to the left, the electrodes are shunted from the decomposing battery on to the electrometer,—the latter having just before, by the same action, been cut off from the charging battery, and thus left charged.

The *modus operandi* is simply this:—Leave the rocker leaning to the right by its own gravity, decomposition and polarization going on; adjust the wires *B<sub>2</sub>* to different points in a wet string (or a narrow canal of water) closing the circuit of the charging battery; work the rocker quickly to the left, and allow it instantly to fall back again,—a process which need not occupy more than a small fraction of a second; yet which must not be performed too quickly, on account of the inertia

(small as it is) of the needle and mirror of the electrometer. If the deflection of the electrometer be suddenly increased or diminished by this action, slide one of the wires  $B_2$  along the wet string, a little farther from or nearer to the other, and rock again,—continuing this process till a charge is found which leaves the electrometer at rest when the rocking to and fro is performed. Reverse a commutator attached to the wires  $E$ , and repeat the operation. The difference of the scale readings in these two cases gives a number proportional to the electromotive force of the polarized plates—(I say *difference*, because the scales commonly used with Sir W. Thomson's instruments are, to avoid confusion, graduated from one end to the other, as they ought to be, instead of being graduated opposite ways from the middle). To enable this measure to be reduced to absolute units, a normal Daniell's cell was applied at intervals, during each day's work, directly to the electrodes of the electrometer, then reversed; and the difference of the readings was tabulated as representing its electromotive force.

In the earlier experiments I used a plate of gutta-percha in which the ten holes were bored, but for a time discontinued its use on suspecting that it sometimes led to irregular working of the apparatus by imperfect insulation. The cups were then *separately* mounted on insulators three inches high, but this was not found to be an improvement of any consequence; and the holes are now made in a small, but thick, plate of vulcanite.

In this note the numbers presented must be looked upon only as first approximations; but the apparatus has now been carefully constructed by an instrument maker, and Mr Dewar has begun an elaborate series of experiments with it, from which valuable results may soon be expected. In the trials which have as yet been made we employed a temporary apparatus, rudely built up of wires, sealing-wax, and gutta-percha. We have rather been endeavouring to determine whether the process, complicated as it is by the inertia of the movable part of the electrometer, the quickness with which the rocking can be conducted, and the rate at which the polarization begins to diminish as soon as the polarized plates are detached from the decomposing battery, is capable of being made to give good results, than in actually attempting to get such. So far as I can yet see, the first of these complications is alone likely to cause any serious embarrassment; and should such be the case, which I do not anticipate, a form of experiment a little more laborious than that above described, and which I have already once or twice tried, seems to be well adapted to meet it.

The following are, for the most part, means of a great number of determinations. The electrolyte was usually dilute commercial sulphuric acid, 1 part acid to 10 of water; and to the lead and other impurities it was found to contain, we may ascribe the fact that the results were not very accordant from day to day, so that it was not easy to decide how to take the means. Mr Dewar is now working with substances chemically pure, and obtains much more constant results.

The unit employed is the electromotive force of an ordinary Daniell's cell. The

Grove's cells used in the electrolysis had (very constantly) an electromotive force about 1.74 times as great.

I. FRESHLY BURNED PLATINUM PLATES.

No. of Grove's cells in decomposing battery . . . . .	1	2	3	4	8
Resulting polarization . . . . .	1.64	1.98	2.01	2.12	2.30

II. PLATINUM +, PALLADIUM -.

Cells . . . . .	1	2	4
Polarization . . . . .	1.50	1.82	1.85

III. PALLADIUM +, PLATINUM -.

Cells . . . . .	1	2	4
Polarization . . . . .	1.60	1.92	1.91 (?)

IV. WITH THREE CELLS.

Polarization . . . . .	Platinum +, Iron - .	Platinum -, Iron + .	Iron Plates.
	2.16	0.0	0.0

V. ALUMINIUM PLATES.

Cells . . . . .	1	2	3	4	6
Polarization . . . . .	1.09	2.17	2.44 (?)	4.01	5.20

The last results are very remarkable, showing, as they do, from aluminium electrodes a reverse electromotive force of more than five Daniell's when six Grove's are in circuit. The polarization alters so rapidly during the electrolysis (in the case of aluminium) that I cannot be certain that the numbers above given represent fully the maximum effect. Various other combinations have been tried, but are being repeated by Mr Dewar.

## XVII.

ON THE STEADY MOTION OF AN INCOMPRESSIBLE FLUID  
IN TWO DIMENSIONS.

[*Proceedings of the Royal Society of Edinburgh, March 21, 1870.*]

WHILE discussing some of Mr Smith's\* applications of Maxwell's ingenious idea of representing galvanic currents by the motions of an imaginary fluid, I was led to the present investigation. I have since found that, as was only to be expected, I had been anticipated in a great many of the results I obtained:—especially by Stokes, in the *Trans. of the Cambridge Phil. Soc.* 1843. Still it appears to me that I have a few novel results to communicate.

If  $\psi = \text{const.}$  be the equation of a current-line, Stokes has shown that

$$\frac{d^2\psi}{dx^2} + \frac{d^2\psi}{dy^2} = f(\psi),$$

where  $f$  is an arbitrary function.

By the integration of this equation various singular results are obtained, especially as to the nature of the families of curves which can be lines of flow.

The equation of lines of equal pressure is then formed, and from it corresponding results are derived. A curious result is obtained when the motion is irrotational; in which case there is a velocity-potential  $\phi$ , and we have

\* [The reference is to *Proc. R.S.E.* VII. p. 79, where there is a remarkable paper, "*On the Flow of Electricity in Conducting Surfaces,*" which seems not to have received the attention it deserves. The Author, the late Prof. Robertson Smith, was for a short time Official Assistant to the Professor of Natural Philosophy in Edinburgh University, and of course directed his attention mainly to physical subjects. 1897.]

$$P = C - \frac{2\rho}{\rho} = \left(\frac{d\phi}{dx}\right)^2 + \left(\frac{d\phi}{dy}\right)^2,$$

$$\frac{d^2\phi}{dx^2} + \frac{d^2\phi}{dy^2} = 0.$$

Here the elimination of  $\phi$  gives us

$$\frac{d^2 \log P}{dx^2} + \frac{d^2 \log P}{dy^2} = 0.$$

The method is also applied to certain cases of motion which, though not steady, can be treated as if they were steady—viz., cases in which a given state of motion is propagated in the fluid by translation or rotation; so that to a spectator moving in a given manner in a plane parallel to the fluid, the motion *appears* to be steady. Thus, for instance, we can treat as steady motion the case of two equal parallel vortex-filaments rotating either in the same or in contrary directions.

[It is easy to see that, because

$$\frac{d^2\phi}{dx^2} + \frac{d^2\phi}{dy^2} = 0,$$

we have  $\frac{d}{dx} \log \left\{ \left(\frac{d\phi}{dx}\right)^2 + \left(\frac{d\phi}{dy}\right)^2 \right\} = -2 \frac{d}{dy} \tan^{-1} \frac{d\phi}{dy} \Big/ \frac{d\phi}{dx},$

and  $\frac{d}{dy} \log \left\{ \left(\frac{d\phi}{dx}\right)^2 + \left(\frac{d\phi}{dy}\right)^2 \right\} = 2 \frac{d}{dx} \tan^{-1} \frac{d\phi}{dy} \Big/ \frac{d\phi}{dx};$

whence the theorem above.

But the reason for it appears, even more clearly, thus:—

$$\phi = f(x + iy) + F(x - iy),$$

so that  $P = \left(\frac{d\phi}{dx}\right)^2 + \left(\frac{d\phi}{dy}\right)^2 = (f' + F')^2 - (f' - F')^2 = 4f'F';$

and  $\log P$  is therefore of the same form as  $\phi$ . 1897.]

## XVIII.

## ON THE MOST GENERAL MOTION OF AN INCOMPRESSIBLE FLUID.

[*Proceedings of the Royal Society of Edinburgh, March 21, 1870.*]

THIS is a quaternion investigation into the circumstances of fluid motion, especially with reference to the case of vortices. The method employed is very similar to that which I gave to the Society in 1862 (No. VI. above).

It is shown that if  $\sigma$  be the vector-velocity of a particle of fluid, so that

$$\sigma = iu + jv + kw,$$

and if we introduce the operators  $D_\sigma$  and  $\delta_\sigma$  such that

$$D_\sigma = \frac{d}{dt} + u \frac{d}{dx} + v \frac{d}{dy} + w \frac{d}{dz} = \frac{d}{dt} + \delta_\sigma,$$

together with Hamilton's operator

$$\nabla = i \frac{d}{dx} + j \frac{d}{dy} + k \frac{d}{dz},$$

the equations of fluid motion and of continuity are

$$\left. \begin{aligned} \nabla P - \frac{1}{r} \nabla p &= D_\sigma \sigma \\ \delta \nabla \sigma &= 0, \end{aligned} \right\}$$

where  $r$  is the density, and  $P$  the potential of the applied forces.



The principal transformation is effected by means of the curious theorem in kinematics

$$V(\nabla D_\sigma \sigma - D_\sigma \nabla \sigma) = -\delta_{\nabla \sigma} \sigma - V \nabla \sigma S \nabla \sigma \dots\dots\dots(A).$$

Thus, for instance, we have from the equation of motion

$$V \nabla D_\sigma \sigma = 0,$$

because  $\nabla^2 \left( P - \frac{p}{r} \right)$  is obviously a scalar. The above theorem then gives

$$D_\sigma \nabla \sigma = \delta_{\nabla \sigma} \sigma,$$

which proves that if  $\nabla \sigma$  is ever zero for any particle of the fluid it must remain so for that particle.

As an additional instance of the simplicity of the method employed, the following may be given in this abstract:—

If  $\tau$  be the instantaneous axis of the element of fluid, whose velocity is  $\sigma$ , we have

$$\nabla \sigma = -2\tau.$$

But  $S \nabla^2 \sigma = 0,$

whence  $-\frac{1}{2} \nabla^2 \sigma = V \nabla \tau,$

and  $-\frac{1}{2} \sigma = \nabla^{-2} 0 + \nabla^{-2} V \nabla \tau.$

This contains the solution of the problem, treated by Helmholtz, to determine the linear velocity of each fluid particle, when the angular velocity is given.

[In the original the last term on the right of equation A, above, was unfortunately omitted. Though there were obvious printer's errors also, the omission was probably due to a premature introduction of the *physical* condition

$$S \nabla \sigma = 0.$$

The absence of the term did not, of course, affect the physical results which follow. A later Note, of date June 4th, 1888, will supply some detail about the transformation above. 1897.]

## XIX.

## ON GREEN'S AND OTHER ALLIED THEOREMS.

[*Transactions of the Royal Society of Edinburgh*, Vol. xxvi. Received April 29th,  
Read May 16th, 1870.]

I WAS originally attracted to the study of Quaternions by Sir W. R. Hamilton's ingeniously devised and most valuable operator

$$\nabla = i \frac{d}{dx} + j \frac{d}{dy} + k \frac{d}{dz},$$

to which he called special attention (*Lectures on Quaternions*, § 620) on account of its promise of usefulness in physical applications. But I soon found that in order that its full power may be applied, in general investigations, it is necessary that we should have processes of definite integration, of the kinds required in physics, applicable to quaternion symbols and not merely to scalar variables. I often consulted Hamilton about this want, and he promised to endeavour to supply it at some future time. I fancy that shortly before his death he must in some way have supplied it, though he certainly did not print, nor does he appear even to have written, anything on the subject. In one of the last letters I received from him, he said that he intended to conclude the final chapter of his *Elements*, which is devoted to physical applications, by some sections on the use of the operator mentioned above. That chapter remains unfinished, and as Hamilton rarely wrote down the steps of even a complex train of mathematical reasoning until he had mentally completed it, it is to be feared that this portion of his investigations is entirely lost. So far as the analytical aspect of Quaternions is concerned, this loss is very serious indeed, for there can be little doubt that Hamilton's solution would have been of immense value from the purely mathematical point of view. [From a letter of Hamilton's, quoted in his *Life* (III. 194), it appears that in this idea I was altogether mistaken. 1889.]

I have recently succeeded to a certain extent, by a simple, though not very direct, process, in supplying the want—so far at least as to enable me to use quaternions in inquiries connected with potentials—and have thus arrived at very simple proofs of Green's celebrated theorem and various allied results, some of which appear to be new and valuable. The quaternion calculus can, in consequence, be applied without loss of its enormous special advantages to various general theories, such as Attractions, Spherical Harmonics, Fluid Motion, &c., &c. Curiously enough, I find that I had almost arrived at one of the general theorems given in the present paper so long ago as 1860 ("Quaternion Investigations connected with Electrodynamics and Magnetism," No. III. above, §§ 7, 13. Also last sentence of No. IV. above), but though I then gave a special case I did not see that a very slight modification of my work would have enabled me to generalise it. I was then seeking to derive from my formulæ the well-known physical result, and not thinking of extending the calculus itself.

Even the little advance that I have made in the present paper has enabled me to see, with a thoroughness of comprehension which I had despaired of attaining (at least by Cartesian processes), the mutual relationship of the many singular properties of the great class of analytical and physical magnitudes which satisfy what is usually known as Laplace's equation. This is, of course, due solely to the simplicity and expressiveness of quaternions in general.

1. In what follows we have constantly to deal with integrals extended over a closed surface, compared with others taken through the space enclosed by such a surface; or with integrals over a limited surface, compared with others taken round its bounding curve. The notation employed is as follows. If  $Q$  per unit of length, of surface, or of volume, at the point  $x y z$ ,  $Q$  being any quaternion, be the quantity to be summed, these sums will be denoted by

$$\iint Q ds \text{ and } \iiint Q ds,$$

when comparing integrals over a closed surface with others through the enclosed space; and by

$$\iint Q ds \text{ and } \int Q T d\rho,$$

when comparing integrals over an unclosed surface with others round its boundary. No ambiguity is likely to arise from the double use of

$$\iint Q ds,$$

for its meaning in any case will be obvious from the integral with which it is compared.

2. I have already shown (No. VI. above) that, if  $\sigma$  be the vector displacement of a point originally situated at

$$\rho = ix + jy + kz,$$

then

$$S \cdot \nabla \sigma$$

expresses the increase of density of aggregation of the points of the system caused by the displacement. (See *Appendix* to this paper.)

3. Suppose, now, space to be uniformly filled with points, and a closed surface  $\Sigma$  to be drawn, through which the points can freely move when displaced.

Then it is clear that the increase of number of points within the space  $\Sigma$ , caused by a displacement, may be obtained by either of two processes—by taking account of the increase of density at all points within  $\Sigma$ , or by estimating the excess of those which pass inwards through the surface over those which pass outwards. These are the principles usually employed (for a mere element of volume) in forming the so-called “Equation of Continuity.”

Let  $\nu$  be the normal to  $\Sigma$  at the point  $\rho$ , drawn outwards, then we have at once (by equating the two different expressions of the same quantity above explained) the equation

$$\iiint S . \nabla \sigma ds = \iiint S . \sigma U \nu ds,$$

which is our fundamental equation so long as we deal with triple integrals.

4. As a first and very simple example of its use, suppose  $\sigma$  to represent the vector force exerted upon a unit particle at  $\rho$  (of ordinary matter, electricity, or magnetism) by any distribution of attracting matter, electricity, or magnetism partly outside, partly inside  $\Sigma$ . Then, if  $P$  be the potential at  $\rho$ ,

$$\sigma = \nabla P,$$

and if  $r$  be the density of the attracting matter, &c., at  $\rho$ ,

$$\nabla \sigma = \nabla^2 P = 4\pi r,$$

by Poisson's extension of Laplace's equation.

Substituting in the fundamental equation, we have

$$4\pi \iiint r ds = 4\pi M = \iiint S . \nabla P U \nu ds,$$

where  $M$  denotes the whole quantity of matter, &c., inside  $\Sigma$ . This is a well-known theorem.

5. Let  $P$  and  $P_1$  be any scalar functions of  $\rho$ , we can of course find the distribution of matter, &c., requisite to make either of them the potential at  $\rho$ ; for, if the necessary densities be  $r$  and  $r_1$  respectively, we have as before

$$\nabla^2 P = 4\pi r, \quad \nabla^2 P_1 = 4\pi r_1.$$

Now

$$\nabla . PP_1 = P \nabla P_1 + P_1 \nabla P,$$

and

$$\nabla^2 . PP_1 = P \nabla^2 P_1 + P_1 \nabla^2 P + 2S . \nabla P \nabla P_1.$$

But, by the fundamental theorem,

$$\iiint \nabla^2 . PP_1 ds = \iiint S . (\nabla . PP_1) U \nu ds = \iiint S . (P \nabla P_1 + P_1 \nabla P) U \nu ds.$$

Substituting the above value of  $\nabla^2 . PP_1$ , this becomes

$$\iiint S . (P \nabla P_1 + P_1 \nabla P) U \nu ds = \iiint (P \nabla^2 P_1 + P_1 \nabla^2 P) ds + 2 \iiint S . \nabla P \nabla P_1 ds.$$

But, obviously, we have also by the fundamental theorem

$$\iiint S.(P\nabla P_1 - P_1\nabla P) U_\nu ds = \iiint (P\nabla^2 P_1 - P_1\nabla^2 P) ds,$$

and the two latter equations give

$$\begin{aligned} \iiint S.\nabla P\nabla P_1 ds &= -\iiint P_1\nabla^2 P ds + \iint P_1 S.\nabla P U_\nu ds, \\ &= -\iiint P\nabla^2 P_1 ds + \iint P S.\nabla P_1 U_\nu ds, \end{aligned}$$

which are the common forms of Green's Theorem. Sir W. Thomson's extension of it follows at once from the same proof.

6. If  $P_1$  be a many-valued function, but  $\nabla P_1$  single-valued, and if  $\Sigma$  be a multiply-connected\* space, the above expressions require a modification which was first shown to be necessary by Helmholtz, and first supplied by Thomson. For simplicity, suppose  $\Sigma$  to be doubly-connected (as a ring or endless rod, whether knotted or not). Then if it be cut through by a surface  $s$ , it will become simply-connected, but the surface-integrals have to be increased by terms depending upon the portions thus added to the whole surface. In the first form of Green's Theorem, just given, the only term altered is the last: and it is obvious that if  $p_1$  be the increase of  $P_1$  after a complete circuit of the ring, the portion to be added to the right-hand side of the equation is

$$p_1 \iint S.\nabla P U_\nu ds$$

taken over the cutting surface only. Similar modifications are easily seen to be produced by each additional complexity in the space  $\Sigma$ .

7. The immediate consequences of Green's Theorem are well known, so that I take only one instance.

Let  $P$  and  $P_1$  be the potentials of one and the same distribution of matter, and let none of it be within  $\Sigma$ . Then we have

$$\iiint (\nabla P)^2 ds = \iint P S.\nabla P U_\nu ds,$$

so that if  $\nabla P$  is zero all over the surface of  $\Sigma$ , it is zero all through the interior; *i.e.*, the potential is constant inside  $\Sigma$ . If  $P$  be the velocity-potential in the irrotational motion of an incompressible fluid, this equation shows that there can be no such motion of the fluid unless there is a normal motion at some part of the bounding surface, so long at least as  $\Sigma$  is simply-connected.

Again, if  $\Sigma$  is an equipotential surface,

$$\iiint (\nabla P)^2 ds = P \iint S.\nabla P U_\nu ds = P \iiint \nabla^2 P ds$$

by the fundamental theorem. But there is by hypothesis no matter inside  $\Sigma$ , so this shows that the potential is constant throughout the interior. Thus there can be no

\* Called by Helmholtz, after Riemann, *mehrfach zusammenhängend*. In translating Helmholtz's paper (*Phil. Mag.* 1867) I used the above as an English equivalent. Sir W. Thomson in his great paper on *Vortex Motion* (*Trans. R.S.E.* 1868) uses the expression "multiply-continuous."

equipotential surface, not including some of the attracting matter, within which the potential can change. Thus it cannot have a maximum or minimum value at points unoccupied by matter.

8. If, in the fundamental theorem, we suppose

$$\sigma = \nabla\tau,$$

which imposes the condition that  $S \cdot \nabla\sigma = 0$ ,

*i.e.*, that the  $\sigma$  displacement is effected without condensation, it becomes

$$\iint S \cdot \nabla\tau U\nu ds = \iint S \cdot \nabla^2\tau d\zeta = 0.$$

Suppose any closed curve to be traced on the surface  $\Sigma$ , dividing it into two parts. This equation shows that the surface-integral is the same for both parts, the difference of sign being due to the fact that the normal is drawn in opposite directions on the two parts. Hence we see that, with the above limitation of the value of  $\sigma$ , the double integral is the same for all surfaces bounded by a given closed curve. It must therefore be expressible by a single integral taken round the curve. The value of this integral will presently be determined.

9. The theorem of § 4 may be written

$$\iint \nabla^2 P d\zeta = \iint S \cdot U\nu \nabla P ds = \iint S (U\nu \nabla) P ds.$$

From this we conclude at once that if

$$\sigma = iP + jP_1 + kP_2,$$

(which may, of course, represent any vector whatever) we have

$$\iint \nabla^2 \sigma d\zeta = \iint S (U\nu \nabla) \sigma ds,$$

or, if

$$\nabla^2 \sigma = \tau,$$

$$\iint \tau d\zeta = \iint S (U\nu \nabla^{-1}) \tau ds.$$

This gives us the means of representing, by a surface-integral, a vector-integral taken through a definite space. We have already seen how to do the same for a scalar-integral—so that we can now express in this way, subject, however, to an ambiguity presently to be mentioned, the general integral

$$\iint q d\zeta,$$

where  $q$  is any quaternion whatever. It is evident that it is only in certain classes of cases that we can *expect* a perfectly definite expression of such a volume-integral in terms of a surface-integral.

10. In the above formula for a vector-integral there may present itself an ambiguity introduced by the inverse operation

$$\nabla^{-1}$$

to which we must devote a few words. The assumption

$$\nabla^2 \sigma = \tau$$

is tantamount to saying that, as the constituents of  $\sigma$  are the potentials of certain distributions of matter, &c., those of  $\tau$  are the corresponding densities each multiplied by  $4\pi$ .

If, therefore,  $\tau$  be given throughout the space enclosed by  $\Sigma$ ,  $\sigma$  is given by this equation *so far only* as it depends upon the distribution within  $\Sigma$ , and must be completed by an arbitrary vector depending on *three* potentials of mutually independent distributions exterior to  $\Sigma$ .

But, if  $\sigma$  be given,  $\tau$  is perfectly definite; and as

$$\nabla\sigma = \nabla^{-1}\tau,$$

the value of  $\nabla^{-1}$  is also completely defined. These remarks must be carefully attended to in using the theorem above: since they involve as particular cases of their application many curious theorems in Fluid Motion, &c. To these, however, I shall not further allude here, as I propose to make them the subject of a separate communication to the Society. [Sec, however, *Appendix* to this paper, § 25. 1897.]

11. We now come to relations between the results of integration extended over a non-closed surface and round its boundary.

Let  $\sigma$  be any vector function of the position of a point. The line-integral whose value we seek as a fundamental theorem is

$$\int S \cdot \sigma d\tau,$$

where  $\tau$  is the vector of any point in a small closed curve, drawn from a point within it, and in its plane.

Let  $\sigma_0$  be the value of  $\sigma$  at the origin of  $\tau$ , then

$$\sigma = \sigma_0 - S(\tau\nabla)\sigma_0$$

(No. VI. above; see also *Appendix* to this paper), so that

$$\int S \cdot \sigma d\tau = \int S \cdot \{\sigma_0 - S(\tau\nabla)\sigma_0\} d\tau.$$

But

$$\int d\tau = 0,$$

because the curve is closed; and (Tait on *Electro-Dynamics*, &c. No. III. above, § 13), we have generally

$$\int S \cdot \tau \nabla S \cdot \sigma_0 d\tau = \frac{1}{2} S \cdot \nabla (\tau S \sigma_0 \tau - \sigma_0 \int V \cdot \tau d\tau).$$

Here the integrated part vanishes for a closed circuit, and

$$\frac{1}{2} \int V \cdot \tau d\tau = ds U\nu,$$

where  $ds$  is the area of the small closed curve, and  $U\nu$  is a unit-vector perpendicular to its plane. Hence

$$\int S \cdot \sigma_0 d\tau = S \cdot \nabla \sigma_0 U\nu \cdot ds.$$

Now, any finite portion of a surface may be broken up into small elements such as

we have just treated, and the sign only of the integral along each portion of a bounding curve is changed when we go round it in the opposite direction. Hence, just as Ampère did with electric currents, substituting for a finite closed circuit a network of an infinite number of infinitely small ones, in each contiguous pair of which the common boundary is described by equal currents in opposite directions, we have for a finite unclosed surface

$$\int S \cdot \sigma d\rho = \iint S \cdot \nabla \sigma U \nu \cdot ds.$$

There is no difficulty in extending this result to cases in which the bounding curve consists of detached ovals, or possesses multiple points. This theorem seems to have been first given by Stokes (Smith's Prize Examination, 1854. See also Thomson and Tait's *Nat. Phil.* § 190 (j); and Thomson on *Vortex Motion*, *Trans. R.S.E.*, 1868-9, § 60 (q)), where it has the form

$$\int (\alpha dx + \beta dy + \gamma dz) = \iint ds \left\{ l \left( \frac{d\gamma}{dy} - \frac{d\beta}{dz} \right) + m \left( \frac{d\alpha}{dz} - \frac{d\gamma}{dx} \right) + n \left( \frac{d\beta}{dx} - \frac{d\alpha}{dy} \right) \right\}.$$

It solves the problem suggested by the result of § 8 above.

12. If  $\sigma$  represent the vector force acting on a particle of matter at  $\rho$ ,  $-S \cdot \sigma d\rho$  represents the work done while the particle is displaced along  $d\rho$ , so that the single integral

$$\int S \cdot \sigma d\rho$$

of last section, taken with a negative sign, represents the work done during a complete cycle. When this integral vanishes it is evident that, if the path be divided into any two parts, the work spent during the particle's motion through one part is equal to that gained in the other. Hence the system of forces must be conservative, *i.e.*, must do the same amount of work for all paths having the same extremities.

But the equivalent double integral must also vanish. Hence a conservative system is such that

$$\iint ds S \cdot \nabla \sigma U \nu = 0,$$

whatever be the form of the finite portion of surface of which  $ds$  is an element. Hence, as  $\nabla \sigma$  has a fixed value at each point of space, while  $U \nu$  may be altered at will, we must have

$$V \nabla \sigma = 0,$$

or

$$\nabla \sigma = \text{scalar}.$$

If we call  $X$ ,  $Y$ ,  $Z$  the component forces parallel to rectangular axes, this extremely simple equation is equivalent to the well-known conditions

$$\frac{dX}{dy} - \frac{dY}{dx} = 0, \quad \frac{dY}{dz} - \frac{dZ}{dy} = 0, \quad \frac{dZ}{dx} - \frac{dX}{dz} = 0.$$

Returning to the quaternion form, as far less complex, we see that

$$\nabla \sigma = \text{scalar} = 4\pi r, \text{ suppose,}$$

implies that

$$\sigma = \nabla P,$$



where  $P$  is a scalar such that  $\nabla^2 P = 4\pi r$ ;

that is,  $P$  is the potential of a distribution of matter, magnetism, or statical electricity, of volume-density  $r$ .

Hence, for a non-closed path, under conservative forces

$$\begin{aligned} -\int S \cdot \sigma d\rho &= -\int S \cdot \nabla P d\rho \\ &= -\int S (d\rho \nabla) P \\ &= \int d_{d\rho} P = \int dP \text{ (see Appendix)} \\ &= P_1 - P_0, \end{aligned}$$

depending solely on the values of  $P$  at the extremities of the path.

13. A Vector theorem, which is of great use, and which corresponds to the Scalar theorem of § 11, may easily be obtained. Thus, with the notation already employed,

$$\begin{aligned} \int V \cdot \sigma d\tau &= \int V \{ \sigma_0 - S(\tau \nabla) \sigma_0 \} d\tau, \\ &= -\int S(\tau \nabla) V \cdot \sigma_0 d\tau. \end{aligned}$$

Now  $V \cdot V(V\tau d\tau \cdot \nabla) \sigma_0 = S(\tau \nabla) V \cdot \sigma_0 d\tau + S(d\tau \nabla) V\tau \sigma_0$ ,

and  $d\{S(\tau \nabla) V\sigma_0\} = S(\tau \nabla) V \cdot \sigma_0 d\tau + S(d\tau \nabla) V\sigma_0\tau$ .

Adding, and omitting the term which is the same at both limits, we have

$$\int V \cdot \sigma d\tau = -V \cdot (V \cdot U\nabla) \sigma_0 ds.$$

Extended as above to any closed curve, this takes at once the form

$$\int V \cdot \sigma d\rho = -\iint ds V \cdot (V \cdot U\nabla) \sigma.$$

Of course, in many cases of the attempted representation of a quaternion surface-integral by another taken round its bounding curve, we are met by ambiguities as in the case of the space-integral (§ 9): but their origin, both analytically and physically, is in general obvious.

14. If  $P$  be any scalar function of  $\rho$ , we have (by the process of § 11, above)

$$\begin{aligned} \int P d\tau &= \int \{ P_0 - S(\tau \nabla) P_0 \} d\tau \\ &= -\int S \cdot \tau \nabla P_0 \cdot d\tau. \end{aligned}$$

But  $-V(V\tau d\tau \cdot \nabla) = d\tau S \cdot \tau \nabla - \tau S \cdot d\tau \nabla$ ,

and  $d(\tau S \tau \nabla) = d\tau S \cdot \tau \nabla + \tau S \cdot d\tau \nabla$ .

These give  $\int P d\tau = -\frac{1}{2}(\tau S \tau \nabla + \int V(V\tau d\tau \cdot \nabla)) P_0 = ds V \cdot U\nabla P_0$ .

Hence, for a closed curve of any form, we have

$$\int P d\rho = \iint ds V \cdot U\nabla P,$$

from which the theorems of §§ 11, 13 may easily be deduced.

15. The above are but a few of the simpler of an immense host of theorems which any one with some knowledge of quaternions may easily work out for himself, by developing a little farther, or applying to other combinations, the processes just explained. I shall, therefore, give no more of them until I have an opportunity of, at the same time, showing their ready applicability and great value in physical investigations.

*Appendix, added June 3rd, 1870.*

16. At the instance of Prof. Kelland, to whom this paper was referred, I append a slight sketch of some of the properties of the operator  $\nabla$ , of which so much use has been made in the foregoing paragraphs. Most of the results now to be given have been already published by myself, but the mode in which they were formerly deduced has been abandoned for one more purely quaternionic.

17. It may perhaps be useful to commence with a different form of definition of the operator  $\nabla$ , as we shall thus, if we desire it, entirely avoid the use of ordinary Cartesian co-ordinates. For this purpose we write

$$S. \alpha \nabla = -d_{\alpha},$$

where  $\alpha$  is any unit-vector, the meaning of the right-hand operator (neglecting its sign) being the *rate of change of the function to which it is applied per unit of length in the direction of the unit-vector  $\alpha$* . If  $\alpha$  be not a unit-vector we may treat it as a vector-velocity, and then the right-hand operator means the *rate of change per unit of time due to the change of position*.

Let  $\alpha, \beta, \gamma$  be any rectangular system of unit-vectors, then by a fundamental quaternion transformation

$$\nabla = -\alpha S\alpha \nabla - \beta S\beta \nabla - \gamma S\gamma \nabla = \alpha d_{\alpha} + \beta d_{\beta} + \gamma d_{\gamma}$$

which is identical with Hamilton's form given above. (*Lectures*, § 620.)

18. This mode of viewing the subject enables us to see at once that the effect of applying  $\nabla$  to any scalar function of the position of a point is to give its *vector of most rapid increase*. Hence, when it is applied to a potential  $u$ , we have

$$\nabla u = \text{vector-force at } \rho.$$

If  $u$  be a velocity-potential, we obtain the velocity of the fluid element at  $\rho$ ; and if  $u$  be the temperature of a conducting solid we obtain the flux of heat. Finally, whatever series of surfaces is represented by

$$u = C,$$

the vector  $\nabla u$  is the normal at the point  $\rho$ , and its length is inversely as the normal distance at that point between two consecutive surfaces of the series.

Hence it is evident that  $S.d\rho\nabla u = -du$ ,  
or, as it may be written,  $-S.d\rho\nabla = d$ ;

the left-hand member therefore expresses total differentiation in virtue of any arbitrary, but small, displacement  $d\rho$ .

19. To interpret the operator  $V.\alpha\nabla$  let us apply it to a potential function  $u$ . Then we easily see that  $u$  may be taken under the vector sign, and the expression

$$V(\alpha\nabla)u = V.\alpha\nabla u$$

denotes the vector-couple due to the force at  $\rho$  about a point whose relative vector is  $\alpha$ .

Again, if  $\sigma$  be any vector function of  $\rho$ , we have by ordinary quaternion operations

$$V(\alpha\nabla).\sigma = S.\alpha V\nabla\sigma + \alpha S\nabla\sigma - \nabla S\alpha\sigma.$$

The meaning of the third term (in which it is of course understood that  $\nabla$  operates on  $\sigma$  alone) is obvious from what precedes. It remains that we explain the other terms.

20. These involve the very important quantities (not *operators* such as the expressions we have been hitherto considering),

$$S.\nabla\sigma \text{ and } V.\nabla\sigma,$$

which occur very frequently in the preceding paper. There we looked upon  $\sigma$  as the displacement, or as the velocity, of a point situated at  $\rho$ . Let us now consider the group of points situated near to that at  $\rho$ , as the quantities to be interpreted have reference to the deformation of the group.

21. Let  $\tau$  be the vector of one of the group relative to that situated at  $\rho$ . Then after a small interval of time  $t$ , the actual co-ordinates become

$$\rho + t\sigma$$

and  $\rho + \tau + t\{\sigma - S(\tau\nabla)\sigma\}$

by the definition of  $\nabla$  in § 17. Hence, if  $\phi$  be the linear and vector function representing the deformation of the group, we have

$$\phi\tau = \tau - tS(\tau\nabla)\sigma.$$

The farther solution is rendered very simple by the fact that we may assume  $t$  to be so small that its square and higher powers may be neglected.

If  $\phi'$  be the function conjugate to  $\phi$ , we have

$$\phi'\tau = \tau - t\nabla S\tau\sigma.$$

Hence

$$\begin{aligned} \phi\tau &= \frac{1}{2}(\phi + \phi')\tau + \frac{1}{2}(\phi - \phi')\tau \\ &= \tau - \frac{t}{2}[S(\tau\nabla)\sigma + \nabla S\tau\sigma] - \frac{t}{2}V.\tau V\nabla\sigma. \end{aligned}$$

The first three terms form a self-conjugate linear and vector function of  $\tau$ , which we may denote for a moment by  $\varpi\tau$ . Hence

$$\phi\tau = \varpi\tau - \frac{t}{2} V. \tau V\nabla\sigma,$$

or, omitting  $t^2$  as above, 
$$\phi\tau = \varpi\tau - \frac{t}{2} V. \varpi\tau V\nabla\sigma.$$

Hence the deformation may be decomposed into—1st, the pure strain  $\varpi$ , 2nd, the rotation

$$\frac{t}{2} V\nabla\sigma.$$

Thus the *vector-axis of rotation of the group* is

$$\frac{1}{2} V\nabla\sigma.$$

If we were content to avail ourselves of the ordinary results of Cartesian investigations, we might at once have reached this conclusion by noticing that

$$V\nabla\sigma = i \left( \frac{d\zeta}{dy} - \frac{d\eta}{dz} \right) + j \left( \frac{d\xi}{dz} - \frac{d\zeta}{dx} \right) + k \left( \frac{d\eta}{dx} - \frac{d\xi}{dy} \right),$$

and remembering the formulæ of Stokes and Helmholtz.

22. In the same way, as

$$S\nabla\sigma = -\frac{d\xi}{dx} - \frac{d\eta}{dy} - \frac{d\zeta}{dz},$$

we recognise the *cubical compression* of the group of points considered. It would be easy to give this a more strictly quaternionic form by employing the definition of § 17. But, working with quaternions, we ought to obtain all our results by their help alone; so that we proceed to prove the above result by finding the volume of the ellipsoid into which an originally spherical group of points has been distorted in time  $t$ .

For this purpose, we refer again to the equation of deformation

$$\phi\tau = \tau - tS(\tau\nabla)\sigma,$$

and form the cubic in  $\phi$  according to Hamilton's exquisite process. We easily obtain, remembering that  $t^2$  is to be neglected\*,

$$0 = \phi^3 - (3 - tS\nabla\sigma)\phi^2 + (3 - 2tS\nabla\sigma)\phi - (1 - tS\nabla\sigma),$$

\* Thus, in Hamilton's notation,  $\lambda, \mu, \nu$  being any three non-coplanar vectors, and  $m, m_1, m_2$  the coefficients of the cubic,

$$\begin{aligned} -mS. \lambda\mu\nu &= S. \phi'\lambda\phi'\mu\phi'\nu \\ &= S. (\lambda - t\nabla S\lambda\sigma)(\mu - t\nabla S\mu\sigma)(\nu - t\nabla S\nu\sigma) \\ &= S. (\lambda - t\nabla S\lambda\sigma)(V\mu\nu - tV\mu\nabla S\nu\sigma + tV\nu\nabla S\mu\sigma) \\ &= S. \lambda\mu\nu - t[S. \mu\nu\nabla S\lambda\sigma + S. \nu\lambda\nabla S\mu\sigma + S. \lambda\mu\nabla S\nu\sigma] \\ &= S. \lambda\mu\nu - tS. [\lambda S. \mu\nu\nabla + \mu S. \nu\lambda\nabla + \nu S. \lambda\mu\nabla]\sigma \\ &= S. \lambda\mu\nu - tS. \lambda\mu\nu S\nabla\sigma. \end{aligned}$$

or

$$0 = (\phi - 1)^2 (\phi - 1 + tS\nabla\sigma),$$

The roots of this equation are the ratios of the diameters of the ellipsoid whose directions are unchanged to that of the sphere. Hence the volume is increased by the factor

$$1 - tS\nabla\sigma,$$

from which the truth of the preceding statement is manifest.

23. As the process in last section depends essentially on the use of a non-conjugate vector function, with which the reader is less likely to be acquainted than with the more usually employed forms, I add another investigation.

Let  $\varpi = \phi\tau = \tau - tS(\tau\nabla)\sigma.$

Then  $\tau = \phi^{-1}\varpi = \varpi + tS(\varpi\nabla)\sigma.$

Hence since if, before distortion, the group formed a sphere of radius 1, we have

$$T\tau = 1,$$

the equation of the ellipsoid is  $T\{\varpi + tS(\varpi\nabla)\sigma\} = 1,$

or  $\varpi^2 + 2tS\varpi\nabla S\varpi\sigma = -1.$

This may be written  $S.\varpi\chi\varpi = S.\varpi\{\varpi + t\nabla S\varpi\sigma + tS(\varpi\nabla)\sigma\} = -1,$

where  $\chi$  is now self-conjugate.

Hamilton has shown that the reciprocal of the product of the squares of the semiaxes is

$$-S.\chi^i\chi^j\chi^k,$$

whatever rectangular system of unit-vectors is denoted by  $i, j, k.$

Substituting the value of  $\chi,$  we have

$$\begin{aligned} & -S.\{i + t\nabla Si\sigma + tS(i\nabla)\sigma\}(j + \&c.)(k + \&c.) \\ & = -S.\{i + t\nabla Si\sigma + tS(i\nabla)\sigma\}\{i + 2tiS\nabla\sigma - tS(i\nabla)\sigma - t\nabla Si\sigma\} \\ & = 1 + 2tS\nabla\sigma. \end{aligned}$$

The ratio of volumes of the ellipsoid and sphere is therefore, as before,

$$\frac{1}{\sqrt{1 + 2tS\nabla\sigma}} = 1 - tS\nabla\sigma.$$

$$\begin{aligned} m_1 S.\lambda\mu\nu &= S.\lambda\phi'\mu\phi'\nu + S.\mu\phi'\nu\phi'\lambda + S.\nu\phi'\lambda\phi'\mu \\ &= S.\lambda(V\mu\nu - tV\mu\nabla S\nu\sigma + tV\nu\nabla S\mu\sigma) + \&c. \\ &= S.\lambda\mu\nu - tS.\lambda\mu\nabla S\nu\sigma - tS.\nu\lambda\nabla S\mu\sigma + \&c. \\ &= 3S.\lambda\mu\nu - 2tS\nabla\sigma S.\lambda\mu\nu. \\ -m_2 S.\lambda\mu\nu &= S.\lambda\mu\phi'\nu + S.\mu\nu\phi'\lambda + S.\nu\lambda\phi'\mu \\ &= S.\lambda\mu\nu - tS.\lambda\mu\nabla S\nu\sigma + \&c. \\ &= 3S.\lambda\mu\nu - tS\nabla\sigma S.\lambda\mu\nu. \end{aligned}$$

24. Before concluding I may append a generalised form of Green's Theorem, which is obviously fitted to be of use in quaternion investigations. If we put

$$\tau = iP + jP' + kP'',$$

we easily see by the equations at the end of § 5 that

$$\begin{aligned} \iiint S(\nabla P_1 \cdot \nabla) \tau ds &= -\iiint P_1 \nabla^2 \tau ds + \iint P_1 S(U\nu \cdot \nabla) \tau ds, \\ &= -\iint \tau \nabla^2 P_1 ds + \iint \tau S \cdot \nabla P_1 U\nu \cdot ds. \end{aligned}$$

As a particular case, let

$$P_1 = S\alpha\rho$$

so that

$$\nabla P_1 = iS\alpha + jSj\alpha + kSk\alpha = -\alpha,$$

$$\nabla^2 P_1 = 0,$$

we have

$$\begin{aligned} \iiint S(\alpha\nabla) \tau ds &= \iiint S\alpha\rho \nabla^2 \tau ds - \iint S\alpha\rho S(U\nu\nabla) \tau ds, \\ &= \iint \tau S \cdot \alpha U\nu ds. \end{aligned}$$

Any constant may be added to the value of  $P_1$ . The additional terms thus introduced must vanish, so that the "generalized form" above gives, as in § 9,

$$\iiint \nabla^2 \tau ds = \iint S(U\nu\nabla) \tau ds.$$

As another verification, suppose  $\tau$  constant, and we have

$$\iint S \cdot \alpha U\nu ds = 0,$$

which is obviously true. Interesting results are obtained by treating this by the processes of §§ 8, 11.

25. From one of the theorems above—viz.,

$$\iiint S(\alpha\nabla) \tau ds = \iint \tau S \cdot \alpha U\nu ds,$$

we have by the formula of § 17  $\iiint \nabla \tau ds = \iint U\nu \cdot \tau ds$ ,

a considerable extension of the fundamental theorem of § 3, which is, in fact, only its scalar part. It might have been obtained, however, as the reader will easily see, by a much more direct process. The vector part

$$\iiint V\nabla \tau ds = \iint V(U\nu \cdot \tau) ds,$$

as we see by the meaning of  $V\nabla \tau$  in § 21, is of great importance in physical applications, especially in connection with Electricity and with Fluid Motion. When

$$\tau = \nabla P,$$

where  $P$  is a scalar, the left-hand member vanishes, and the value of the right-hand member limited to a non-closed surface is then found as in § 14.

26. Again, let

$$P_1 = \rho^2,$$

which gives

$$\nabla P_1 = -2\rho,$$

$$\nabla^2 P_1 = 6.$$

We have

$$\begin{aligned} -2\iiint S(\rho\nabla) \tau ds &= -\iiint \rho^2 \nabla^2 \tau ds + \iint \rho^2 S(U\nu\nabla) \tau ds \\ &= -6\iiint \tau ds - 2\iint \tau S \cdot \rho U\nu ds. \end{aligned}$$

Now if the constituents of  $\tau$  be homogeneous functions of  $\rho$  of the  $n$ th degree, we have for any one of them

$$S \cdot \rho \nabla \xi = -n\xi,$$

so that under these circumstances

$$(n+3) \iiint \tau ds = - \iint \tau S \cdot \rho U \nu ds.$$

Of this a particular case is  $(n+3) \iiint \xi ds = - \iint \xi S \cdot \rho U \nu ds,$

which suggests many curious theorems.

27. As a verification of it, let the closed surface  $\Sigma$  which determines the limits of the integrations be itself

$$\xi = C,$$

which, of course, subjects the form of  $\xi$  to further limitations.

The right-hand member is obviously equal to

$$3C \times \text{vol. of } \Sigma,$$

because  $-S \cdot \rho U \nu$  is the perpendicular from the origin to the tangent plane at  $\rho$  to the element  $ds$ . The left-hand side may be broken up into a set of shells bounded by surfaces whose equations are

$$\xi = e^n C,$$

where  $e$  varies from 0 to 1. [This follows from the assumption that  $\xi$  is homogeneous.] The volume of the surface corresponding to any value of  $e$  is obviously

$$e^3 \times \text{vol. of } \Sigma.$$

Hence

$$ds = 3e^2 de \times \text{vol. of } \Sigma,$$

so that the left-hand member of the equation above becomes

$$(n+3) \int_0^1 3Ce^{n+2} de \times \text{vol. of } \Sigma = 3C \times \text{vol. of } \Sigma,$$

and the proposition is proved.

28. A very interesting case is when

$$\xi = \frac{1}{T\rho^3},$$

in which case  $n = -3$ , and our equation appears to become

$$(3-3) \iiint \frac{ds}{T\rho^3} = 0 = - \iint S \cdot \frac{U\rho}{T\rho^2} U \nu ds.$$

It is obvious, however, that there is an infinite element on the left hand, when  $T\rho = 0$ , *i.e.*, when the origin lies inside  $\Sigma$ ; and it is easy to see that the correct result is a simple case of the well-known equation of § 4. In fact, the expression on

the right denotes, as is evident, the whole spherical opening subtended at the origin by  $\Sigma$ . Its value is therefore 0 if the origin be without  $\Sigma$ , and  $4\pi$  if within— $\Sigma$  being supposed to be simply-connected.

29. As a final example let us suppose in § 26 that  $\xi$  is a Spherical Harmonic. Then, in addition to the condition of homogeneity there given, we have the condition

$$\nabla^2 \xi = 0,$$

and the general equation of the section referred to gives

$$2n \iiint \xi d\varsigma = \iint \rho^2 S. U\nu \nabla \xi ds,$$

so that, with the help of the final equation of § 26, we have for any closed surface whatever

$$\iint S. U\nu (2n\rho\xi + \overline{n+3\rho^2\nabla\xi}) ds = 0.$$

This integral, whose value is obviously the same for all surfaces bounded by a given closed curve, can be reduced to the form

$$\iint (T\rho)^{\frac{4n+6}{n+3}} S. U\nu \nabla \left( q_0 - \frac{\xi}{(T\rho)^{\frac{2n}{n+3}}} \right) ds,$$

where  $q_0$  is any quaternion which satisfies the condition

$$V\nabla q_0 = 0.$$

This is susceptible of various remarkable transformations, both as a double and as a single integral. But this digression might be indefinitely extended, and perhaps has already gone too far.

30. The essential basis of the whole of this theory is the great invention of Hamilton, by which it is made possible to represent as a vector-operator the square root of Laplace's operator

$$-\frac{d^2}{dx^2} - \frac{d^2}{dy^2} - \frac{d^2}{dz^2},$$

which has not yet been done by any but quaternion symbols, at least in a symmetrical, easily intelligible, and practically useful form.

It is rash to make any definite assertions on such matters, especially when a writer of such extraordinary fertility, knowledge, and power as Sir W. R. Hamilton is concerned, but to the best of my knowledge the greater part of the results given above is my own. Hamilton's treatment of  $\nabla$ , so far as I am aware of its having been published, will be found in *Proc. R.I.A.*, 1846 and 1854, (in the latter of which there is a very curious and interesting proof of Dupin's Theorem,) and in his *Lectures on Quaternions*, § 620. My own is to be found in *Quarterly Math. Journal*, October, 1860; *Proc. R.S.E.*, 1861-2, 1862-3; and *Elementary Treatise on Quaternions*, §§ 317, 319, 364, &c., 418, 421-8, Ex. 24 to Chap. IX. and 10 to Chap. XI.



## XX.

## NOTE ON LINEAR PARTIAL DIFFERENTIAL EQUATIONS.

[*Proceedings of the Royal Society of Edinburgh, June 6, 1870.*]

THE equation  $P \frac{du}{dx} + Q \frac{du}{dy} + R \frac{du}{dz} = 0$

may be put in the very simple form

$$S (\sigma \nabla) u = 0,$$

if we write

$$\sigma = iP + jQ + kR,$$

and

$$\nabla = i \frac{d}{dx} + j \frac{d}{dy} + k \frac{d}{dz}.$$

This gives, at once,

$$\nabla u = mV\theta\sigma,$$

where  $m$  is a scalar and  $\theta$  a vector (in whose tensor  $m$  might have been included, but it is kept separate for a special purpose). Hence

$$\begin{aligned} du &= -S (d\rho \nabla) u \\ &= -mS \cdot \theta \sigma d\rho \\ &= -S \cdot \theta d\tau, \end{aligned}$$

if we put

$$d\tau = -mV \cdot \sigma d\rho$$

so that  $m$  is an integrating factor of  $V \cdot \sigma d\rho$ . If a value of  $m$  can be found, it is obvious, from the form of the above equation, that  $\theta$  must be a function of  $\tau$  alone; and the integral is therefore

$$u = F(\tau) = \text{const.}$$

where  $F$  is an arbitrary scalar function.

Thus the differential equation of *Cylinders* is

$$S(\alpha\nabla)u = 0,$$

where  $\alpha$  is a constant vector. Here  $m = 1$ , and

$$u = F(V\alpha\rho).$$

That of *Cones* referred to the vertex is

$$S(\rho\nabla)u = 0.$$

Here the expression to be made integrable is

$$V \cdot \rho d\rho.$$

But Hamilton long ago showed that

$$\frac{dU\rho}{U\rho} = V \frac{d\rho}{\rho} = \frac{V \cdot \rho d\rho}{(T\rho)^2},$$

which indicates the value of  $m$ , and gives

$$u = F(U\rho) = \text{const.}$$

It is obvious that the above is only one of a great number of different processes which may be applied to integrate the differential equation. It is quite easy, for instance, to pass from it to the assumption of a vector integrating factor instead of the scalar  $m$ , and to derive the usual criterion of integrability. There is no difficulty in modifying the process to suit the case when the right-hand member is a multiple of  $u$ . In fact it seems to throw a very clear light upon the whole subject of the integration of partial differential equations. But I have not at present leisure to pursue the subject farther than to notice that if, instead of  $S(\sigma\nabla)$ , we employ other operators as  $S(\sigma\nabla)S(\tau\nabla)$ ,  $S \cdot \sigma\nabla\tau\nabla$ , &c. (where  $\nabla$  may or may not operate on  $u$  alone), we can pass to linear partial differential equations of the second and higher orders. Similar theorems can be obtained from vector operators, as  $V(\sigma\nabla)$ .

## XXI.

NOTE ON LINEAR DIFFERENTIAL EQUATIONS IN  
QUATERNIONS.

[*Proceedings of the Royal Society of Edinburgh, December 20, 1870.*]

THE generally non-commutative character of quaternion multiplication introduces into the solution even of linear differential equations with constant (quaternion) coefficients, difficulties of a somewhat novel character. To some of these which have presented themselves to me in many investigations, I wish to draw attention in the following note, but want of leisure prevents my attempting at present either to classify the numerous curious forms which may be met with in physical inquiries, even when these lead to mere vector equations of an order no higher than the second, or to develop the subject of the curious functional equations which are incidentally involved.

1. The integration of an equation such as

$$\dot{q} + mq = a,$$

where  $m$  is a *scalar* (usually a function of  $t$ , which is assumed throughout as the independent variable), and  $q$  an unknown quaternion, is obviously to be effected by the ordinary method, multiplication by  $e^{\int m dt}$ .

2. But if  $a$  be a *quaternion*, the integration of

$$\dot{q} + aq = a',$$

even when  $a$  is constant, requires a little care, unless we boldly treat  $a$  as  $m$  was treated in the preceding section. This, no doubt, gives the correct result, but the process requires to be defended. Assume therefore  $r$  to be a factor which makes the left-hand member integrable. Then we must have

$$\dot{r} = ra,$$

or, if  $r'$  be a proximate value of  $r$ ,

$$r' = r + r\delta t = r(1 + a\delta t).$$

Hence, dividing the finite interval  $t$  into a great number of equal parts, and taking the limit

$$\begin{aligned} r &= r_0 L_x \left(1 + \frac{at}{n}\right)^n \\ &= r_0 \epsilon^{at} \end{aligned}$$

where  $r_0$  is an arbitrary but constant quaternion.

Now we have

$$\begin{aligned} \epsilon^{at} &= \epsilon^{t(Sa + TVa \cdot UVa)} = \epsilon^{t(m+na)}, \text{ suppose} \\ &= \epsilon^{mt} \alpha^{\frac{2nt}{\pi}}. \end{aligned}$$

Hence the solution of the given equation is

$$\epsilon^{mt} \alpha^{\frac{2nt}{\pi}} q = \int \epsilon^{mt} \alpha^{\frac{2nt}{\pi}} a' dt,$$

the arbitrary quaternion constant  $r_0$  having disappeared, but a new one being introduced by the integration on the right.

When  $a$  is variable, the tensor of  $r$  is easily seen to be  $\epsilon^{\int Sa dt}$ , but its versor,  $s$ , is to be found from the equation

$$\dot{s} = sVa$$

the fundamental relation between the instantaneous axis and the versor of rotation of a rigid body (No. XV. above, § 7).

When  $r$  is a vector,  $\theta$  suppose, we have

$$\dot{\theta} = V\theta a,$$

whence, as above,

$$\theta = V\theta_0 \epsilon^{\int a dt}.$$

3. In the succeeding examples we restrict ourselves to equations for the determination of unknown *vectors*, as we thus avoid the introduction of the quartic equation which has been shown by Hamilton to be satisfied by a linear function of a *quaternion*. This would appear, for instance, in the solution of even the simple equation

$$\dot{q} + aqb = c$$

where  $a$  and  $b$  are constant quaternions; though, of course, its use may be avoided by employing a somewhat more cumbrous process.

4. Suppose we have

$$\dot{\rho} + \phi\rho = \alpha$$

where  $\phi$  is a self-conjugate linear and vector function with constant constituents. Operate by  $S \cdot \delta$ , and we have

$$S\delta\rho + S \cdot \rho\phi\delta = S\delta\alpha.$$

The left-hand side is a complete differential if

$$\dot{\delta} = \phi\delta.$$

The general integral of this equation may be written as

$$\delta = \epsilon^{t\phi} \delta_0$$

where  $\epsilon^\phi$  is another linear and vector function; but it is not necessary to discuss here the validity of such a result, deduced as it must be by a process of separation of symbols. [See Tait's *Quaternions*, § 290, 3rd ed. § 307.] For, on account of the properties of  $\phi$ , we may assume (since but three distinct and non-coplanar values of  $\delta$  are required)

$$\delta = x\eta$$

where  $\eta$  is a constant unit-vector, and  $x$  a scalar function of  $t$ . This gives

$$\frac{\dot{x}}{x} \eta = \phi\eta.$$

The values of  $\eta$  are therefore unit-vectors parallel to the axes of the surface

$$S\rho\phi\rho = 1,$$

and those of  $\frac{\dot{x}}{x}$  are the roots of the auxiliary cubic in  $\phi$ . Call them  $\eta_1, \eta_2, \eta_3$  and  $g_1, g_2, g_3$  respectively, then the values of  $\delta$  (into which no arbitrary constant need be introduced), are of the form

$$\epsilon^{gt} \eta.$$

Thus, finally,

$$\begin{aligned} \rho &= -\sum \eta S\eta\rho \\ &= -\sum \epsilon^{-gt} \eta [\int \epsilon^{gt} S\eta\alpha dt + C]. \end{aligned}$$

5. If, in the equation of (4), we suppose  $\alpha$  constant, we may easily apply a process similar to that of (2).

For

$$\rho' = \rho + \dot{\rho}\delta t = (1 - \delta t \cdot \phi) \rho + \alpha \delta t.$$

Hence, as  $\alpha$  is constant,

$$\begin{aligned} \rho &= L_\infty \left(1 - \frac{t\phi}{n}\right)^n \rho_0 + L_x \frac{\left(1 - \frac{t\phi}{n}\right)^n - 1}{\left(1 - \frac{t\phi}{n}\right) - 1} \cdot \frac{\alpha t}{n} \\ &= \epsilon^{-t\phi} \rho_0 + \phi^{-1} \alpha \end{aligned}$$

where  $\rho_0$  (which is arbitrary) has been increased by  $\phi^{-1}\alpha$ . It is easy to show that this agrees with the final result of (4), and the coincidence is so far a justification of the use of the method of separation of symbols.

The verification of the general result of (4), where  $\alpha$  is variable, can also be effected by this method, but not so readily.

6. Let us take the linear equation of the second order with constant coefficients (equivalent to three simultaneous linear equations in scalars of a very general form)

$$\dot{\rho} + \phi\dot{\rho} + \psi\rho = 0,$$

where  $\phi$  and  $\psi$  may, or may not, be self-conjugate.

If they be self-conjugate, this represents oscillation under the action of a force whose components, in each of three rectangular directions, are made up of parts proportional to (though not necessarily equimultiples of) the displacements in these directions. The resistance parallel to each of three other rectangular directions depends in a similar manner on the corresponding components of the velocity.

The operator in the left-hand member may be written

$$\left(\frac{d}{dt}\right)^2 + \phi \cdot \frac{d}{dt} + \psi = \left(\frac{d}{dt} + \chi\right)\left(\frac{d}{dt} + \theta\right),$$

suppose, where  $\chi$  and  $\theta$  are two new linear and vector functions.

Hence, comparing, we must have

$$\chi + \theta = \phi$$

$$\chi\theta = \psi,$$

or, eliminating  $\theta$ ,

$$\chi^2 + \psi = \chi\phi$$

a curious and apparently novel species of equation from which to determine the function  $\chi$ .

[We might have arrived at it, by a somewhat more perilous but shorter route, by assuming as a particular integral of the given equation the expression

$$\rho = \epsilon^{-t\chi}\rho_0.]$$

If we take their conjugates in addition to the two equations connecting  $\theta$  and  $\chi$ , we see at once that all four are satisfied by assuming these two functions to be conjugate to one another, provided  $\phi$  and  $\psi$  are self-conjugate. Hence in this special case we may write

$$\left. \begin{aligned} \chi &= \frac{1}{2}\phi + V \cdot \epsilon \\ \theta &= \frac{1}{2}\phi - V \cdot \epsilon \end{aligned} \right\}$$

It only remains that we should find  $\epsilon$ , and the rest of the solution is to be effected as in (4) or (5).

$$\text{We have} \quad \psi = \chi\theta = \frac{\phi^2}{4} + \frac{1}{2}(V \cdot \epsilon\phi - \phi V \cdot \epsilon) - V \cdot \epsilon V \cdot \epsilon.$$

When  $\phi$  is a constant scalar, *i.e.* when the resistance is in the direction of motion (which is the case generally in physical applications), the middle term vanishes, and we have

$$V \cdot \epsilon V \cdot \epsilon = \frac{\phi^2}{4} - \psi,$$

or, as it may be written,

$$V. \epsilon = \left( \frac{\phi^2}{4} - \psi \right)^{\frac{1}{2}}.$$

In fact, in this case,  $\phi$  and  $\chi$  are commutative in multiplication, so that the equation in  $\chi$  may be solved as an ordinary quadratic.

Even this very particular case involves a singular question, though not one of such difficulty as that of the general problem above. We have, in fact, to solve an equation of the form

$$\varpi^2 = \omega,$$

where  $\omega$  is a given, and  $\varpi$  a sought, linear and vector function. This leads to an equation of the sixth degree in  $\varpi$  with pairs of roots equal but of opposite signs. The coefficients of the cubic in  $\varpi$  are formed by the solution of a biquadratic equation\*.

\* Suppose the cubic in  $\varpi$  to be  $\varpi^3 + g\varpi^2 + g_1\varpi + g_2 = 0$ ,  
the given equation enables us to write it in either of the (really identical) forms

$$(\varpi + g)\varpi + g_1\varpi + g_2 = 0,$$

or

$$\varpi(\omega + g_1) + g\omega + g_2 = 0;$$

whence

$$\omega = \left( \frac{g\omega + g_2}{\omega + g_1} \right)^2,$$

or

$$\omega^3 + (2g_1 - g^2)\omega^2 + (g_1^2 - 2gg_2)\omega - g_2^2 = 0.$$

If the cubic in  $\omega$  be

$$\omega^3 + m\omega^2 + m_1\omega + m_2 = 0,$$

we have by comparison of coefficients

$$2g_1 - g^2 = m, \quad g_1^2 - 2gg_2 = m_1, \quad g_2^2 = -m_2$$

so that  $g_2$  is known and

$$g = \frac{g_1^2 - m_1}{2\sqrt{-m_2}},$$

where

$$2g_1 = m - \frac{(g_1^2 - m_1)^2}{4m_2}.$$

The values of  $g$  being found,  $\varpi$  is given by the expression above.

A similar process may easily be applied to the general equation of (6), but it may be well to exhibit the present simple case in its Cartesian form.

Let

$$\begin{aligned} Si\omega i &= p_1, & Si\omega j &= p_2, & Si\omega k &= p_3, \\ Sj\omega i &= q_1, & Sj\omega j &= q_2, & Sj\omega k &= q_3, \\ Sk\omega i &= r_1, & Sk\omega j &= r_2, & Sk\omega k &= r_3. \end{aligned}$$

Also let

$$\varpi = aSi + \beta Sj + \gamma Sk,$$

where

$$a = ix_1 + jx_2 + kx_3,$$

$$\beta = iy_1 + jy_2 + ky_3,$$

$$\gamma = iz_1 + jz_2 + kz_3,$$

then the problem reduces itself to the determination of the nine scalars  $x, y, z$ , &c., from nine equations of the second degree, of which we write only the first three:—viz.

$$x_1^2 + y_1x_2 + z_1x_3 = p_1,$$

$$x_2x_1 + y_2x_2 + z_2x_3 = p_2,$$

$$x_3x_1 + y_3x_2 + z_3x_3 = p_3.$$

In fact, if we apply the members of the general equation above to  $\epsilon$ , we have

$$V. \epsilon \phi \epsilon = 2 \left( \psi - \frac{\phi^2}{4} \right) \epsilon.$$

This leads to the two equations

$$S. \epsilon \left( \psi - \frac{\phi^2}{4} \right) \epsilon = 0,$$

$$S. \epsilon \phi \left( \psi - \frac{\phi^2}{4} \right) \epsilon = 0,$$

which, belonging to two cones of the second degree, give in general four values of  $\epsilon$ .

7. The interest of the general question before us, from the analytical point of view, lies mainly in the determination of the two unknown linear and vector functions  $\chi$  and  $\theta$  from the equations

$$\chi + \theta = \phi,$$

$$\chi \theta = \psi,$$

each of which is in general equivalent to *nine* or in certain cases *six* (not, as in ordinary quaternion equations, *four*, or as in vector equations *three*) simultaneous scalar equations. They have also a physical interest, inasmuch as they include the problem of finding two homogeneous strains, such that the vector-sum of their effects on any vector shall represent the effect of one given strain on that vector, while the effect of their *successive* performance in a given order on any vector shall be equivalent to that of another given strain. It is curious to compare this with the physical meaning of the differential equation from which these forms are derived.

If  $g$  be one of the roots of the symbolical cubic in  $\chi$  (of which two will in this case generally be imaginary) and  $\eta$  the corresponding unit vector, such that we have three conditions of the type

$$(\chi - g) \eta = 0,$$

we have

$$(g^2 - g\phi + \psi) \eta = 0.$$

The vectors, which satisfy this and the two similar equations, are (all three) sides (real or imaginary) of the cone of the third order

$$S. \rho \phi \rho \psi \rho = 0.$$

One curious result, which is easily derived from the equations above, is that, if a solid experience a pure strain, the planes in which any three, originally rectangular, vectors are displaced intersect in one line.



## XXII.

## ON SOME QUATERNION INTEGRALS.

## PART I.

[*Proceedings of the Royal Society of Edinburgh, December 20, 1870.*]

IN my paper on "Green's and other allied theorems" (XIX. above), I showed that

$$\int P d\rho = \iint ds V \cdot U \nu \nabla P,$$

where  $P$  is any scalar function of  $\rho$ , and the single integral is extended round any closed curve, while the double integral extends over any surface bounded by the curve,  $\nu$  being its normal vector.

Writing

$$\sigma = iP + jQ + kR$$

this gives at once 
$$\int \sigma d\rho = \iint ds (S \cdot U \nu \nabla \sigma - V \cdot (V U \nu \nabla) \sigma),$$

of which the scalar and vector parts respectively were, in the paper referred to, shown to be equal.

From these equations many very singular results may be derived, some of which form the first part of the subject of the present communication.

Let  $\sigma$  be a vector which, having continuously varying values over the surface in question, becomes  $U d\rho$  at its edge. Then

$$-\int T d\rho = \iint ds S \cdot U \nu \nabla \sigma,$$

there being no vector part on the left-hand side. This gives the *length* of any closed curve in terms of an integral taken over any surface bounded by it.

We have evidently  $T\rho dT\rho = -S\rho d\rho,$

whence  $\int PdT\rho = -\int PS \cdot U\rho d\rho = -\iint ds S \cdot U\nu \nabla (PU\rho).$

Hence  $\int \sigma dT\rho = -\iint ds S \cdot (U\rho U\nu \nabla) \sigma,$

for  $\nabla U\rho = -\frac{2}{T\rho}.$

Now if  $T\rho$  be constant over the boundary, *i.e.* if the bounding curve lie on a sphere whose centre is the origin, we have for any surface bounded by it

$$\iint ds S \cdot (U\rho U\nu \nabla) \sigma = 0,$$

*whatever* be the value of the vector  $\sigma.$

Again, if  $\sigma$  be a function of  $T\rho$  only, we have

$$\int \sigma dT\rho = 0$$

for all closed curves. Hence, whatever be the vector-function  $\phi,$  and whatever the surface and its bounding curve, we have always

$$\iint ds S \cdot (U\rho U\nu \nabla) \phi (T\rho) = 0.$$

\* \* \*

But, generally, we have also from the chief formulæ of this paper,

$$\iint S \cdot U\nu \nabla^2 \sigma ds - \iint S \cdot U\nu \nabla S \cdot \nabla \sigma ds = \int S \cdot \nabla \sigma d\rho,$$

and

$$\iint U\nu \nabla^2 P ds - \iint S \cdot U\nu \nabla \cdot \nabla P ds = \int V (d\rho \nabla) P;$$

giving finally

$$\iint V \cdot U\nu \nabla^2 \sigma ds - \iint S \cdot U\nu \nabla \cdot V \nabla \sigma ds = \int V \cdot V (d\rho \nabla) \sigma.$$

These results appear to be of considerable importance for physical applications; and are particularly interesting, because they involve the operator (indicated merely in my former paper)

$$V (d\rho \nabla).$$

The paper contains several applications and modifications of these theorems.

[The concluding portion of the above Abstract contained some strange inadvertences, arising from an attempt to extend the application of the formulæ in an unwarrantable direction. (The proper method had already been given in Nos. III. and IV. above.) Attention was called to this matter in the Abstract of Part II. which follows; and I have therefore modified the later part of the Abstract above, to a considerable extent from data there supplied for the purpose, and not otherwise reprinted. 1897.]

PART II. [Read June 3, 1872.]

Commencing afresh with the fundamental integral

$$\iiint S . \nabla \sigma ds = \iint S . U \nu \sigma ds,$$

put

$$\sigma = u \beta$$

and we have

$$\iiint (S . \beta \nabla) u ds = \iint u S . \beta U \nu ds ;$$

from which at once

$$\iiint \nabla u ds = \iint U \nu ds \dots\dots\dots(a),$$

or

$$\iiint \nabla \tau ds = \iint U \nu . \tau ds \dots\dots\dots(b).$$

Putting  $u, \tau$  for  $\tau$ , and taking the scalar, we have

$$\iiint (S (\tau \nabla) . u_1 + u_1 S . \nabla \tau) ds = \iint u_1 S . U \nu \tau ds$$

whence

$$\iiint (S (\tau \nabla) \sigma + \sigma S . \nabla \tau) ds = \iint \sigma S . U \nu \tau ds \dots\dots\dots(c).$$

As one example of the important results derived from these simple formulæ, I take in this abstract the following, viz.:

$$\iint V . (V . \sigma U \nu) \tau ds = \iint \sigma S . U \nu \tau ds - \iint U \nu S . \sigma \tau ds,$$

where by (c) and (a) we see that the right-hand member may be written

$$\begin{aligned} &= \iiint (S . (\tau \nabla) \sigma + \sigma S . \nabla \tau - \nabla S . \sigma \tau) ds \\ &= - \iiint V . V (\nabla \sigma) \tau ds \dots\dots\dots(d). \end{aligned}$$

This, and similar formulæ, are applied in the paper to find the potential and vector-force due to various distributions of magnetism. To show how this is introduced, I briefly sketch the mode of expressing the potential of a distribution.

Let  $\sigma$  be the vector expressing the direction and intensity of magnetisation, per unit of volume, at the element  $ds$ . Then if the magnet be placed in a field of magnetic force whose potential is  $u$ , we have for its potential energy

$$\begin{aligned} E &= -\iiint S(\sigma \nabla) u ds \\ &= \iiint u S(\nabla \sigma) ds - \iint u S \cdot U \nu \sigma ds. \end{aligned}$$

This shows at once that the magnetism may be resolved into a volume-density  $S(\nabla \sigma)$ , and a surface-density  $-S \cdot U \nu \sigma$ . Hence, for a solenoidal distribution,

$$S \cdot \nabla \sigma = 0.$$

What Thomson has called a lamellar distribution (*Phil. Trans.* 1852), obviously requires that

$$S \cdot \sigma d\rho$$

be integrable without a factor; *i.e.*, that

$$V \cdot \nabla \sigma = 0.$$

A complex lamellar distribution requires that the same expression be integrable by the aid of a factor. If this be  $u$ , we have at once

$$V \cdot \nabla (u \sigma) = 0,$$

or

$$S \cdot \sigma \nabla \sigma = 0.$$

We see at once that ( $d$ ) may be written

$$-\iint V \cdot (V \cdot \sigma U \nu) \tau ds = -\iiint V \cdot \tau V \cdot \nabla \sigma ds - \iiint V \cdot \sigma \nabla \tau ds + \iiint S \sigma \nabla \cdot \tau ds.$$

Now, if  $\tau = \nabla \left( \frac{1}{r} \right)$ , where  $r$  is the distance between any external point and the element  $ds$ , the last term on the right is the vector-force exerted by the magnet on a unit pole placed at the point. The second term on the right vanishes by Laplace's equation, and the first vanishes as above if the distribution of magnetism be lamellar, thus giving Thomson's result in the form of a surface integral.

Another of the applications made is to Ampère's *Directrice de l'action électro-dynamique*, which (No. III. above, § 5) is the vector-integral

$$\int \frac{V \rho d\rho}{T \rho^3},$$

where  $d\rho$  is an element of a closed circuit, and the integration extends round the circuit. This leads again to the consideration of relations between single and double integrals, as in Part I. of this paper.

Returning to the electrodynamic integral, note that it may be written

$$-\int V \cdot (d\rho \nabla) \frac{1}{r},$$

so that, by one of the last formulæ of Part I. above, its value as a surface integral is

$$\iint S \cdot U \nu \nabla \cdot \nabla \frac{1}{r} ds - \iint U \nu \nabla^2 \frac{1}{r} ds.$$

Of this the last term vanishes, unless the origin is in, or infinitely near to, the surface over which the double integration extends. The value of the first term is seen (by what precedes) to be the vector-force due to uniform normal magnetisation of the same surface.

Again, since 
$$\nabla U\rho = -\frac{2}{T\rho},$$

we obtain at once 
$$-2 \iiint \frac{dS}{T\rho} = \iint S \cdot U\rho U\nu ds,$$

whence, by differentiation, or by putting  $\rho + \alpha$  for  $\rho$ , and expanding in ascending powers of  $T\alpha$  (both of which tacitly assume that the origin is external to the space integrated through, *i.e.*, that  $T\rho$  nowhere vanishes), we have

$$-2 \iiint \frac{dS U\rho}{T\rho^2} = \iint \frac{V \cdot U\rho V \cdot U\nu U\rho}{T\rho} ds = 2 \iint \frac{U\nu ds}{T\rho}; \text{ (by (a));}$$

and this, again, involves

$$\iint \frac{U\nu ds}{T\rho} = \iint \frac{U\rho}{T\rho} S \cdot U\nu U\rho ds.$$

The interpretation of these, and of more complex formulæ of a similar kind, leads to many curious theorems in attraction and in potentials. Thus, from (a) we have

$$\iiint \frac{\nabla t}{T\rho} ds - \iiint \frac{t U\rho}{T\rho^2} ds = \iint \frac{t U\nu}{T\rho} ds,$$

which gives the attraction of a mass of density  $t$  in terms of the potentials of volume distributions and surface distributions. Putting

$$\sigma = it_1 + jt_2 + kt_3,$$

this becomes 
$$\iiint \frac{\nabla \sigma ds}{T\rho} - \iiint \frac{U\rho \cdot \sigma ds}{T\rho^2} = \iint \frac{U\nu \cdot \sigma ds}{T\rho}.$$

By putting  $\sigma = \rho$ , and taking the scalar, we recover a formula given above; and by taking the vector we have

$$V \iint U\nu U\rho ds = 0.$$

This may be easily verified from the formula

$$\int P d\rho = V \iint U\nu \cdot \nabla P ds,$$

by remembering that

$$\nabla T\rho = U\rho.$$

Again if, in the fundamental integral, we put

$$\sigma = t U\rho,$$

we have 
$$\iiint \frac{S(\rho \nabla) t}{T\rho} ds - 2 \iiint \frac{t dS}{T\rho} = \iint t S \cdot U\nu U\rho ds.$$

## XXIII.

## ADDRESS TO SECTION A OF THE BRITISH ASSOCIATION.

[*British Association Report, Edinburgh, August 3rd, 1871.*]

IN opening the proceedings of this Section my immediate predecessors have exercised their ingenuity in presenting its widely differing component subjects from their several points of view, and in endeavouring to coordinate them. What they were obliged to leave unfinished, it would be absurd in me to attempt to complete. It would be impossible, also, in the limits of a brief address to give a detailed account of the recent progress of physical and mathematical knowledge. Such a work can only be produced by separate instalments, each written by a specialist, such as the admirable "Reports" which form from time to time the most valuable portions of our annual volume.

I shall therefore confine my remarks in the main to those two subjects, one in the mathematical, the other in the purely physical division of our work, which are comparatively familiar to myself. I wish, if possible, to induce, ere it be too late, native mathematicians to pay much more attention than they have yet paid to Hamilton's magnificent Calculus of Quaternions, and to call the particular notice of physicists to our President's grand Principle of Dissipation of Energy. I think that these are, at this moment, the most important because the most promising parts of our field.

If nothing more could be said for Quaternions than that they enable us to exhibit in a singularly compact and elegant form, whose meaning is obvious at a glance on account of the utter inartificiality of the method, results which in the ordinary Cartesian coordinates are of the utmost complexity, a very powerful argument for their use would be furnished. But it would be unjust to Quaternions to be content with such a statement; for we are fully entitled to say that in *all* cases, even in those to which

the Cartesian methods seem specially adapted, they give as simple an expression as any other method; while in the great majority of cases they give a vastly simpler one. In the common methods a judicious choice of coordinates is often of immense importance in simplifying an investigation; in Quaternions there is usually *no choice*, for (except when they degrade to mere scalars) they are in general utterly independent of any particular directions in space, and select of themselves the most natural reference lines for each particular problem. This is easily illustrated by the most elementary instances, such as the following:—The general equation of Cones involves merely the *direction* of the vector of a point, while that of Surfaces of Revolution is a relation between the *lengths* of that vector and of its resolved part parallel to the axis; and Quaternions enable us by a mere mark to separate the ideas of length and direction without introducing the cumbrous and clumsy square roots of sums of squares which are otherwise necessary.

But, as it seems to me that mathematical methods should be specially valued in this Section as regards their fitness for physical applications, what can possibly from that point of view be more important than Hamilton's  $\nabla$ ? Physical analogies have often been invoked to make intelligible various mathematical processes. Witness the case of Statical Electricity, wherein Thomson has, by the analogy of Heat-conduction, explained the meaning of various important theorems due to Green, Gauss, and others; and wherein Clerk-Maxwell has employed the properties of an imaginary incompressible liquid (devoid of inertia) to illustrate not merely these theorems, but even Thomson's Electrical Images. [In fact he has gone much further, having applied his analogy to the puzzling combinations presented by Electrodynamics.] There can be little doubt that these comparisons owe their birth to the small intelligibility, *per se*, of what has been called Laplace's Operator,  $\frac{d^2}{dx^2} + \frac{d^2}{dy^2} + \frac{d^2}{dz^2}$ , which appears alike in all theories of attraction at a distance, in the steady flow of heat in a conductor, and in the steady motion of incompressible fluids. But when we are taught to understand the operator itself we are able to dispense with these analogies, which, however valuable and beautiful, have certainly to be used with extreme caution, as tending very often to confuse and mislead. Now Laplace's operator is merely the negative of the *square* of Hamilton's  $\nabla$ , which is perfectly intelligible in itself and in all its combinations; and can be defined as giving the vector-rate of most rapid increase of any scalar function to which it is applied—giving, for instance, the vector-force from a potential, the heat-flux from a distribution of temperature, &c. Very simple functions of the same operator give the rate of increase of a quantity in any assigned direction, the condensation and elementary rotation produced by given displacements of the parts of a system, &c. For instance, a very elementary application of  $\nabla$  to the theory of attraction enables us to put one of its fundamental principles in the following extremely suggestive form:—If the displacement or velocity of each particle of a medium represent in magnitude and direction the electric force at that particle, the corresponding statical distribution of electricity is proportional everywhere to the condensation thus produced. Again, Green's celebrated theorem is at once seen to be merely the well-known equation of continuity expressed for a heterogeneous fluid, whose density at every point is

proportional to one electric potential, and its displacement or velocity proportional to and in the direction of the electric force due to another potential. But this is not the time to pursue such an inquiry, for it would lead me at once to discussions as to the possible nature of electric phenomena and of gravitation. I believe myself to be fully justified in saying that, were the theory of this operator thoroughly developed and generally known, the whole mathematical treatment of such physical questions as those just mentioned would undergo an immediate and enormous simplification; and this, in its turn, would be at once followed by a proportionately large extension of our knowledge\*.

And this is but *one* of the claims of Quaternions to the attention of physicists. When we come to the important questions of stress and strain in an elastic solid, we find again that all the elaborate and puzzling machinery of coordinates commonly employed can be at once comprehended and kept out of sight in a mere single symbol—a linear and vector function, which is self-conjugate if the strain be pure. This is simply, it appears to me, a proof either that the elaborate machinery ought never to have been introduced, or that its use was an indication of a comparatively savage state of mathematical civilization. In the motion of a rigid solid about a fixed point, a quaternion, represented by a single symbol which is a function of the time, gives us the operator which could bring the body by a single rotation from its initial position to its position at any assigned instant. In short, whenever with our usual means a result can be obtained in, or after much labour reduced to, a simple form, Quaternions will give it at once in that form; so that nothing is ever *lost* in point of simplicity. On the other hand, in numberless cases the Quaternion result is immeasurably simpler and more intelligible than any which can be obtained or even *expressed* by the usual methods. And it is not to be supposed that the modern Higher Algebra, which has done so much to simplify and extend the ordinary Cartesian methods, would be ignored by the general employment of Quaternions; on the contrary,

\* The following extracts from letters of Sir W. R. Hamilton have a perfectly general application, so that I do not hesitate to publish them:—"De Morgan was the very *first* person to *notice* the Quaternions *in print*; namely in a Paper on Triple Algebra, in the *Camb. Phil. Trans.* of 1844. It was, I think, about that time, or not very long afterwards, that he wrote to me, nearly as follows:—"I suspect, Hamilton, that you have *caught the right sow by the ear!*" Between us, dear Mr Tait, I think that *we shall begin the SHEARING of it!*" "You might without offence to me, consider that I abused the license of *hope*, which may be indulged to an inventor, if I were to confess that I expect the Quaternions to supply, hereafter, not merely *mathematical methods*, but also *physical suggestions*. And, in particular, you are quite welcome to smile if I say that it does not seem extravagant to *me* to suppose that a *full* possession of those *à priori principles* of mine, about the *multiplication of vectors* (including the Law of the Four Scales and the conception of the Extra-spatial Unit), which have as yet been not much more than *hinted* to the public, MIGHT have led (I do not at all mean that *in my hands* they ever *would* have done so) to an ANTICIPATION of the great discovery of OERSTED."

"It appears to me that one, and not the least, of the services which quaternions may be expected to do to mathematical analysis generally, is that their introduction will *compel* those who adopt them (or even who admit that they *may* be reasonably adopted by other persons) to consider, or to admit that others may usefully inquire, *what common grounds* can be established for *conclusions common to quaternions* and to older branches of mathematics."

"*Could* any thing be simpler or more satisfactory? Don't you *feel*, as well as think, that we are on a *right track*, and shall be *thanked* hereafter? Never mind when."



Determinants, Invariants, &c. present themselves in almost every Quaternion solution, and in forms which have received the full benefit of that simplification which Quaternions generally produce. Comparing a Quaternion investigation, no matter in what department, with the equivalent Cartesian one, even when the latter has availed itself to the utmost of the improvements suggested by Higher Algebra, one can hardly help making the remark that they contrast even more strongly than the decimal notation with the binary scale or with the old Greek Arithmetic, or than the well-ordered subdivisions of the metrical system with the preposterous no-systems of Great Britain, a mere fragment of which (in the form of Tables of Weights and Measures) forms perhaps the most effective, if not the most ingenious, of the many instruments of torture employed in our elementary teaching.

It is true that, in the eyes of the pure mathematician, Quaternions have one grand and fatal defect. They cannot be applied to space of  $n$  dimensions, they are contented to deal with those poor three dimensions in which mere mortals are doomed to dwell, but which cannot bound the limitless aspirations of a Cayley or a Sylvester. From the physical point of view this, instead of a defect, is to be regarded as the greatest possible recommendation. It shows, in fact, Quaternions to be a special instrument so constructed for application to the *Actual* as to have thrown overboard everything which is not absolutely necessary, without the slightest consideration whether or no it was thereby being rendered useless for applications to the *Inconceivable*.

The late Sir John Herschel was one of the first to perceive the value of Quaternions; and there may be present some who remember him, at a British Association Meeting not long after their invention, characterizing them as a "Cornucopia from which, turn it how you will, something valuable is sure to fall." Is it not strange, to use no harsher word, that such a harvest has hitherto been left almost entirely to Hamilton himself? If but half a dozen tolerably good mathematicians, such as exist in scores in this country, were seriously to work at it, instead of spending (or rather wasting) their time, as so many who have the requisite leisure now do, in going over again what has been already done, or in working out mere details where a grand theory has been sketched, a very great immediate advance would be certain. From the majority of the papers in our few mathematical journals one would almost be led to fancy that British mathematicians have too much pride to use a simple method while an unnecessarily complex one can be had. No more telling example of this could be wished for than the insane delusion under which they permit Euclid to be employed in our elementary teaching. They seem voluntarily to weight alike themselves and their pupils for the race; and a cynic might, perhaps without much injustice, say they do so that they may have mere self-imposed and avoidable difficulties to face instead of the new, real, and dreaded ones (belonging to regions hitherto unpenetrated) with which Quaternions would too soon enable them to come into contact. But this game will certainly end in disaster. As surely as Mathematics came to a relative stand-still in this country for nearly a century after Newton, so surely will it do so again if we leave our eager and watchful rivals abroad to take the initiative in developing the grand method of Hamilton. And it is not alone French and Germans

whom we have now to dread, Russia, America, regenerated Italy, and other nations are all fairly entered for the contest.

The flights of the imagination which occur to the pure mathematician are in general so much better described in his formulæ than in words, that it is not remarkable to find the subject treated by outsiders as something essentially cold and uninteresting, while even the most abstruse branches of physics, as yet totally incapable of being popularized, attract the attention of the uninitiated. The reason may perhaps be sought in the fact that, while perhaps the only successful attempt to invest mathematical reasoning with a halo of glory—that made in this Section by Prof. Sylvester—is known to a comparative few, several of the highest problems of physics are connected with those simple observations which are possible to the many. The smell of lightning has been observed for thousands of years, it required the sagacity of Schönbein to trace it to the formation of Ozone. Not to speak of the (probably fabulous) apple of Newton, what enormous consequences did he obtain by passing light through a mere wedge of glass, and by simply laying a lens on a flat plate! The patching of a trumpety model led Watt to his magnificent inventions. As children at the sea-shore playing with a “roaring buckie,” or in later life lazily puffing out rings of tobacco-smoke, we are illustrating two of the splendid researches of Helmholtz. And our President, by the bold, because simple, use of reaction instead of action, has eclipsed even his former services to the Submarine Telegraph, and given it powers which but a few years ago would have been deemed unattainable.

In experimental Physics our case is not hopeless, perhaps not as yet even alarming. Still something of the same kind may be said in this as in pure Mathematics. If Thomson's Theory of Dissipation, for instance, be not speedily developed in this country, we shall soon learn its consequences from abroad. The grand test of our science, the proof of its being a reality and not a mere inventing of new terms and squabbling as to what they shall mean, is that it is ever advancing. There is no standing still; there is no running round and round as in a beaten donkey-track, coming back at the end of a century or so into the old positions, and fighting the self-same battles under slightly different banners, which is merely another form of stagnation (Kinetic Stability in fact). “A little folding of the hands to sleep,” in chuckling satisfaction at what has been achieved of late years by our great experimenters, and we shall be left hopelessly behind. The sad fate of Newton's successors ought ever to be a warning to us. Trusting to what he had done, they allowed mathematical science almost to die out in this country, at least as compared with its immense progress in Germany and France. It required the united exertions of the late Sir J. Herschel and many others to render possible in these islands a Boole and a Hamilton. If the successors of Davy and Faraday pause to ponder even on *their* achievements, we shall soon be again in the same state of ignominious inferiority. Who will then step in to save us?

Even as it is, though we have among us many names quite as justly great as any that our rivals can produce, we have also (even in our educated classes) such an immense amount of ignorance and consequent credulity, that it seems matter for

surprise that true science is able to exist. Spiritualists, Circle-squarers, Perpetual-motionists, Believers that the earth is flat and that the moon has no rotation, swarm about us. They certainly multiply much faster than do genuine men of science. This is characteristic of all inferior races, but it is consolatory to remember that in spite of it these soon become extinct. Your quack has his little day, and disappears except to the antiquary. But in science nothing of value can ever be lost; it is certain to become a stepping-stone on the way to further truth. Still, when our stepping-stones are laid, we should not wait till others employ them. "Gentlemen of the Guard be kind enough to fire first" is a courtesy entirely out of date; with the weapons of the present day it would be simply suicide.

There is another point which should not be omitted in an address like this. For obvious reasons I must speak of the general question only, not venturing on examples, though I could give many telling ones. Even among our greatest men of science in this country there is comparatively little knowledge of what has been already achieved, except of course in the one or more special departments cultivated by each individual. There can be little doubt that one cause at least of this is to be sought in the extremely meagre interest which our statesmen, as a rule, take in scientific progress. While abroad we find half a dozen professors teaching parts of the same subject in one University (each having therefore reasonable leisure), with us one man has to do the whole, and to endeavour as he best can to make something out of his very few spare moments. Along with this, and in great part due to it, there is often found a proneness to believe that what seems evident to the thinker cannot but have been long known to others. Thus the credit of many valuable discoveries is lost to Britain because her philosophers, having no time to spare, do not know that they are discoveries. The scientific men of other nations are, as a rule, better informed [certainly far better encouraged and less over-worked], and perhaps likewise are not so much given to self-depreciation. Until something resembling the 'Fortschritte der Physik,' but in an improved form, and published at smaller intervals and with much less delay, is established in this country, there is little hope of improvement in this respect. Why should science be imperfectly summarized in little haphazard scraps here and there, when mere property has its elaborate series of Money-articles and exact Broker's Share-lists? Such a work would be very easy of accomplishment: we have only to begin boldly; we do not need to go back, for in every year good work is being done at almost every part of the boundary between, as it were, the cultivated land and the still unpenetrated forest—enough at all events to show with all necessary accuracy whereabouts that boundary lies.

There is no need of entering here on the question of Conservation of Energy; it is thoroughly accepted by scientific men, and has revolutionized the greater part of Physics. The facts as to its history also are generally agreed upon, but differences of a formidable kind exist as to the deductions to be drawn from them. These are matters, however, which will be more easily disposed of thirty years hence than now. The Transformation of Energy is also generally accepted, and, in fact, under various unsatisfactory names was almost popularly known before the Conservation of Energy

was known in its entirety to more than a very few. But the Dissipation of Energy is by no means well known, and many of the results of its legitimate application have been received with doubt, sometimes even with attempted ridicule. Yet it appears to be at the present moment by far the most promising and fertile portion of Natural Philosophy, having obvious applications of which as yet only a small percentage appear to have been made. Some, indeed, were made before the enunciation of the Principle, and have since been recognized as instances of it. Of such we have good examples in Fourier's great work on Heat-conduction, in the optical theorem that an image can never be brighter than the object, in Gauss's mode of investigating electrical distribution, and in some of Thomson's theorems as to the energy of an electromagnetic field. But its discoverer has, so far as I know, as yet confined himself in its explicit application to questions of Heat-conduction and Restoration of Energy, Geological Time, the Earth's Rotation, and such like. Unfortunately his long-expected Rede Lecture has not yet been published, and its contents (save to those who were fortunate enough to hear it) are still almost entirely unknown.

But there can be little question that the Principle contains implicitly the whole theory of Thermo-electricity, of Chemical Combination, of Allotropy, of Fluorescence, &c., and perhaps even of matters of a higher order than common physics and chemistry. In Astronomy it leads us to the grand question of the *age*, or perhaps more correctly the *phase of life*, of a star or nebula, shows us the material of potential suns, other suns in the process of formation, in vigorous youth, and in every stage of slowly protracted decay. It leads us to look on each planet and satellite as having been at one time a tiny sun, a member of some binary or multiple group, and even now (when almost deprived, at least at its surface, of its original energy) presenting an endless variety of subjects for the application of its methods. It leads us forward in thought to the far-distant time when the materials of the present stellar system shall have lost all but their mutual potential energy, but shall in virtue of it form the materials of future larger suns with their attendant planets. Finally, as it alone is able to lead us, by sure steps of deductive reasoning, to the necessary future of the universe—necessary, that is, if physical laws for ever remain unchanged—so it enables us distinctly to say that the present order of things has *not* been evolved through infinite past time by the agency of laws now at work, but must have had a distinctive beginning, a state beyond which we are totally unable to penetrate, a state, in fact, which must have been produced by other than the now acting causes.

Thus also, it is possible that in Physiology it may, ere long, lead to results of a different and much higher order of novelty and interest than those yet obtained, immensely valuable though they certainly are.

It was a grand step in science which showed that just as the consumption of fuel is necessary to the working of a steam-engine, or to the steady light of a candle, so the living engine requires food to supply its expenditure in the forms of muscular work and animal heat. Still grander was Rumford's early anticipation that the animal is a more economic engine than any lifeless one we can construct. Even in the

explanation of this there is involved a question of very great interest, still unsolved, though Joule and many other philosophers of the highest order have worked at it. Joule has given a suggestion of great value, viz. that the animal resembles an electro-magnetic- rather than a heat-engine; but this throws us back again upon our difficulties as to the nature of electricity. Still, even supposing this question fully answered, there remains another—perhaps the highest which the human intellect is capable of directly attacking, for it is simply preposterous to suppose that we shall ever be able to understand scientifically the source of Consciousness and Volition, not to speak of loftier things—there remains the question of Life. Now it may be startling to some of you, especially if you have not particularly considered the matter, to hear it surmised that possibly we may, by the help of physical principles, especially that of the Dissipation of Energy, some time attain to a notion of what constitutes Life—mere Vitality I repeat, nothing higher. If you think for a moment of the vitality of a plant or a zoophyte, the remark perhaps will not appear so strange after all. But do not fancy that the Dissipation of Energy to which I refer is at all that of a watch or such-like piece of mere human mechanism, dissipating the low and common form of energy of a single coiled spring. It must be such that every little part of the living organism has its own store of energy constantly being dissipated, and as constantly replenished from external sources drawn upon by the whole arrangement in their harmonious working together. As an illustration of my meaning, though an extremely inadequate one, suppose Vaucanson's Duck to have been made up of excessively small parts, each microscopically constructed as perfectly as was the comparatively coarse whole, we should have had something barely distinguishable, save by want of instincts, from the living model. But let no one imagine that, should we ever penetrate this mystery, we shall thereby be enabled to produce, except from life, even the lowest form of life. Our President's splendid suggestion of Vortex-atoms, if it be correct, will enable us thoroughly to understand matter, and mathematically to investigate all its properties. Yet its very basis implies the *absolute necessity* of an intervention of Creative Power to form or to destroy one atom even of dead matter. The question really stands thus:—Is Life physical or no? For if it be in any sense, however slight or restricted, physical, it is to that extent a subject for the Natural Philosopher, and for him alone. It would be entirely out of place for me to discuss such a question as this now and here; I have introduced it merely that I may say a word or two about what has been so often and so persistently croaked against the British Association, viz. that it tends to develope what are called Scientific Heresies. No doubt such charges are brought more usually against other Sections than against this; but Section A has not been held blameless. It seems to me that the proper answer to all such charges will be very simply and easily given, if we merely show that in our reasonings from observation and experiment we invariably confine our physical conclusions strictly to matter and energy (things which we can weigh and measure) in their multiform combinations. Excepting that which is obviously purely mathematical, whatever is certainly neither matter nor energy, nor dependent upon these, *is not a subject to be discussed here*, even by implication. All our reasonings in Physics *must*, so far as we know, be based upon the assumption, founded on experience, that in the universe, whatever be the epoch or the locality, under exactly similar circumstances exactly

similar results will be obtained. If this be not granted there is an end of Physical Science, or, rather, there never could have been such a Science\*. To use the word "Heresy" with reference to purely physical reasonings about Geological Time, or matters of that kind, is nowadays a piece of folly which even Galileo's judges, were they alive, would shrink from, as calculated to damage none but themselves and the cause which of old they, according to their lights, very naturally maintained.

There must always be wide limits of uncertainty (unless we choose to look upon Physics as a necessarily finite Science) concerning the exact boundary between the Attainable and the Unattainable. One herd of ignorant people, with the sole *prestige* of rapidly increasing numbers, and with the adhesion of a few fanatical deserters from the ranks of Science, refuse to admit that all the phenomena even of ordinary dead matter are strictly and exclusively in the domain of physical science. On the other hand, there is a numerous group, not in the slightest degree entitled to rank as Physicists (though in general they assume the proud title of Philosophers), who assert that not merely Life, but even Volition and Consciousness are mere physical manifestations. These opposite errors, into neither of which is it possible for a genuine scientific man to fall, so long at least as he retains his reason, are easily seen to be very closely allied. They are both to be attributed to that Credulity which is characteristic alike of Ignorance and of Incapacity. Unfortunately there is no cure; the case is hopeless, for great ignorance almost necessarily presumes incapacity, whether it show itself in the comparatively harmless folly of the Spiritualist or in the pernicious nonsense of the Materialist.

Alike condemned and contemned, we leave them to their proper fate—oblivion; but still we have to face the question, where to draw the line between that which is physical and that which is utterly beyond physics. And, again, our answer is—Experience alone can tell us; for experience is our only possible guide. If we attend earnestly and honestly to its teachings, we shall never go far astray. Man has been left to the resources of his intellect for the discovery not merely of physical laws, but of how far he is capable of comprehending them. And our answer to those who denounce our legitimate studies as heretical is simply this,—A revelation of any thing which we can discover for ourselves, by studying the ordinary course of nature, would be an absurdity.

A profound lesson may be learned from one of the earliest little papers of our President, published while he was an undergraduate at Cambridge, where he shows that Fourier's magnificent treatment of the Conduction of Heat leads to formulæ for its distribution which are intelligible (and of course capable of being fully verified by

\* It might be possible, and, if so, perhaps interesting, to speculate on the results of secular changes in physical laws, or in particles of matter which are subject to them, but (so far as experience, which is our *only* guide, has taught us since the beginning of modern science) there seems no trace of such. Even if there were, as these changes must be of necessity extremely slow (because not yet even suspected), we may reasonably expect, from the analogy of the history of such a question as gravitation, especially in the discovery of Neptune, that our work, far from becoming impossible, will merely become considerably more difficult as well as more laborious, but, on that account, all the more creditable when successfully carried out.

experiment) for all time future, but which, except in particular cases, when extended to time past, remain intelligible for a finite period only, and *then* indicate a state of things which could not have resulted under known laws from any conceivable previous distribution. So far as heat is concerned, modern investigations have shown that a previous distribution of the *matter* involved may, by its potential energy, be capable of producing such a state of things at the moment of its aggregation; but the example is now adduced not for its bearing on heat alone, but as a simple illustration of the fact that all portions of our Science, and especially that beautiful one the Dissipation of Energy, point unanimously to a beginning, to a state of things incapable of being derived by present laws from any conceivable previous arrangement.

I conclude by quoting some noble words used by Stokes in his Address at Exeter, words which should be stereotyped for every Meeting of this Association:—"When from the phenomena of life we pass on to those of mind, we enter a region still more profoundly mysterious.....Science can be expected to do but little to aid us here, since the instrument of research is itself the object of investigation. It can but enlighten us as to the depth of our ignorance, and lead us to look to a higher aid for that which most nearly concerns our wellbeing."

## XXIV.

## NOTE ON A SINGULAR PROPERTY OF THE RETINA.

[*Proceedings of the Royal Society of Edinburgh, Jan. 15, 1872.*]

WHILE suffering some of the annoyances seemingly inseparable from re-vaccination at too advanced an age, I was led to the curious observation presently to be described. I was unable to sleep, except in "short and far between" dozes, from which I woke with a sudden start, my eyelids opening fully. I found by trial that this state of things became somewhat less intolerable when I lay on my back, with my head considerably elevated. In this position I directly faced a gas jet, burning not very brightly, placed close to a whitish wall, and surrounded by a ground glass shade, through which the flame could be prominently perceived. The portions of the wall surrounding the burner were moderately illuminated, and hyperbolic portions above and below somewhat more strongly. I observed, on waking, that the gas flame seemed for a second or two to be surrounded by a dark crimson ground, though itself apparently unchanged in colour. Gradually, after the lapse of, at the very utmost, a couple of seconds, everything resumed its normal appearance. As this phenomenon appeared not only to be worthy of observation in itself, but to furnish me with something definite to reflect upon, which is far the best alleviation of annoyances similar to those from which I was suffering, I determined to watch it, transitory as it was, feeling assured that I should have many opportunities of observing it. After two nights' practice, I found myself getting dangerously skilful in reproducing it, and decided somewhat reluctantly, that I must give it up. What I observed, however, has already been almost completely described as having been seen on the very first occasion. I endeavoured to prepare myself to note any possible difference of colour in the crimson field, as distinguished from mere difference of intensity of illumination, and I could perceive none. I also endeavoured to ascertain the nature of the transition from this state to the normal one, but this was so



exceedingly rapid that I could form no conclusion, and I found that under the necessary circumstances of the observation, viz., as it could be made only at the instant of awakening, it was impossible for me to estimate, even approximately, the duration of the crimson appearance.

Several possible modes of explaining the phenomenon at once occurred to me. Of these, however, I shall mention but three, and give reasons for rejecting two of them, while not pretending to specify them in the order in which they occurred to me. It cannot be ascribed to any visual defects in my eyes, which are normal as to colour sensations, and very perfect optically. *1st*, I imagined it might be due to light passing through the almost closed eyelid, or through a portion of the eyeball temporarily filled with blood. Besides feeling certain that my eyes were fully open, I had the additional argument against this explanation, that I could not reproduce the phenomenon by carefully and gradually closing them, and that I am not aware that an effusion of blood in any part of the eye could possibly disappear so rapidly. *2nd*, It might be due to diffraction either by my eyelashes or by small particles, whether on the cornea or in the transparent substances of the eye, coarse enough to produce nearly the same tint for some distance round the flame. This is negatived by several considerations, among which (in addition to those urged against the preceding explanation) it is only necessary to mention again the facts, that the colour is not one which can be produced by diffraction under such circumstances, and that it appeared to be the same on the more illuminated, as well as on the darker part of the field. *3rd*, I suggest, as a possible explanation, but one which is more specially in the province of the physiologist than of the natural philosopher, that the retina (or the nerve cells connected with it?) partakes of sleep with the other nerve cells, by which that phenomenon has been accounted for, and that on a sudden awakening, the portions connected with the lowest of the primary forms of colour are the first to come into action, the others coming into play somewhat later, and almost simultaneously. This would completely account for the peculiar crimson colour, and for its uniformity of tint over the whole field, excepting the gas flame itself, the comparative intensity of whose light may easily be supposed to have simultaneously aroused all the three sensations in the small portion of the retina on which it fell, though it is just possible that it also may have appeared crimson for an exceedingly short period. I am not aware of any experiments or observations having been made with reference to the subject of this note, and I hope to have no further opportunities of making them, at least in the way in which these were made, but the point is a curious one, and worthy of the careful attention of all who may be forced to consider it. Professor Clerk-Maxwell informs me that he and others have observed that the lowest of the three colour sensations is the first to evanesce with faintness of light, and that it has been asserted to be the most sluggish in responding to the sudden appearance of light. This, however, is not necessarily antagonistic to my explanation, but will rather, if my explanation be correct, tend to show a greater interval between the awakening of the red, and that of the other colour sensations than that above hinted at.

## XXV.

## ON ORTHOGONAL ISOTHERMAL SURFACES. PART I.

[*Trans. R. S. E.* 1873-4. Read *Jan. 2*, 1866; Revised and Improved, *Jan. 15*, 1872.]

THE following pages contain, in a comparatively compact form, part of the substance of a voluminous paper read to the Society six years ago. Of that paper, which employed ordinary analysis alone, only a few pages had been put in type when I succeeded in overcoming a formidable difficulty which had presented itself in my quaternion treatment of the subject. I therefore withdrew the paper in order that it might have the benefit of the simplification which quaternions always give; but it is only of late that I have found time to complete part of the translation into the new language. From the circumstances under which the paper has thus been produced,  $i, j, k$  come forward with undue prominence, a thing to be regarded (in Hamilton's words) "as an inelegance and imperfection in this calculus, or rather in the state to which it has hitherto been unfolded." Immense as is the simplification already attained, it is clear that in many places still more is attainable. But I have not postponed my paper till it should receive this final polish, partly because the time I can devote to such inquiries is extremely limited, and partly because I think that several of the results obtained, and of the modes of obtaining them, are new and remarkable. Besides, a question of this order of difficulty is admirably adapted to show in what respects quaternion methods require improvement. There must be some simple mode of deducing (13) and (21) below from (7) without the explicit use of  $i, j, k$ , but I have not yet been fortunate enough to discover it. [This has been, to some extent, supplied in later papers:—Dec. 1877, and Dec. 1892. 1897.]

I append to this introduction, for comparison, a few extracts from the paper in its original form.

a. Let

$$\left(\frac{d\xi}{dx}\right)^2 + \left(\frac{d\xi}{dy}\right)^2 + \left(\frac{d\xi}{dz}\right)^2 \text{ be written } \square\xi,$$

$$\frac{d\xi}{dx} \frac{d\eta}{dx} + \frac{d\xi}{dy} \frac{d\eta}{dy} + \frac{d\xi}{dz} \frac{d\eta}{dz} \quad ,, \quad D(\xi, \eta),$$

and

$$\begin{vmatrix} \frac{d\xi}{dx}, & \frac{d\xi}{dy}, & \frac{d\xi}{dz} \\ \frac{d\eta}{dx}, & \frac{d\eta}{dy}, & \frac{d\eta}{dz} \\ \frac{d\zeta}{dx}, & \frac{d\zeta}{dy}, & \frac{d\zeta}{dz} \end{vmatrix} \quad ,, \quad \Delta(\xi, \eta, \zeta).$$

Then, if

$$D(\xi, \eta) = D(\eta, \zeta) = D(\zeta, \xi) = 0,$$

$$\begin{vmatrix} \frac{d\xi}{dx} & \frac{d\xi}{dy} & \frac{d\xi}{dz} \\ \frac{d\eta}{dy} & \frac{d\eta}{dz} & \frac{d\eta}{dx} \\ \frac{d\zeta}{dy} & \frac{d\zeta}{dz} & \frac{d\zeta}{dx} \end{vmatrix} = \begin{vmatrix} \frac{d\eta}{dz} & \frac{d\eta}{dx} \\ \frac{d\zeta}{dz} & \frac{d\zeta}{dx} \end{vmatrix} = \begin{vmatrix} \frac{d\eta}{dx} & \frac{d\eta}{dy} \\ \frac{d\zeta}{dx} & \frac{d\zeta}{dy} \end{vmatrix},$$

or

$$\frac{\frac{d\xi}{dx}}{\frac{d\Delta}{d\xi}} = \frac{\frac{d\xi}{dy}}{\frac{d\Delta}{d\xi}} = \frac{\frac{d\xi}{dz}}{\frac{d\Delta}{d\xi}} = \frac{1}{u} \text{ suppose,}$$

$$\frac{d\left(\frac{d\xi}{dx}\right)}{d\left(\frac{d\xi}{dx}\right)} = \frac{d\left(\frac{d\xi}{dy}\right)}{d\left(\frac{d\xi}{dy}\right)} = \frac{d\left(\frac{d\xi}{dz}\right)}{d\left(\frac{d\xi}{dz}\right)}$$

with two similar sets in  $\eta$  and  $\zeta$ .

b. Since

$$\Delta = \frac{d\xi}{dx} \frac{d\Delta}{d\left(\frac{d\xi}{dx}\right)} + \frac{d\xi}{dy} \frac{d\Delta}{d\left(\frac{d\xi}{dy}\right)} + \frac{d\xi}{dz} \frac{d\Delta}{d\left(\frac{d\xi}{dz}\right)},$$

we have at once

$$\Delta = u \square\xi = v \square\eta = w \square\zeta.$$

Hence

$$u = \frac{\frac{d\Delta}{d\left(\frac{d\xi}{dx}\right)}}{\frac{d\xi}{dx}} = \frac{\Delta}{\square\xi},$$

or

$$\frac{1}{\Delta} \frac{d\Delta}{d\left(\frac{d\xi}{dx}\right)} d\left(\frac{d\xi}{dx}\right) = \frac{\frac{d\xi}{dx} d\left(\frac{d\xi}{dx}\right)}{\square\xi},$$

which gives by integration

$$\log \Delta = C + \frac{1}{2} \log \square\xi.$$

Thus, finally,

$$\Delta = \sqrt{\square\xi \square\eta \square\zeta}.$$

c. Thus we have

$$u = \sqrt{\frac{\square\eta \square\zeta}{\square\xi}}, \text{ \&c.}$$

But, identically,

$$\frac{d}{dx} \cdot \frac{d\Delta}{d\left(\frac{d\xi}{dx}\right)} + \frac{d}{dy} \cdot \frac{d\Delta}{d\left(\frac{d\xi}{dy}\right)} + \frac{d}{dz} \cdot \frac{d\Delta}{d\left(\frac{d\xi}{dz}\right)} = 0,$$

or 
$$\frac{d}{dx} \left( u \frac{d\xi}{dx} \right) + \frac{d}{dy} \left( u \frac{d\xi}{dy} \right) + \frac{d}{dz} \left( u \frac{d\xi}{dz} \right) = 0,$$

or 
$$u \nabla^2 \xi - D(u, \xi) = 0,$$

with similar equations in  $v, \eta$  and  $w, \zeta$ .

*d.* Now if  $\xi=c$  be one of a system of surfaces isothermal as well as orthogonal, we must have, by the above equation,

$$D(u, \xi) = 0,$$

But the orthogonality gives 
$$D(\eta, \xi) = 0, \quad D(\zeta, \xi) = 0,$$

and the elimination of  $\xi$  among these three equations gives  $\Delta(u, \eta, \zeta) = 0$ , *i.e.* by the property of functional determinants,  $u$  is a function of  $\eta$  and  $\zeta$  alone. Thus we have

$$\sqrt{\frac{\square \eta \square \zeta}{\square \xi}} = f(\eta, \zeta),$$

a well-known relation, &c.

1. Consider the equation 
$$T \cdot \{\phi + f(h)\}^{-1} \sigma = 1,$$

or, as it may be written, 
$$S \cdot \sigma \{\phi + f(h)\}^{-1} \sigma = -1 \dots \dots \dots (1),$$

where  $\phi$  is any self-conjugate linear and vector function, of which  $i, j, k$  are the principal vector directions. We assume that the roots of Hamilton's equation

$$M_g = 0$$

are finite and different from one another, so that cylinders, surfaces of revolution, &c., are excluded from (1).

For any assigned value of  $\sigma$ , (1) gives in general three values of  $f(h)$  and therefore of  $h$ . Omitting for the present the consideration that each value of  $f(h)$  may give more than one value of  $h$ , these values may be any assigned functions of the position of a point in space; because, when they and the function  $f$  are assigned, the squares of the constituents of  $\sigma$  (or, what comes to the same thing, the values of  $\sigma^2, S\sigma\phi\sigma, S\sigma\phi^2\sigma$ ) can at once be found in terms of them, by a system of three *linear* equations.

In this first part I confine myself to cases in which each of these squares is positive, so as to avoid for the present the use of biquaternions.

2. For any assigned constant value of  $h$ , (1) represents in general a surface whose normal vector,  $\nabla h$ , is given by

$$f'(h) \nabla h S \cdot \sigma \psi^{-2} \sigma = 2 \Sigma \left( i S \cdot \frac{d\sigma}{dx} \psi^{-1} \sigma \right) \dots \dots \dots (2),$$

$\psi$  being written for convenience in place of  $\phi + f(h)$ .

Now if  $h_1, h_2$  be the other two values of  $h$  given by (1) for a particular value of  $\sigma$ , the conditions of orthogonality of the surfaces  $h, h_1, h_2$ , are of the form

$$0 = S \cdot \nabla h \nabla h_1 = \Sigma \cdot S \cdot \frac{d\sigma}{dx} \psi^{-1} \sigma S \cdot \frac{d\sigma}{dx} \psi_1^{-1} \sigma \dots\dots\dots(3),$$

where  $\psi_1 = \phi + f(h_1)$ .

3. The three equations (3) may be put in the new form

$$S \cdot \psi^{-1} \sigma \Sigma \left( \frac{d\sigma}{dx} S \cdot \frac{d\sigma}{dx} \psi_1^{-1} \sigma \right) = 0, \text{ \&c.},$$

whence  $\Sigma \left( \frac{d\sigma}{dx} S \cdot \frac{d\sigma}{dx} \psi^{-1} \sigma \right) \parallel V \cdot \psi_1^{-1} \sigma \psi_2^{-1} \sigma \dots\dots\dots(4)$ .

4. But, by the nature of self-conjugate linear and vector functions,

$$S \cdot \psi^{-1} \sigma \psi_1^{-1} \sigma = S \cdot \sigma \psi^{-1} \psi_1^{-1} \sigma = \frac{1}{f(h_1) - f(h)} S \cdot \sigma (\psi^{-1} - \psi_1^{-1}) \sigma = 0 \dots\dots\dots(5),$$

with two other equations of the same kind. These give (when the values of  $h$  are different) three equations of the form

$$\psi^{-1} \sigma \parallel V \cdot \psi_1^{-1} \sigma \psi_2^{-1} \sigma \dots\dots\dots(6),$$

where, of course, we may dispense with the  $V$ .

5. By (4) and (6) we see that we have three equations of the form

$$\psi^{-1} \sigma \parallel \Sigma \left( \frac{d\sigma}{dx} S \cdot \frac{d\sigma}{dx} \psi^{-1} \sigma \right),$$

and these show at once that  $\frac{d\sigma}{dx}, \frac{d\sigma}{dy}, \frac{d\sigma}{dz}$  are rectangular vectors whose tensors are equal. For

$$\tau S \cdot \alpha \beta \gamma = \alpha S \cdot \beta \gamma \tau + \beta S \cdot \gamma \alpha \tau + \gamma S \cdot \alpha \beta \tau$$

is the *only* decomposition of  $\tau$  parallel to  $\alpha, \beta, \gamma$  respectively; and we have here the equation

$$\tau \parallel \alpha S \alpha \tau + \beta S \beta \tau + \gamma S \gamma \tau,$$

holding good for the three non-coplanar vectors  $\psi^{-1} \sigma, \psi_1^{-1} \sigma, \psi_2^{-1} \sigma$ , and therefore true for all vectors. Hence we must have

$$\alpha \parallel V \beta \gamma, \quad \beta \parallel V \gamma \alpha, \quad \gamma \parallel V \alpha \beta,$$

of which any two include the third as a necessary consequence, and in all three of which the coefficient of proportionality is evidently the same. The only exception to this is when

$$\frac{d\sigma}{dx} \parallel \psi^{-1} \sigma, \text{ \&c.}$$

But, in this case, by (2)  $\nabla h \parallel i, \text{ \&c.},$

and we have series of rectangular planes.

6. Hence there must exist a scalar function  $u$ , and a quaternion  $q$  (which may obviously be taken as a mere versor), such that

$$\frac{d\sigma}{dx} = uqi q^{-1}, \text{ \&c.,}$$

or, in one expression,

$$d\sigma = uq d\rho q^{-1} \dots\dots\dots(7).$$

Thus it appears that, in order that (1) (with the limitations above imposed) may represent a triple series of orthogonal surfaces,  $\sigma$  must be such a function of  $\rho$  that, if the extremities of a set of values of  $\rho$  form the corners of an indefinitely small cube, those of the corresponding values of  $\sigma$  (drawn from a common origin) form the corners of another such cube; and that, therefore, the passage from  $\rho$  to  $\sigma$  is that from one mode of dividing space into indefinitely small cubes to another.

Whatever, therefore, may be thought of the logic of the investigation above, it is worth while to pursue the inquiry thus suggested, by developing the consequences of the equation (7) to which it has led us.

7. From the equations just written we see that if

$$\sigma = i\xi + j\eta + k\zeta \dots\dots\dots(8),$$

the direction cosines of  $qiq^{-1}$  are

$$\frac{1}{u} \frac{d\xi}{dx}, \quad \frac{1}{u} \frac{d\eta}{dx}, \quad \frac{1}{u} \frac{d\zeta}{dx}.$$

From these, and other six of similar form, we see that the direction cosines of  $i$  referred to  $qiq^{-1}$ ,  $qjq^{-1}$ ,  $qkq^{-1}$  are

$$\frac{1}{u} \frac{d\xi}{dx}, \quad \frac{1}{u} \frac{d\eta}{dy}, \quad \frac{1}{u} \frac{d\zeta}{dz},$$

and similarly for those of  $j$  and  $k$ .

Hence it follows that  $\nabla\xi$ ,  $\nabla\eta$ ,  $\nabla\zeta$  form a set of mutually perpendicular vectors whose common tensor is  $u$ .

The same result may be obtained as follows:—

$$\begin{aligned} \nabla\xi &= - \left( i \frac{d}{dx} + j \frac{d}{dy} + k \frac{d}{dz} \right) Si\sigma \\ &= - u (iS . iqiq^{-1} + jS . ijqj^{-1} + kS . ikkq^{-1}) \\ &= - u (iS . iq^{-1}iq + jS . jq^{-1}iq + kS . kq^{-1}iq) \\ &= uq^{-1}iq \dots\dots\dots(9). \end{aligned}$$

Hence we have

$$- d\xi = uS . q^{-1}iq d\rho,$$

of which the condition of integrability is

$$V . \nabla . uq^{-1}iq = 0.$$

Thus  $u$  and  $q$  must be determined so as to satisfy the equation

$$V \cdot \nabla \cdot uq^{-1}\alpha q = 0 \dots\dots\dots(10),$$

whatever constant vector be represented by  $\alpha$ .

We may state our present conclusions in the following simple form. In order that (1) may represent a triple series of orthogonal surfaces, it is necessary and sufficient that the constituents of  $\sigma$  satisfy three equations of the form (9); i.e., that when severally equated to constants, they represent three series of surfaces which together cut space into cubes.

8. As a verification of (9) we see that it and the similar expressions for  $\nabla\eta$  and  $\nabla\zeta$  give

$$\begin{aligned} -d\sigma &= u(iSq^{-1}iqd\rho + \dots\dots\dots) \\ &= -uqdpq^{-1}, \end{aligned}$$

which is equation (7).

9. Performing the operations indicated in (10), it becomes

$$V(\nabla u \cdot q^{-1}\alpha q) + uV \cdot \Sigma \left( iq^{-1}\alpha \frac{dq}{dx} - iq^{-1} \frac{dq}{dx} q^{-1}\alpha q \right) = 0,$$

or 
$$V \cdot \frac{\nabla u}{u} q^{-1}\alpha q + 2\Sigma V \cdot iV \cdot q^{-1}\alpha q q^{-1} \frac{dq}{dx} = 0,$$

(this simplification being permitted because (§ 6) the tensor of  $q$  may be regarded as unity) or, finally,

$$V \cdot \frac{\nabla u}{u} q^{-1}\alpha q - 2q^{-1}\alpha q \Sigma S \cdot iq^{-1} \frac{dq}{dx} + 2\Sigma \cdot (S \cdot q^{-1}\alpha qi) q^{-1} \frac{dq}{dx} = 0;$$

which may be written

$$V \cdot \frac{\nabla u}{u} q^{-1}\alpha q + 2q^{-1}\alpha q S(\nabla q^{-1} \cdot q) - 2\Sigma \cdot (S \cdot q^{-1}\alpha qi) \frac{dq^{-1}}{dx} q = 0,$$

or 
$$V \cdot \frac{\nabla u}{u} q^{-1}\alpha q + 2q^{-1}\alpha q S(\nabla q^{-1} \cdot q) - 2S \cdot (q^{-1}\alpha q \nabla) q^{-1} \cdot q = 0.$$

Here  $\alpha$  has the values  $i, j, k$ , so that if we write

$$q^{-1}\alpha q = i', \text{ \&c.},$$

we have three equations of the type

$$-V \cdot i' \frac{\nabla u}{u} + 2i'S(\nabla q^{-1} \cdot q) - 2S(i'\nabla)q^{-1} \cdot q = 0 \dots\dots\dots(11).$$

From these we have

$$-\Sigma \cdot i' V \cdot i' \frac{\nabla u}{u} - 6S \cdot \nabla q^{-1} q + 2\nabla q^{-1} \cdot q = 0,$$

or 
$$\frac{\nabla u}{u} - 3S(\nabla q^{-1} \cdot q) + \nabla q^{-1} \cdot q = 0.$$

Hence 
$$S(\nabla q^{-1} \cdot q) = 0$$
 and 
$$\frac{\nabla u}{u} = -V(\nabla q^{-1} \cdot q) = -\nabla q^{-1} \cdot q = -\frac{\nabla q^{-1}}{q^{-1}} \dots\dots\dots(12),$$

or, finally, 
$$\nabla \cdot uq^{-1} = 0 \dots\dots\dots(13).$$

10. But this is not the only relation between  $u$  and  $q$ . For by (12) we may write (11) in the form

$$-V(\nabla q^{-1} \cdot q q^{-1} \alpha q) q^{-1} - 2S \cdot (q^{-1} \alpha q \nabla) q^{-1} = 0 \dots\dots\dots(14).$$

It is obvious that, by adding the three equations of this form, each multiplied by a proper scalar, we may derive from them three equivalent ones of the form

$$V(\nabla q^{-1} \cdot qi) q^{-1} + 2S(i\nabla) q^{-1} = 0 \dots\dots\dots(15).$$

This may be written by the help of (12) in the form

$$2 \frac{dq^{-1}}{dx} q = -V \cdot i \nabla q^{-1} q = V \cdot i \frac{\nabla u}{u} = V \cdot i \nabla \log u \dots\dots\dots(16),$$

and we thus see that the constancy of the tensor of  $q$  is recognised.

Differentiating again after multiplying into  $q^{-1}$ , we have

$$\begin{aligned} 2 \frac{d^2 q^{-1}}{dx^2} &= V(i\nabla \log u) \frac{dq^{-1}}{dx} + V \cdot i \frac{d}{dx} \nabla \log u \cdot q^{-1} \\ &= \frac{1}{2} (V \cdot i \nabla \log u)^2 q^{-1} + V \cdot i \frac{d}{dx} \nabla \log u \cdot q^{-1}. \end{aligned}$$

Adding the three equations of this form, we have

$$-2\nabla^2 q^{-1} = (\nabla \log u)^2 q^{-1} \dots\dots\dots(17),$$

for obviously  $\nabla^2 \log u$  is a scalar.

But we have also 
$$\nabla \cdot uq^{-1} = 0 \dots\dots\dots(18),$$

which gives 
$$\nabla \log u \cdot q^{-1} + \nabla q^{-1} = 0$$

and 
$$\nabla^2 \log u \cdot q^{-1} + \Sigma \cdot i (\nabla \log u) \frac{dq^{-1}}{dx} + \nabla^2 q^{-1} = 0,$$

or 
$$\nabla^2 \log u \cdot q^{-1} + \frac{1}{2} \Sigma \cdot i (\nabla \log u) V(i\nabla \log u) q^{-1} + \nabla^2 q^{-1} = 0,$$

which may be simplified into

$$\nabla^2 \log u \cdot q^{-1} + (\nabla \log u)^2 q^{-1} + \nabla^2 q^{-1} = 0 \dots\dots\dots(19).$$

Together, (17) and (19) give

$$\left. \begin{aligned} \nabla^2 \log u \cdot q^{-1} - \nabla^2 q^{-1} &= 0 \\ \nabla^2 \log u + (\nabla \log u)^2 &= 0 \end{aligned} \right\} \dots\dots\dots(20)$$



The latter of these equations may be written

$$\nabla (u^{\frac{1}{2}} \nabla \log u) = 0 = \nabla \left( \frac{\nabla u}{u^{\frac{1}{2}}} \right),$$

or finally

$$\nabla^2 (u^{\frac{1}{2}}) = 0 \dots\dots\dots(21).$$

11. Hence  $u$  is the square of the potential of some distribution of matter, none of which is contained in the space occupied by the surfaces.

Hence the only strict solution, i.e., the only one that holds at every point of infinite space, is

$$u = \text{constant},$$

and, of course,

$$q = \text{constant}.$$

From this we have 
$$\begin{aligned} \nabla \xi &= uq^{-1}iq = u (ia_1 + jb_1 + kc_1) \\ \xi &= c_1 + u (a_1x + b_1y + c_1z). \end{aligned}$$

Thus the constituents of  $\sigma$ , separately equated to constants, give the equations of three series of mutually perpendicular planes cutting space into cubes, for  $u$  is the same for all. When we turn the axes so as to be perpendicular to these planes respectively, and adopt a suitable origin, we have

$$\xi = ux, \quad \eta = uy, \quad \zeta = uz,$$

whence

$$\sigma = u\rho,$$

and thus equation (1) gives in this case the confocal surfaces of the second order.

12. We omit for the present, in consequence of the remark at the beginning of last section, other obvious solutions of (21), such as

$$u^{\frac{1}{2}} = S_2\rho, \quad \text{or} \quad u^{\frac{1}{2}} = e^{S(\alpha + \sqrt{-1}\beta)\rho}, \quad \&c.$$

But if we admit that at *one* point of space there may be a particle of matter of mass  $m$ , we have, of course,

$$u = \frac{m^2}{T\rho^2},$$

so that

$$\nabla q^{-1} \cdot q = \frac{2\rho}{T\rho^2},$$

which gives as a particular integral  $q^{-1} = U\rho$ .

Hence, in this case,  $d\sigma = uq d\rho q^{-1} = -\frac{m^2}{T\rho^2} (2U\rho S U\rho d\rho + d\rho)$

$$= -\frac{m^2}{T\rho^4} (2\rho S\rho d\rho - d\rho\rho^2) = +m^2 \left( \frac{2\rho dT\rho}{T^2\rho^3} - \frac{d\rho}{T\rho^2} \right),$$

or

$$\sigma = m^2\rho^{-1}.$$

The corresponding surfaces are the electric images of the confocal quadrics, taken from the common centre, and include Fresnel's surface of elasticity.

13. It follows, from what we have just proved, that the only orthogonal surfaces which divide all space into indefinitely small cubes are planes and their electric images, or images of images, &c. These are all, therefore, included in a triple series of spheres having a common point, and their centres in three rectangular axes passing through that point.

In fact, if in (7) we put for  $\sigma$

$$\sigma' = (\sigma + \tau)^{-1},$$

we have

$$\frac{d\sigma'}{dx} = -\sigma' \frac{d\sigma}{dx} \sigma', \text{ \&c.,}$$

whence

$$S \frac{d\sigma'}{dx} \frac{d\sigma'}{dy} = \sigma'^4 S \frac{d\sigma}{dx} \frac{d\sigma}{dy} = 0, \text{ \&c.,}$$

and

$$T \frac{d\sigma'}{dx} = T \frac{d\sigma'}{dy} = T \frac{d\sigma'}{dz} = uT\sigma'^2.$$

Hence the electric image of any orthogonal system is also orthogonal; and, if the system cut space into cubes, so does the image.

14. We are now prepared to introduce the conditions that the surfaces (1) shall each be isothermal. If  $h, h_1, h_2$  represent their temperatures, these conditions are simply

$$\nabla^2 h = 0, \quad \nabla^2 h_1 = 0, \quad \nabla^2 h_2 = 0 \dots \dots \dots (22).$$

To express these in another form we must now differentiate equations (2).

15. By (2) we have

$$S\sigma\psi^{-2} \sigma \cdot f'(h) \frac{dh}{dx} = 2S \cdot \frac{d\sigma}{dx} \psi^{-1} \sigma.$$

This gives

$$2S \frac{d\sigma}{dx} \psi^{-2} \sigma \cdot f'(h) \frac{dh}{dx} - 2S \cdot \sigma \psi^{-3} \sigma \{f'(h)\}^2 \left(\frac{dh}{dx}\right)^2 + S\sigma\psi^{-2} \sigma \cdot f''(h) \left(\frac{dh}{dx}\right)^2 + S\sigma\psi^{-2} \sigma \cdot f'(h) \frac{d^2h}{dx^2} = 2S \cdot \frac{d^2\sigma}{dx^2} \psi^{-1} \sigma + 2S \cdot \frac{d\sigma}{dx} \psi^{-1} \frac{d\sigma}{dx} - 2S \frac{d\sigma}{dx} \psi^{-2} \sigma \cdot f'(h) \frac{dh}{dx}.$$

Eliminating  $\frac{dh}{dx}$  from these equations, we have

$$\frac{4S \cdot \frac{d\sigma}{dx} \psi^{-2} \sigma S \cdot \frac{d\sigma}{dx} \psi^{-1} \sigma}{S \cdot \sigma \psi^{-2} \sigma} - 8S \cdot \sigma \psi^{-3} \sigma \frac{S^2 \cdot \frac{d\sigma}{dx} \psi^{-1} \sigma}{S^2 \cdot \sigma \psi^{-2} \sigma} + 4S \cdot \sigma \psi^{-2} \sigma \frac{f''(h)}{[f'(h)]^2} \frac{S^2 \cdot \frac{d\sigma}{dx} \psi^{-1} \sigma}{S^2 \cdot \sigma \psi^{-2} \sigma} + S\sigma\psi^{-2} \sigma \cdot f'(h) \frac{d^2h}{dx^2} = 2S \cdot \frac{d^2\sigma}{dx^2} \psi^{-1} \sigma + 2S \cdot \frac{d\sigma}{dx} \psi^{-1} \frac{d\sigma}{dx} - 4S \cdot \frac{d\sigma}{dx} \psi^{-2} \sigma \frac{S \cdot \frac{d\sigma}{dx} \psi^{-1} \sigma}{S \cdot \sigma \psi^{-2} \sigma}.$$

Now, whatever vector  $\varpi$  may be, we have by §§ (5), (6)

$$-u^2 \varpi = \frac{d\sigma}{dx} S \cdot \frac{d\sigma}{dx} \varpi + \frac{d\sigma}{dy} S \cdot \frac{d\sigma}{dy} \varpi + \frac{d\sigma}{dz} S \cdot \frac{d\sigma}{dz} \varpi,$$

so that, if  $\omega$  be any other vector,

$$-u^2 S \cdot \omega \varpi = \Sigma S \cdot \frac{d\sigma}{dx} \omega S \cdot \frac{d\sigma}{dx} \varpi.$$

Adding, then, the three equations, of which that containing  $\frac{d^2h}{dx^2}$  is given above, we find

$$\begin{aligned} & -4u^2 \frac{S \cdot \psi^{-2} \sigma \psi^{-1} \sigma}{S \cdot \sigma \psi^{-2} \sigma} + 8u^2 S \cdot \sigma \psi^{-3} \sigma \frac{S \cdot \psi^{-1} \sigma \psi^{-1} \sigma}{S^2 \cdot \sigma \psi^{-2} \sigma} - 4u^2 \frac{f''(h)}{\{f'(h)\}^2} \frac{S \cdot \psi^{-1} \sigma \psi^{-1} \sigma}{S \cdot \sigma \psi^{-2} \sigma} \\ & = -2S \cdot \nabla^2 \sigma \psi^{-1} \sigma + 2\Sigma S \cdot \frac{d\sigma}{dx} \psi^{-1} \frac{d\sigma}{dx} + 4u^2 \frac{S \cdot \psi^{-2} \sigma \psi^{-1} \sigma}{S \cdot \sigma \psi^{-2} \sigma}, \end{aligned}$$

where the term in  $\nabla^3 h$  of course vanishes by (22). This is seen at a glance to be equivalent to

$$-4u^2 \frac{f''(h)}{\{f'(h)\}^2} = -2S \cdot \nabla^2 \sigma \psi^{-1} \sigma + 2\Sigma S \cdot \frac{d\sigma}{dx} \psi^{-1} \frac{d\sigma}{dx}.$$

The last term here is seen at once, by Hamilton's beautiful theory of linear and vector functions, to be equivalent to

$$2u^2 \Sigma S \cdot i \psi^{-1} i = -2u^2 \left( \frac{1}{A+f(h)} + \frac{1}{B+f(h)} + \frac{1}{C+f(h)} \right) \dots\dots\dots(23),$$

if  $A, B, C$  be the constants of  $\phi$ . Calling the expression in brackets for the present  $H$ , we have

$$-H + 2 \frac{f''(h)}{\{f'(h)\}^2} = \frac{1}{u^2} S \cdot \nabla^2 \sigma \psi^{-1} \sigma \dots\dots\dots(24).$$

The left-hand member, if multiplied by  $f'(h) dh$ , is the differential of a function of  $h$  only. If, as in § 11 we have

$$\sigma = u\rho, \quad u = \text{constant},$$

the right-hand side vanishes, and integration gives

$$C'h = \int \frac{f'(h) dh}{\sqrt{\{A+f(h)\} \{B+f(h)\} \{C+f(h)\}}} = \int \frac{df}{\sqrt{M_f}}.$$

If  $\sigma$  have the value given in § 12, equation (24) is obviously not satisfied. Thus confocal quadrics are the only isothermal orthogonal surfaces included in equation (1) with our present limitations.

16. It is interesting in itself, and will be useful for the second part of this paper, to eliminate  $\sigma$  from (24) by the help of our previous equations. For this purpose we may write (2) in the form

$$\begin{aligned} -T^2 \psi^{-1} \sigma f'(h) \nabla h &= 2\Sigma \left( iS \cdot \frac{d\sigma}{dx} \psi^{-1} \sigma \right) \\ &= 2u\Sigma (iS \cdot iq^{-1} \psi^{-1} \sigma q) \\ &= -2uq^{-1} \psi^{-1} \sigma q \dots\dots\dots(25), \end{aligned}$$

the tensor of which is  $T\psi^{-1}\sigma f'(h) T\nabla h = 2u$ .

But it is shown in (29) below that  $\nabla u = q^{-1}\nabla^2\sigma q$ ,

so that (25) gives  $T^2\psi^{-1}\sigma f'(h) S \cdot \nabla u \nabla h = 2uS \cdot \nabla^2\sigma \psi^{-1}\sigma$ ,

or, by (24), 
$$= 2u^3 \left( -H + 2 \frac{f''(h)}{\{f'(h)\}^2} \right) \dots\dots\dots(26).$$

The three equations of this form give

$$\Sigma \cdot T^2\psi^{-1}\sigma f'(h) \nabla h S \cdot \nabla h \nabla u = 2u^3 \Sigma \cdot \nabla h \left( -H + 2 \frac{f''(h)}{\{f'(h)\}^2} \right),$$

or, by (25) and (3),  $-4u^2\nabla u = 2u^3\Sigma \cdot f'(h) \nabla h \left( -H + 2 \frac{f''(h)}{\{f'(h)\}^2} \right).$

Operating by  $S \cdot d\rho$ , this gives

$$2 \frac{du}{u} = -\Sigma f'(h) dh \left( -H + 2 \frac{f''(h)}{\{f'(h)\}^2} \right),$$

of which the integral, by (23), is

$$C' - 2 \log u = \Sigma [2 \log f'(h) - \log \{A + f(h)\} \{B + f(h)\} \{C + f(h)\}],$$

or, if we write 
$$\frac{f'(h)}{\sqrt{\{A + f(h)\} \{B + f(h)\} \{C + f(h)\}}} = F(h) \dots\dots\dots(27),$$

then 
$$\frac{C''}{u} = F(h) F(h_1) F(h_2) \dots\dots\dots(28).$$

17. The following is the first quaternion method that occurred to me. I give it here, though it is considerably more prolix than the preceding, because it exhibits, incidentally, many curious properties of the system  $\sigma, u, q$  above defined.

Starting again with equation (7), we see that it gives

$$-\nabla^2\sigma = q\nabla u q^{-1} - 2uq\Sigma \left( V \cdot iVq^{-1} \frac{dq}{dx} \right) q^{-1}.$$

This, as we shall see immediately, may be reduced to

$$-q\nabla u q^{-1} \dots\dots\dots(29).$$

18. From (7) we obtain at once

$$\begin{aligned} \frac{1}{u} \frac{d^2\sigma}{dx dy} &= \frac{dq}{dy} iq^{-1} - qi q^{-1} \frac{dq}{dy} q^{-1} + \frac{1}{u^2} \frac{du}{dy} \frac{d\sigma}{dx}, \\ &= \frac{dq}{dy} iq^{-1} - qi q^{-1} \frac{dq}{dy} q^{-1} + \frac{1}{u} qi q^{-1} \frac{du}{dy}, \\ \frac{1}{u} \frac{d^2\sigma}{dy dx} &= \frac{dq}{dx} jq^{-1} - qj q^{-1} \frac{dq}{dx} q^{-1} + \frac{1}{u} qj q^{-1} \frac{du}{dx}. \end{aligned}$$

Comparing the last two values, we have

$$\frac{1}{u} q^{-1} \frac{d^2\sigma}{dx dy} q = -2V \cdot i V q^{-1} \frac{dq}{dy} + \frac{i}{u} \frac{du}{dy} = -2V \cdot j V q^{-1} \frac{dq}{dx} + \frac{j}{u} \frac{du}{dx} \dots\dots\dots(30).$$

Operating by  $S \cdot k$ , we have  $-S \cdot j q^{-1} \frac{dq}{dy} = S \cdot i q^{-1} \frac{dq}{dx}$ .

From this, and other equations similar to it, it is obvious that

$$S \cdot i q^{-1} \frac{dq}{dx} = S \cdot j q^{-1} \frac{dq}{dy} = S \cdot k q^{-1} \frac{dq}{dz} = 0 \dots\dots\dots(31).$$

For we should find, as their common value, the expression of their *sum*

$$S \cdot i q^{-1} \frac{dq}{dx} + S \cdot j q^{-1} \frac{dq}{dy} + S \cdot k q^{-1} \frac{dq}{dz}.$$

19. Also, from (30) and the other similar equations, we have the following series of values—

$$\left. \begin{aligned} \frac{1}{u} \frac{du}{dy} &= 2S \cdot k q^{-1} \frac{dq}{dx} \\ \frac{1}{u} \frac{du}{dz} &= 2S \cdot i q^{-1} \frac{dq}{dy} \\ \frac{1}{u} \frac{du}{dx} &= 2S \cdot j q^{-1} \frac{dq}{dz} \\ -\frac{1}{u} \frac{du}{dx} &= 2S \cdot k q^{-1} \frac{dq}{dy} \\ -\frac{1}{u} \frac{du}{dy} &= 2S \cdot i q^{-1} \frac{dq}{dz} \\ -\frac{1}{u} \frac{du}{dz} &= 2S \cdot j q^{-1} \frac{dq}{dx} \end{aligned} \right\} \dots\dots\dots(32).$$

These give three equations of the form

$$V \cdot q^{-1} \frac{dq}{dx} = \frac{1}{2u} \left( j \frac{du}{dz} - k \frac{du}{dy} \right),$$

which enable us at once to make the transformation assumed in § 17 above, and may be all summed up in the following—in which the omission of the  $V$  is due to the remark in § 6 that the tensor of  $q$  may be assumed constant—

$$2V \cdot q^{-1} dq = 2q^{-1} dq = -V \cdot (d\rho \nabla) \log u \dots\dots\dots(33).$$

This is the equation determining the quaternion which gives the position of a rigid body in terms of the vector-axis of instantaneous rotation. (“On the Rotation of a Rigid Body about a Fixed Point,” No. XV. above.)

20. But by § 6, we have

$$\left. \begin{aligned} \left(\frac{d\sigma}{dx}\right)^2 &= \left(\frac{d\sigma}{dy}\right)^2 = \left(\frac{d\sigma}{dz}\right)^2 = -u^2, \\ S \frac{d\sigma}{dx} \frac{d\sigma}{dy} &= S \frac{d\sigma}{dy} \frac{d\sigma}{dz} = S \frac{d\sigma}{dz} \frac{d\sigma}{dx} = 0 \end{aligned} \right\} \dots\dots\dots(34).$$

From these

$$\begin{aligned} S \frac{d\sigma}{dx} \frac{d^2\sigma}{dx^2} &= -u \frac{du}{dx}, \\ S \frac{d\sigma}{dy} \frac{d^2\sigma}{dx^2} &= -S \frac{d\sigma}{dx} \frac{d^2\sigma}{dx dy} = u \frac{du}{dy}, \\ S \frac{d\sigma}{dz} \frac{d^2\sigma}{dx^2} &= -S \frac{d\sigma}{dx} \frac{d^2\sigma}{dx dz} = u \frac{du}{dz}, \end{aligned}$$

which give

$$\begin{aligned} -u^2 \frac{d^2\sigma}{dx^2} &= u \left( -\frac{du}{dx} \frac{d\sigma}{dx} + \frac{du}{dy} \frac{d\sigma}{dy} + \frac{du}{dz} \frac{d\sigma}{dz} \right) \\ &= -2u \frac{du}{dx} \frac{d\sigma}{dx} + u \left( \frac{du}{dx} \frac{d\sigma}{dx} + \frac{du}{dy} \frac{d\sigma}{dy} + \frac{du}{dz} \frac{d\sigma}{dz} \right). \end{aligned}$$

From the three equations of this form we obtain, first,

$$u^2 \nabla^2 \sigma = u \left( \frac{du}{dx} \frac{d\sigma}{dx} + \frac{du}{dy} \frac{d\sigma}{dy} + \frac{du}{dz} \frac{d\sigma}{dz} \right) \dots\dots\dots(35);$$

and, secondly, three equations of the form

$$\frac{d}{dx} \left( \frac{1}{u^2} \frac{d\sigma}{dx} \right) = -\frac{1}{u^3} \left( \frac{du}{dx} \frac{d\sigma}{dx} + \frac{du}{dy} \frac{d\sigma}{dy} + \frac{du}{dz} \frac{d\sigma}{dz} \right).$$

These are summed up in

$$\frac{d}{dx} \left( \frac{1}{u^2} \frac{d\sigma}{dx} \right) = \frac{d}{dy} \left( \frac{1}{u^2} \frac{d\sigma}{dy} \right) = \frac{d}{dz} \left( \frac{1}{u^2} \frac{d\sigma}{dz} \right) = -\frac{1}{u^2} \nabla^2 \sigma \dots\dots\dots(36),$$

which express some of the conditions of *orthogonality* of the three series of surfaces given by equation (1).

21. To obtain the others, remark that by (30) we have

$$\frac{1}{u} q^{-1} \frac{d^2\sigma}{dx dy} q = -2V \cdot iVq^{-1} \frac{dq}{dy} + \frac{i}{u} \frac{du}{dy} = -2V \cdot jVq^{-1} \frac{dq}{dx} + \frac{j}{u} \frac{du}{dx},$$

or 
$$\frac{1}{u} q^{-1} \frac{d^2\sigma}{dx dy} q = V \cdot iVj\nabla \cdot \log u + \frac{i}{u} \frac{du}{dy} = V \cdot jVi\nabla \cdot \log u + \frac{j}{u} \frac{du}{dx},$$

and that each of the two latter expressions may be written

$$\frac{i}{u} \frac{du}{dy} + \frac{j}{u} \frac{du}{dx}.$$

Hence

$$\frac{d^2\sigma}{dx dy} = \frac{1}{u} \left( \frac{d\sigma}{dx} \frac{du}{dy} + \frac{d\sigma}{dy} \frac{du}{dx} \right) \dots\dots\dots(37),$$

and there are, of course, other two vector equations of a similar form.

From these we have nine scalar equations of the form

$$\frac{d^2\xi}{dxdy} = \frac{1}{u} \left( \frac{d\xi}{dx} \frac{du}{dy} + \frac{d\xi}{dy} \frac{du}{dx} \right) \dots\dots\dots(38).$$

Now

$$\begin{aligned} \frac{d}{dy} \left( \frac{1}{u^2} \frac{d\xi}{dx} \right) &= \left( \frac{1}{u^2} \frac{d^2\xi}{dxdy} - \frac{2}{u^3} \frac{du}{dy} \frac{d\xi}{dx} \right) \\ &= \frac{1}{u^3} \left( \frac{d\xi}{dy} \frac{du}{dx} - \frac{d\xi}{dx} \frac{du}{dy} \right). \end{aligned}$$

Symmetry shows from this that

$$\frac{d}{dy} \left( \frac{1}{u^2} \frac{d\xi}{dx} \right) = - \frac{d}{dx} \left( \frac{1}{u^2} \frac{d\xi}{dy} \right) \dots\dots\dots(39),$$

which is one of another set of nine equations, three each for  $\xi, \eta, \zeta$ .

22. Now, by (36), it is obvious that we may write,  $\varpi_1$  being a new variable,

$$\frac{1}{u^2} \frac{d\xi}{dx} = \frac{d^2\varpi_1}{dydz}, \quad \frac{1}{u^2} \frac{d\xi}{dy} = \frac{d^2\varpi_1}{dzdx}, \quad \frac{1}{u^2} \frac{d\xi}{dz} = \frac{d^2\varpi_1}{dxdy} \dots\dots\dots(40),$$

and thus (39) becomes

$$\frac{d^3\varpi_1}{dy^2dz} = - \frac{d^3\varpi_1}{dx^2dz} \dots\dots\dots(41),$$

with two others in  $\varpi_1$  and three each in  $\varpi_2, \varpi_3$ .

Putting

$$\omega_1 = \frac{d^3\varpi_1}{dxdydz},$$

these give by differentiation

$$\begin{aligned} \frac{d^2\omega_1}{dy^2} &= - \frac{d^2\omega_1}{dx^2} \\ \frac{d^2\omega_1}{dz^2} &= - \frac{d^2\omega_1}{dy^2} \\ \frac{d^2\omega_1}{dx^2} &= - \frac{d^2\omega_1}{dz^2}, \end{aligned}$$

so that all three quantities vanish. Hence we have

$$\omega_1 = \frac{d^3\varpi_1}{dxdydz} = 2hxyz + 2lyz + 2mzx + 2nxy + 2ax + 2by + 2cz + e,$$

where  $h, l, m, n, a, b, c, e$  are absolutely constant. From this, and (40), we have

$$\left. \begin{aligned} \frac{1}{u^2} \frac{d\xi}{dx} &= hxy^2z + 2lxyz + mx^2 + nx^2y + ax^2 + 2bxy + 2cxa + ex + f_1(y, z), \\ \frac{1}{u^2} \frac{d\xi}{dy} &= hxy^2z + ly^2z + 2mxyz + nxy^2 + 2axy + by^2 + 2cyz + ey + f_2(z, x), \\ \frac{1}{u^2} \frac{d\xi}{dz} &= hxy^2z + lyz^2 + mz^2x + 2nxyz + 2azx + 2byz + cz^2 + ez + f_3(x, y), \end{aligned} \right\} \dots\dots(42).$$

Applying (39) to these, we obtain

$$\left. \begin{aligned} hx^2z + 2lxz + nx^2 + 2bx + \frac{df_1}{dy} &= -hy^2z - 2myz - ny^2 - 2ay - \frac{df_2}{dx} \\ hxy^2 + 2mxy + ly^2 + 2cy + \frac{df_2}{dz} &= -hxz^2 - lz^2 - 2nzx - 2bz - \frac{df_3}{dy} \\ hyz^2 + 2nyz + mz^2 + 2az + \frac{df_3}{dx} &= -hx^2y - 2lxy - mx^2 - 2cx - \frac{df_1}{dz} \end{aligned} \right\} \dots\dots\dots(43).$$

The elimination of  $f_2$  from the two first, by differentiation, gives

$$h(x^2 - y^2) + 2lx - 2my + \frac{d^2f_1}{dydz} = \frac{d^2f_3}{dxdy} + h(z^2 - y^2) - 2my + 2nz,$$

and the third gives

$$hz^2 + 2nz + \frac{d^2f_3}{dxdy} = -\frac{d^2f_1}{dydz} - hx^2 - 2lx,$$

so that we have

$$hx^2 + 2lx + \frac{d^2f_1}{dydz} = hy^2 + 2my + \frac{d^2f_2}{dzdx} = hz^2 + 2nz + \frac{d^2f_3}{dxdy} = 0 \dots\dots\dots(44),$$

which proves that  $h, l, m, n$  are separately zero, and that each of the  $f$ 's is the sum of two separate functions, each containing one of the constituent variables only, *i.e.*,

$$\left. \begin{aligned} f_1(y, z) &= Y_1 + Z_1 \\ f_2(z, x) &= Z_2 + X_2 \\ f_3(x, y) &= X_3 + Y_3 \end{aligned} \right\} \dots\dots\dots(45).$$

But by (43) and (45), we have

$$2bx + \frac{dY_1}{dy} = -2ay - \frac{dX_2}{dx}, \text{ \&c.,}$$

whence

$$\frac{dY_1}{dy} = -p''' - 2ay$$

$$\frac{dX_2}{dx} = p''' - 2bx, \text{ \&c.,}$$

giving

$$Y_1 = -ay^2 + C - p'''y$$

$$X_2 = -bx^2 + C' + p'''x, \text{ \&c.,}$$

so that, finally,

$$\left. \begin{aligned} \frac{1}{u^2} \frac{d\xi}{dx} &= a(x^2 - y^2 - z^2) + 2bxy + 2czx + ex + g_1 - p'''y + p''z \\ \frac{1}{u^2} \frac{d\xi}{dy} &= 2axy + b(y^2 - x^2 - z^2) + 2cyz + ey + g_2 - p'z + p'''x \\ \frac{1}{u^2} \frac{d\xi}{dz} &= 2azx + 2byz + c(z^2 - x^2 - y^2) + ez + g_3 - p''x + p'y \end{aligned} \right\} \dots\dots\dots(46).$$



If, in these, we write

$$\begin{aligned} ia + jb + kc &= \gamma \\ ig_1 + jg_2 + kg_3 &= \gamma_1 \\ ip' + jp'' + kp''' &= \gamma_2, \end{aligned}$$

we obtain, by multiplication by  $i, j, k$  respectively and addition,

$$\frac{1}{w^2} \nabla \xi = e\rho - \rho\gamma\rho + \gamma_1 + V\gamma_2\rho \dots\dots\dots(46'),$$

which is equivalent to the three equations (46), and may be put in the form

$$\frac{1}{w^2} \nabla \xi = (e - 2S\gamma\rho) \rho + \gamma\rho^2 + \gamma_1 + V\gamma_2\rho \dots\dots\dots(46'').$$

23. It was shown above, § 7, that

$$\nabla \xi, \nabla \eta, \nabla \zeta$$

form a rectangular system of vectors whose common tensor is  $u$ . Hence, by (46'') we have three equations of the form

$$\begin{aligned} -\frac{1}{u^2} &= (e - 2S\gamma\rho)^2 \rho^2 + \gamma^2 \rho^4 + \gamma_1^2 + S^2 \gamma_2 \rho - \rho^2 \gamma_2^2 \\ &+ 2\rho^2 S\gamma\rho (e - 2S\gamma\rho) + 2S\gamma_1 \rho (e - 2S\gamma\rho) + 2\rho^2 S\gamma\gamma_1 + 2\rho^2 S \cdot \gamma\gamma_2 \rho + 2S \cdot \gamma_1 \gamma_2 \rho, \end{aligned}$$

expressing the equality of the tensors; and three others of the form

$$\begin{aligned} 0 &= (e - 2S\gamma\rho) (e' - 2S\gamma'\rho) \rho^2 + \rho^2 (e' - 2S\gamma'\rho) S\gamma\rho + (e' - 2S\gamma'\rho) S\gamma_1 \rho \\ &+ (e - 2S\gamma\rho) \rho^2 S\gamma'\rho + \rho^4 S\gamma\gamma' + \rho^2 S\gamma'\gamma_1 + \rho^2 S \cdot \gamma'\gamma_2 \rho \\ &+ (e - 2S\gamma\rho) S\gamma_1'\rho + \rho^2 S\gamma_1'\gamma + S\gamma_1'\gamma_1 + S \cdot \gamma_1'\gamma_2 \rho \\ &+ \rho^2 S \cdot \gamma\gamma_2'\rho + S \cdot \gamma_1\gamma_2'\rho + S\gamma_2'\rho S\gamma_2 \rho - S\gamma_2'\gamma_2 \rho^2. \end{aligned}$$

Here the constants in  $\nabla \eta, \nabla \zeta$ , are expressed by the application of one, and two, dashes respectively to those of  $\nabla \xi$ .

In the first set of three, the terms in the various powers of  $T\rho$  must be equal. This gives the following sets

$$\begin{aligned} \gamma^2 &= \gamma'^2 = \gamma''^2 \\ S(V\gamma\gamma_2 - e\gamma) \rho &= S(V\gamma'\gamma_2' - e'\gamma') \rho = \dots\dots \\ (e^2 - \gamma_2^2 + 2S\gamma\gamma_1) \rho^2 + S^2 \gamma_2 \rho - 4S\gamma\rho S\gamma_1 \rho &= \dots\dots \\ S(V\gamma_1\gamma_2 + e\gamma_1) \rho &= \dots\dots\dots = \dots\dots \\ \gamma_1^2 &= \gamma_1'^2 = \gamma_1''^2. \end{aligned}$$

In the other set of three, we have by the same process

$$\begin{aligned}
 0 &= S\gamma\gamma' = S\gamma'\gamma'' = S\gamma''\gamma \\
 0 &= S\rho \{V\gamma'\gamma_2 + V\gamma\gamma_2' - e'\gamma - e\gamma'\} = \dots\dots \\
 0 &= \rho^2 \{ee' + S\gamma'\gamma_1 + S\gamma_1'\gamma - S\gamma_2\gamma_2'\} - 2S\gamma'\rho S\gamma_1\rho - 2S\gamma\rho S\gamma_1'\rho + S\gamma_2\rho S\gamma_2'\rho = \dots\dots \\
 0 &= S\rho \{V\gamma_1'\gamma_2 + V\gamma_1\gamma_2' + e'\gamma_1 + e\gamma_1'\} = \dots\dots\dots = \dots\dots \\
 0 &= S\gamma_1\gamma_1' = S\gamma_1'\gamma_1'' = S\gamma_1''\gamma_1.
 \end{aligned}$$

We might easily have obtained this last set of equations from that which preceded, by a species of differentiation,  $\rho$  being constant, and  $d\gamma = \gamma'$ ,  $d\gamma' = \gamma''$ , &c.

24. From these we conclude that, if they exist at all,  $\gamma$ ,  $\gamma'$ ,  $\gamma''$ , and  $\gamma_1$ ,  $\gamma_1'$ ,  $\gamma_1''$ , form rectangular systems with equal tensors. In terms of them we obtain

$$\begin{aligned}
 -\gamma_2 &= \kappa\gamma_1 - e'\gamma_1' + e'\gamma_1'' = c\gamma + e'\gamma' - e\gamma'' \\
 -\gamma_2' &= e'\gamma_1 + \kappa\gamma_1' - e\gamma_1'' = -e'\gamma + c\gamma' + e\gamma'' \\
 -\gamma_2'' &= -e'\gamma_1 + e\gamma_1' + \kappa\gamma_1'' = e'\gamma - e\gamma' + c\gamma'',
 \end{aligned}$$

where  $\kappa$  and  $c$  are scalar constants to be determined.

Expressing, from these,  $\gamma_1$  in terms of  $\gamma$ ,  $\gamma'$ ,  $\gamma''$ , we have

$$\gamma_1 = -\gamma + \frac{c + \kappa}{D} \{(\kappa^2 + e^2)\gamma + (ee' + \kappa e'')\gamma' + (ee'' - \kappa e)\gamma''\},$$

where

$$D = \begin{vmatrix} \kappa, & -e', & e' \\ e', & \kappa, & -e \\ -e', & e, & \kappa \end{vmatrix} = \kappa \{\kappa^2 + e^2 + e'^2 + e''^2\}.$$

Now, the above expressions for  $\gamma_2$ , &c., show that

$$T\gamma_1 = T\gamma, \text{ \&c.,}$$

hence by expanding and simplifying

$$0 = \frac{c + \kappa}{D} (\kappa^2 + e^2) \left(2 - \frac{c + \kappa}{\kappa}\right).$$

This admits of no values but  $\kappa = \mp c$ ,

and  $\kappa = e = e' = e'' = 0$ .

The first of these three values of  $\kappa$  gives

$$\gamma_1 = -\gamma, \text{ \&c.,}$$

and thence, by the equations at the end of § 23, leads to an impossibility, which requires that all three sets of vectors  $\gamma$ ,  $\gamma_1$ ,  $\gamma_2$  shall be null, and thus gives no solution. A similar nugatory result is obtained from the second.

The third thus shows that the only solution is

$$\frac{1}{u^2} \nabla \xi = \gamma_1, \text{ \&c.}$$

Hence

$$\nabla \frac{1}{u^2} = 0,$$

and, finally,

$$\sigma = -u^2 (iS\gamma_1\rho + jS\gamma_1'\rho + kS\gamma_1''\rho),$$

where  $\gamma_1, \gamma_1', \gamma_1''$  form a rectangular system with equal tensors, whose common value must obviously be the reciprocal of  $u$ . But we have seen that

$$\frac{d\sigma}{dx}, \frac{d\sigma}{dy}, \frac{d\sigma}{dz},$$

also form a rectangular set of vectors with equal tensors. Hence

$$(Si\gamma_1)^2 + (Si\gamma_1')^2 + (Si\gamma_1'')^2 = (Sj\gamma_1)^2 + (Sj\gamma_1')^2 + (Sj\gamma_1'')^2 = \dots\dots$$

$$0 = Si\gamma_1 Sj\gamma_1 + Si\gamma_1' Sj\gamma_1' + Si\gamma_1'' Sj\gamma_1'', \text{ \&c.}$$

These equations also are satisfied identically, and we therefore have, as before,

$$\sigma = uq\rho q^{-1}$$

where  $u$  and  $q$  are each constant.

## XXVI.

## NOTE ON THE STRAIN-FUNCTION.

[*Proceedings of the Royal Society of Edinburgh, March 4, 1872.*]

WHEN the linear and vector function expressing a strain is self-conjugate the strain is pure. When it is not self-conjugate, it may be broken up into pure and rotational parts in various ways (analogous to the separation of a quaternion into the *sum* of a scalar and a vector part, or into the *product* of a tensor and a versor part), of which two are particularly noticeable. Denoting by a bar a self-conjugate function, we have thus either

$$\begin{aligned}\phi &= \bar{\psi} + V \cdot \epsilon ( \quad ), \\ \phi &= q \bar{\omega} ( \quad ) q^{-1}, \text{ or } \phi = \bar{\omega} \cdot q ( \quad ) q^{-1},\end{aligned}$$

where  $\epsilon$  is a vector, and  $q$  a quaternion (which may obviously be regarded as a mere versor).

That this is possible is seen from the fact that  $\phi$  involves nine independent constants, while  $\bar{\psi}$  and  $\bar{\omega}$  each involve six, and  $\epsilon$  and  $q$  each three. If  $\phi'$  be the function conjugate to  $\phi$ , we have

$$\phi' = \bar{\psi} - V \cdot \epsilon ( \quad )$$

so that

$$2\bar{\psi} = \phi + \phi'$$

and

$$2V \cdot \epsilon ( \quad ) = \phi - \phi'$$

which completely determine the first decomposition. This is, of course, perfectly well known in quaternions, but it does not seem to have been noticed as a theorem in the kinematics of strains that there is always one, and but one, mode of resolving

a strain into the geometrical composition of the separate effects of (1) a *pure* strain, and (2) a rotation accompanied by uniform dilatation perpendicular to its axis, the dilatation being measured by  $(\sec \theta - 1)$  where  $\theta$  is the angle of rotation.

In the second form (whose solution does not appear to have been attempted) we have

$$\phi = q\bar{\omega} ( ) q^{-1},$$

where the pure strain precedes the rotation; and from this

$$\phi' = \bar{\omega} \cdot q^{-1} ( ) q,$$

or in the conjugate strain the rotation (reversed) is followed by the pure strain. From these

$$\begin{aligned} \phi'\phi &= \bar{\omega} \cdot q^{-1} (q\bar{\omega} ( ) q^{-1}) q \\ &= \bar{\omega}^2, \end{aligned}$$

and  $\bar{\omega}$  is therefore to be found by the solution of a biquadratic equation, as in foot-note to XXI. § 6, above. It is evident, indeed, from the identical equation

$$S \cdot \sigma\phi'\phi\rho = S \cdot \rho\phi'\phi\sigma$$

that the operator  $\phi'\phi$  is self-conjugate.

In the same way

$$\phi\phi' ( ) = q\bar{\omega}^2 (q^{-1} ( ) q) q^{-1}$$

$$\text{or } q^{-1} (\phi\phi'\rho) q = \bar{\omega}^2 (q^{-1}\rho q) = \phi'\phi (q^{-1}\rho q)$$

which show the relations between  $\phi\phi'$ ,  $\phi'\phi$ , and  $q$ .

To determine  $q$  we have

$$\phi\rho \cdot q = q\bar{\omega}\rho$$

whatever be  $\rho$ , so that

$$S \cdot Vq (\phi - \bar{\omega}) \rho = 0,$$

$$\text{or } S \cdot \rho (\phi' - \bar{\omega}) Vq = 0,$$

$$\text{which gives } (\phi' - \bar{\omega}) Vq = 0.$$

The first of these three equations gives evidently

$$Vq \parallel V \cdot (\phi - \bar{\omega}) \alpha (\phi - \bar{\omega}) \beta$$

whatever be  $\alpha$  and  $\beta$ ; and the rest of the solution follows at once. A similar process gives us the solution when the rotation precedes the pure strain.

[*Addition*, read March 17, 1873.]

The author gave an account of the mode in which he had treated the Strain-Function in an elementary Treatise on Quaternions, soon to be published, mainly from the pen of Professor Kelland.

The coefficients of the cubic in  $\phi$  are determined easily from the condition that homogeneous strain alters the volume of every part of a body in the same ratio.

A careful examination is bestowed upon the case of three real roots of the cubic; especially with regard to the distinction between the results of a self-conjugate strain and a rotational one.

The separation of the pure and rotational parts of a strain is very fully treated; and as special examples, the strain of a rigid body and a simple shear are analysed.

Finally, the following problems are solved:—

*Find the conditions which must be satisfied by the simple shear, which is capable of reducing a given strain to a pure strain.*

*Find the relation between two linear and vector functions whose successive application produces rotation merely.*

All this is independent of the differential calculus, but as the following results regarding the stress-function require its aid, they cannot be introduced into the work referred to. They will appear, with extensions, in the second edition (now printing) of the author's Treatise on *Quaternions*.

At any point of a strained body, let  $\lambda$  be the vector stress per unit of area perpendicular to  $i$ ;  $\mu$ , and  $\nu$ , the same for planes perpendicular to  $j$  and  $k$  respectively.

Then, by considering an indefinitely small tetrahedron, we have for the stress per unit of area perpendicular to a unit vector  $\omega$ , the expression

$$\lambda Si\omega + \mu Sj\omega + \nu Sk\omega = -\phi\omega,$$

so that the stress across any plane is represented by a *linear and vector function* of the unit normal to the plane.

But if we consider the equilibrium, as regards rotation, of an infinitely small rectangular parallelepiped whose edges are parallel to  $i$ ,  $j$ ,  $k$ , respectively, we have (supposing that there are no molecular couples)

$$V(i\lambda + j\mu + k\nu) = 0,$$

or  $\Sigma V_i \phi_i = 0,$

or  $V \cdot \nabla \phi \rho = 0.$

This shows that  $\phi$  is *self-conjugate*, or, in other words, involves not nine distinct constants but only six.

Consider next the equilibrium, as regards translation, of any portion of the solid filling a simply-connected closed space. Let  $u$  be the potential of the external forces. Then the condition is obviously

$$\iint \phi (U\nu) ds + \iiint ds \nabla u = 0,$$

where  $\nu$  is the normal vector of the element of surface  $ds$ .

Here the double integral extends over the whole boundary of the closed space, and the triple integral throughout the whole interior.

To reduce this to a form to which the method of my paper "On Green's and other Allied Theorems" (No. XIX. above) is directly applicable, operate by  $S \cdot \alpha$  where  $\alpha$  is any constant vector whatever, and we have

$$\iint S \cdot \phi \alpha U \nu ds + \iiint ds S \alpha \nabla u = 0,$$

by taking advantage of the self-conjugateness of  $\phi$ . This may be written

$$\iiint ds (S \cdot \nabla \phi \alpha + S \cdot \alpha \nabla u) = 0,$$

and, as the limits of integration may be any whatever,

$$S \cdot \nabla \phi \alpha + S \cdot \alpha \nabla u = 0 \dots \dots \dots (1).$$

This is the required equation, the indeterminateness of  $\alpha$  rendering it equivalent to *three* scalar conditions.

As a verification, it may be well to show that from this equation we can get the condition of equilibrium, as regards *rotation*, of a simply-connected portion of the body, which can be written by inspection, as

$$\iint V \cdot \rho \phi (U\nu) ds + \iiint V \cdot \rho \nabla u ds = 0.$$

This is easily done as follows:—(1) gives

$$S \cdot \nabla \phi \sigma + S \cdot \sigma \nabla u = 0,$$

if, and only if,  $\sigma$  satisfy the condition,

$$S \cdot \phi (\nabla) \sigma = 0.$$

Now this condition is satisfied if

$$\sigma = V \alpha \rho,$$

where  $\alpha$  is any constant vector. For

$$\begin{aligned} S \cdot \phi(\nabla) V\alpha\rho &= -S \cdot \alpha V\phi(\nabla)\rho \\ &= S \cdot \alpha V\nabla\phi\rho = 0. \end{aligned}$$

Hence

$$\iiint d\varsigma (S \cdot \nabla\phi V\alpha\rho + S \cdot \alpha\rho\nabla u) = 0,$$

or

$$\iiint d\varsigma S \cdot \alpha\rho\phi U\nu + \iiint d\varsigma S \cdot \alpha\rho\nabla u = 0.$$

Multiplying by  $\alpha$ , and adding the results obtained by making  $\alpha$  in succession each of three rectangular unit vectors, we obtain the required equation.

Suppose  $\sigma$  to be the displacement of a point originally at  $\rho$ , then the work done by the stress on any simply-connected portion of the solid is obviously

$$W = \iint S \cdot \phi(U\nu) \sigma ds,$$

because  $\phi(U\nu)$  is the vector force overcome on the element  $ds$ .

This is easily transformed to

$$W = \iiint S \cdot \nabla\phi\sigma d\varsigma.$$



## XXVII.

## ON A QUESTION OF ARRANGEMENT AND PROBABILITIES.

[*Proceedings of the Royal Society of Edinburgh, January 6, 1873.*]

MANY of the common illustrations of probabilities are taken from games in which each hand, or trick, *must* necessarily be won by one player, and lost by the other. It becomes an interesting question to inquire what modification is introduced if we contemplate the possibility of a hand, or trick, being drawn—*i.e.* not won or lost by either player. The only difficulty lies in taking account of the limiting conditions.

In the game of golf, for instance, where each hole separately may be won, halved, or lost, we have the following question. When a player is  $x$  holes "up," and  $y$  "to play," in how many ways may he win?

Let this number be represented by  $P_{x,y}$ . Then obviously

$$P_{x+1,y+1} = P_{x+2,y} + P_{x+1,y} + P_{x,y}.$$

If

$$P_{x,y} = a^x b^y$$

be a particular integral, we have

$$ab = a^2 + a + 1,$$

so that

$$P_{x,y} = \Sigma C a^x \left( a + 1 + \frac{1}{a} \right)^y.$$

Now the conditions are obviously

$$P_{x,y} = 1, \text{ if } x > y;$$

and

$$P_{-x,y} = 0, \text{ if } x \geq y.$$

Failing in several attempts to determine fully the special form of  $P_{x,y}$  from these conditions, I had recourse to a graphical method, which will be given below. But before I do so, I take another mode of integration, which leads easily to special numerical results.

Suppose  $y = x + n$ ,

then the equation becomes  $\Delta P_{x, x+n} = P_{x+2, x+n} + P_{x+1, x+n}$

from which it appears that if we can find expressions for  $P_{x, x+n}$  and  $P_{x+1, x+n}$  we can deduce by summation that for  $P_{x-1, x+n}$ .

Let us first put  $n = 0$ ; we have

$$\Delta P_{x, x} = P_{x+2, x} + P_{x+1, x} = 2,$$

since, obviously, each of these quantities is unity. Integrating, we have

$$P_{x, x} = 2x,$$

no constant being added, since it is clear that

$$P_{0, 0} = 0.$$

Again, by the fundamental equation, putting  $n = 1$ , we have

$$\begin{aligned} \Delta P_{x, x+1} &= P_{x+2, x+1} + P_{x+1, x+1} \\ &= 1 + 2(x+1) \\ P_{x, x+1} &= x + x(x+1) + C \\ &= (x+1)^2 = x(x+1) + (x+1) \end{aligned}$$

for we have obviously

$$P_{0, 1} = 1.$$

Next,

$$\begin{aligned} \Delta P_{x, x+2} &= P_{x+2, x+2} + P_{x+1, x+2} \\ &= 2(x+2) + (x+2) + (x+1)(x+2), \\ P_{x, x+2} &= \frac{3}{2}(x+1)(x+2) + \frac{1}{3}x(x+1)(x+2), \end{aligned}$$

no constant being added, for

$$P_{0, 2} = 3.$$

Similarly,

$$P_{x, x+3} = \frac{5}{6}(x+1)(x+2)(x+3) + \frac{1}{2}(x+2)(x+3) + \frac{1}{12}x(x+1)(x+2)(x+3),$$

for

$$P_{0, 3} = P_{1, 2} + P_{0, 2} + P_{-1, 2} = 4 + 3 + 1 = 8.$$

$$P_{x, x+4} = \frac{2}{3}(x+2)(x+3)(x+4) + \frac{7}{24}(x+1)(x+2)(x+3)(x+4) + \frac{1}{60}x(x+1)(x+2)(x+3)(x+4)$$

for

$$P_{0, 4} = P_{1, 3} + P_{0, 3} + P_{-1, 3} = 11 + 8 + 4 = 23.$$

We may now, in conformity with these expressions, assume

$$P_{x, x+n} = \left\{ A_n + \frac{B_n}{x} + \frac{C_n}{x(x+1)} + \dots \right\} x \overline{x+1} \dots \overline{x+n}.$$

Now, if  $y = x + n$ , the original equation of differences gives

$$\Delta P_{x, x+n} = P_{x+2, x+n} + P_{x+1, x+n}$$

where  $\Delta$  refers to  $x$  and *not* to  $n$ . By the assumed value of  $P_{x, x+n}$  this becomes

$$\begin{aligned} & \left[ \frac{(n+1)A_n}{x} + \frac{nB_n}{x(x+1)} + \frac{(n-1)C_n}{x(x+1)(x+2)} + \dots \right] x \overline{x+1} \dots \overline{x+n} \\ &= \left[ A_{n-2} + \frac{B_{n-2}}{x+2} + \frac{C_{n-2}}{(x+2)(x+3)} + \dots \right] \overline{x+2} \dots \overline{x+n} \\ &+ \left[ A_{n-1} + \frac{B_{n-1}}{x+1} + \frac{C_{n-1}}{(x+1)(x+2)} + \dots \right] \overline{x+1} \dots \overline{x+n}, \end{aligned}$$

whence, equating coefficients of like factorials, we have

$$\begin{aligned} (n+1)A_n &= A_{n-1}, \\ nB_n &= B_{n-1} + A_{n-2}, \\ (n-1)C_n &= C_{n-1} + B_{n-2}, \\ (n-2)D_n &= D_{n-1} + C_{n-2}, \text{ \&c., \&c.} \end{aligned}$$

Let  $(n+1)!A_n = \alpha_n, \quad n!B_n = \beta_n, \quad (n-1)!C_n = \gamma_n, \quad \&c..$

then these equations become

$$\begin{array}{l|l} \alpha_n = \alpha_{n-1} & \alpha_n = \Sigma 0. \\ \beta_{n+1} = \beta_n + \alpha_{n-1} & \beta_n = \Sigma \alpha_{n-1} = \frac{\Sigma}{D} \alpha_n \\ \gamma_{n+1} = \gamma_n + \beta_{n-1} & \text{or } \gamma_n = \Sigma \beta_{n-1} = \frac{\Sigma}{D} \beta_n \\ \delta_{n+1} = \delta_n + \gamma_{n-1} & \delta_n = \Sigma \gamma_{n-1} = \frac{\Sigma}{D} \gamma_n, \text{ \&c.} \end{array}$$

Thus we have

$$\begin{aligned} P_{x, x+n} &= \left\{ \frac{\alpha_n}{(n+1)!} + \frac{1}{x \cdot n!} \frac{\Sigma}{D} \alpha_n + \frac{1}{x(x+1) \cdot (n-1)!} \left( \frac{\Sigma}{D} \right)^2 \alpha_n + \dots \right\} x(x+1) \dots (x+n) \\ &= \left\{ \alpha_n + \frac{n+1}{x} \frac{\Sigma}{D} \alpha_n + \frac{(n+1)n}{x(x+1)} \left( \frac{\Sigma}{D} \right)^2 \alpha_n + \dots \right\} \frac{x(x+1) \dots (x+n)}{1 \cdot 2 \dots (n+1)} \end{aligned}$$

T.

$$\begin{aligned}
&= \frac{1}{\left(\frac{\Sigma}{D}\right)^{x-1}} \left\{ \frac{\overline{x+n} \dots \overline{n+2}}{1 \cdot 2 \dots n-1} \left(\frac{\Sigma}{D}\right)^{x-1} + \frac{\overline{x+n} \dots \overline{n+1}}{1 \cdot 2 \dots n} \left(\frac{\Sigma}{D}\right)^x + \dots \right\} \alpha_n \\
&= \frac{\left(1 + \frac{\Sigma}{D}\right)^{x+n}}{\left(\frac{\Sigma}{D}\right)^{x-1}} \alpha_n,
\end{aligned}$$

for no negative powers of  $\frac{\Sigma}{D}$  are to be retained, as  $\alpha_n$  is a mere constant.

The trouble of carrying out this process is considerable, depending on the determination of the constants in each finite integral so as to satisfy the limiting conditions of the problem. To a few terms we have

$$P_{x, x+n} = \frac{(x+n)!}{(x-1)!(n+1)!} \left\{ 2 + (2n-1) \frac{n+1}{x} + (n-2)^2 \frac{(n+1)n}{x(x+1)} + \dots \right\}.$$

By a slight modification of the preceding process we get in succession

$$\Delta P_{-x, x+n} = P_{-(x+1), x+n} + P_{-(x+2), x+n},$$

$$P_{-x, x+n} = \frac{\left(1 + \frac{\Sigma}{D}\right)^{x+n}}{\left(\frac{\Sigma}{D}\right)^{x+1}} \alpha_n = \frac{(x+n)!}{(x+1)!(n-1)!} \left\{ 1 + (n-1) \frac{n-1}{x+2} + \frac{(n-4)(x-1)(n-2)(x-1)}{2(x+2)(x+3)} + \dots \right\}.$$

The graphical method to which I referred above consists simply in supposing the various values of  $P_{x, y}$  to be written each at the point whose co-ordinates are the values of  $x$  and  $y$ . If, to fix the ideas, we suppose the axis of  $x$  to be horizontal and that of  $y$  vertically downwards, then the fundamental equation shows that *by adding together any three contiguous numbers in a horizontal line, we produce the number immediately under the middle one of the three.*

The limiting conditions show that all the numbers along the line

$$x + y = 0,$$

and those between it and the negative part of the axis of  $x$ , are zeros; while those along

$$y = x - 1, \quad y = x - 2, \quad y + x = 1,$$

are each equal to 1.

Hence we have the figure

0	0	0	0	0	0	1	1	0	0	0	0	...	<i>x</i>	
0	0	0	0	0	1	2	1	1	0	0	0			
0	0	0	0	1	3	4	4	1	1	0	0	.....	(a)	
0	0	0	1	4	8	11	9	6	1	1	0			
0	0	1	5	13	23	28	26	16	8	1	1			
0	1	6	19	41	64	77	70	50	25	10	1			
				⋮										
&c.				<i>y</i>										&c.

where the numbers printed in darker type are inserted by the rule given above. This is, of course, in one sense a complete solution of the problem; but the results may easily be put in an analytical form.

Had we had zeros along the line

$$y = x - 2$$

we should have had the following scheme instead of that above:

			0	1	0			...	<i>x</i>				
		0	1	1	1	0							
	0	1	2	3	2	1	0	.....	(b)				
	0	1	3	6	7	6	3	1	0				
	0	1	4	10	16	19	16	10	4	1	0		
				⋮									
	&c.			<i>y</i>									&c.

Hence the part added by the units along the line

$$y = x - 2$$

is

				0				...	<i>x</i>	
			0	1						
		0	1	1	2					
	0	1	2	4	3	3	.....	(c)		
	0	1	3	7	9	10	6	4		
				⋮						
				<i>y</i>						&c.

This, again, differs from (b) shifted one place downwards, by

$$\begin{array}{cccccccc}
 & & & & & & & \dots & x \\
 & & & & & & & & & \\
 & & & & & & & & & 0 & 0 \\
 & & & & & & & & & 0 & 0 & 1 \\
 & & & & & & & & & 0 & 1 & 1 & 2 & \dots\dots\dots(d). \\
 & & & & & & & & & 1 & 2 & 4 & 3 & 3 \\
 & & & & & & & & & \vdots \\
 & & & & & & & & & y & \&c.
 \end{array}$$

But it is obvious that this is a repetition of the same one place diagonally downwards to the right.

Also (b) is obviously the coefficients of the powers of  $a$  in

$$a \left( a + 1 + \frac{1}{a} \right)^y$$

for the several positive integral values of  $y$ . Call the term in  $a^x$  in this, i.e. the coefficient of  $a^{x-1}$  in  $\left( a + 1 + \frac{1}{a} \right)^y$ ,  $A_{x, y}$ , and that at  $x, y$  in the scheme (c)  $Q_{x, y}$ , then

$$Q_{x, y} - Q_{x-1, y-1} = A_{x, y-1},$$

and thus

$$\begin{aligned}
 P_{x, y} &= A_{x, y} + Q_{x, y} \\
 &= A_{x, y} + A_{x, y-1} + A_{x-1, y-2} + \dots
 \end{aligned}$$

This points to a very simple way of constructing the values of  $P_{x, y}$  from those of  $A_{x, y}$ .

In scheme (b), add to the number in any position that immediately above it, and also those lying in the left-handed upward diagonal drawn from the last named, their sum is the number in the corresponding position in (a). Thus  $16 + 6 + 3 + 1 = 26$ .

If  $D$  refer to  $x$  and  $D'$  to  $y$ , we have

$$\begin{aligned}
 P_{x, y} &= \left( 1 + \frac{1}{D'} + \frac{1}{DD'^2} + \frac{1}{D^2D'^3} + \dots \right) A_{x, y}, \\
 &= \left( 1 + \frac{D}{DD' - 1} \right) A_{x, y}.
 \end{aligned}$$

It is to be observed that, since if one player wins the other must lose,  $P_{-x, y}$  is the number of ways in which a player may lose, when he is  $x$  "up" and  $y$  "to play."

The number of ways in which the game may be drawn is also a solution of the same equation of differences; but the limiting conditions are now obviously independent of the sign of  $x$ : and are, taking it positive,

$$\begin{aligned}
 P_{x, y} &= 1 \text{ if } x = y, \\
 P_{x, y} &= 0 \text{ if } x > y.
 \end{aligned}$$

Hence the values are represented by the following scheme—

$$\begin{array}{cccccccc}
 & & 0 & 1 & 0 & & & \dots x \\
 & & & 0 & 1 & 1 & 1 & 0 \\
 & & & & 0 & 1 & 2 & 3 & 2 & 1 & 0 \\
 & & & & & 0 & 1 & 3 & 6 & 7 & 6 & 3 & 1 & 0 \\
 & & & & & & & & \vdots & & & & & \\
 & & & & & & & \&c. & y & \&c.
 \end{array}$$

Thus the value of  $P_{x,y}$  in this case is the coefficient of  $a^x$  in

$$\left(a + 1 + \frac{1}{a}\right)^y.$$

Hence the number of different modes in which the game may finish, when one of the players is  $x$  "up" and there remain  $y$  "to play" is, calling  $R_{x,y}$  the coefficient of  $a^x$  in  $\left(a + 1 + \frac{1}{a}\right)^y$ ,

$$\left[ \left(D + \frac{1}{D}\right) \left(1 + \frac{D}{DD' - 1}\right) + 1 \right] R_{x,y},$$

while the number of different ways of finishing if the whole  $y$  holes are played out is  $3^y$ .

There are very many curious properties of the numbers we have denoted by  $P_{x,y}, A_{x,y}, Q_{x,y}$ . Thus, for instance, it is easy to see that

$$\begin{array}{ccc}
 Q_{1,2} = Q_{2,2} - 1, & Q_{0,2} = Q_{2,2} + 1, & \&c., \\
 Q_{1,3} = Q_{3,3} + 1, & Q_{0,3} = Q_{3,3} - 1,
 \end{array}$$

all of which are included in

$$Q_{x,y} = Q_{3-x,y} + (-1)^{x+y}.$$

## XXVIII.

## THERMO-ELECTRICITY\*.

[*Nature*, Vol. VIII.]

THE subject I have chosen is one intimately connected with the names of at least two well-known members of this University—the late Prof. Cumming and Sir William Thomson. It possesses at present peculiar interest for the physicist; for, though a great many general facts and laws connected with it are already experimentally, or otherwise, secured to science—the pioneers have done little more than map the rough outlines of some of the more prominent features of a comparatively new and almost unexplored region. Some of its experimental problems are extremely simple, others seem at present to present all but insuperable difficulties. And it does not appear that any further application of mathematical analysis can be safely, or at least usefully, made until some doubtful points are cleared up experimentally.

The grand idea of the conservation, or indestructibility, of energy:—pointed out by Newton in a short Scholium a couple of centuries ago, so far at least as the progress of experimental science in his time enabled him to extend his statements:—conclusively established for heat at the very end of last century by Rumford and Davy; and extended to all other forms of energy by the splendid researches of Joule:—forms the groundwork of modern physics.

Just as, in the eye of the chemist, every chemical change is merely a rearrangement of indestructible and unalterable matter; so to the physicist, every physical change is merely a transformation of indestructible energy; and thus the whole aim of natural philosophy, so far at least as we yet know, may be described as the study of the possible transformations of energy, with their conditions and limitations; and of the present forms and distribution of energy in the universe, with their past and future.

\* Abstract of the Rede Lecture delivered in the Senate House, Cambridge, May 23, 1873.



It is found by experiment that some forms of energy are more easily or more completely transformable than others, and thus we speak of higher and lower forms, and are introduced to the enormously important consideration of the degradation, or, as it is more commonly called, the dissipation, of energy. The application of mathematical reasoning to the conservation of energy presented no special difficulties which had not, to some extent at least, been overcome in Newton's time: but it was altogether otherwise with the transformations of energy. And it is possible that, had it not been for the wonderfully original processes devised by Carnot in 1824, we might not now have secured more than a small fraction of the immense advances which science has taken during the last thirty years.

For a transformation of heat we must have bodies of different temperatures. Just as water has no "head" unless raised above the sea-level, so heat cannot do work except with the accompaniment of a transference from a hotter to a colder body. Carnot showed that to reason on this subject we must have *cycles* of operations, at the end of which the working substance is restored exactly to its initial state. And he also showed that the test of a *perfect* engine (*i.e.* the best which is, even theoretically, attainable) is simply that it must be *reversible*. By this term we do not mean mere backing, as in the popular use of the word, but something much higher—*viz.* that, whereas, when working directly, the engine does work during the letting down of heat from a hot to a cold body; when reversed, it shall spend the same amount of work while pumping up the same quantity of heat from the cold body to the hot one. As a reversible engine may be constructed (theoretically at least) with any working substance whatever, and as all reversible engines working under similar circumstances must be equivalent to one another (since each is as good as an engine can be) it is clear that the amount of work derivable from a given amount of heat under given circumstances (*i.e.* the amount of transformation possible) can depend only upon the temperatures of the hot and cold bodies employed. In this sense we speak of Carnot's Function of Temperature, which is as imperishably connected with his name as is the Dynamical Equivalent of Heat with that of Joule.

Building upon this work of Carnot, Sir W. Thomson gave the first *absolute* definition of temperature—that is a definition independent of the properties of any particular substance. Perhaps there is no term in the whole range of science whose meaning is correctly known to so few even of scientific men, as this common word temperature. It would not, I think, be an exaggeration to say that there are not six books yet published in which it is given with even an approach to accuracy. The form in which the definition ultimately came from the hands of Joule and Thomson enables us to state as follows the laws of transformation of energy from the heat form.

1. A given quantity of heat has a definite transformation equivalent.
2. But only a fraction of this heat can be transformed by means even of a perfect engine: and this fraction is DEFINED as the ratio of the range through which

the heat actually falls to that through which it might fall—were it possible to obtain and employ bodies absolutely deprived of heat.

This definition has two great advantages. 1st, The utmost amount of work to be got from heat under any circumstances of temperature is determined by precisely the same law as that assigning the work to be had from water under similar circumstances of level. In this case the sea-level corresponds to what is called the Absolute Zero of temperature. [It is well to observe here that it is the potential energy of the water, not the quantity of water itself, which corresponds in this analogy to the quantity of heat. In this simple remark we have all that is necessary to correct Carnot's reasoning in so far as it was rendered erroneous by his assumption of the materiality (and consequent indestructibility) of heat.] 2nd, Temperatures thus defined correspond, as Thomson and Joule have shown by elaborate experiments, very closely indeed with those given by the air-thermometer—the absolute zero being about  $274^{\circ}$  of the Centigrade scale below the freezing point of water. I have made this digression as I shall have frequently to use the word temperature, and I shall always employ it in the sense just explained [except when I use a qualifying C. 1897].

The subject of Thermo-electricity of course includes all electric effects depending on heat, but in this lecture I shall confine myself to the production by heat of currents in a circuit of two metals.

The transformation of heat into the energy of current electricity was first observed by Seebeck in 1820 or 1821. His paper on the subject (*Berlin Ac.*, 1822–3, or *Pogg.* VI.) is particularly interesting, as he gives the whole history of his attempts to obtain a voltaic current from a circuit of two metals without a liquid, and the steps by which he was led to see that heat was the active agent in producing the currents he eventually obtained. In this paper Seebeck gave the relative order of a great number of metals and alloys in the so-called thermo-electric series, and showed that several *changes of order* occurred among them as the temperature was gradually raised.

In a note attached to this paper, Seebeck recognises that in this further discovery he was anticipated by Cumming (who seems, in fact, to have made an independent discovery of Thermo-electricity). Cumming showed that when wires of copper, gold, &c., were gradually heated with iron, the deflection rose to a maximum, then fell off, and was *reversed* at a red heat.

[Seebeck's original experiment and Cumming's extension of it were exhibited.]

You see that, keeping one of the copper-iron junctions at the temperature of the room and gradually heating the other, I produce a current which increases in intensity more and more slowly till it reaches a maximum, then falls off faster and faster till at last it vanishes and thereafter sets in the *opposite* direction. We are still far below the melting point of copper, yet further heating up to that point produces but little additional effect. The reason of this will be apparent from some facts to be described towards the end of the lecture. At the moment of maximum

current the two metals are thermo-electrically *Neutral* to one another.—The temperature in the present case is about 280° C.

Seebeck pointed out that bismuth and antimony (to the choice of which he had been led by a very curious set of arguments) were very far removed from one another in the series, and therefore gave large effects for small differences of temperature. This is still taken advantage of in the Thermo-electric Pile, which, when combined with a sufficiently delicate galvanometer, is even now by far the most delicate thermometer we possess. It has recently enabled astronomers to detect and measure the heat which reaches us from the moon, and even from the brighter fixed stars. In the skilful hands of Forbes and Melloni this instrument was the effective agent in demonstrating the identity of thermal and luminous radiations—a step which, as regards the simplification of science, is as important as the discovery of magneto-electricity; a step which was completed by Forbes when he succeeded in polarising radiant heat.

But when we come to look at this question from the point of view of transformation of energy, we have to ask *where* is the absorption, and *where* the letting-down of heat, to which the development of the current considered as a rise of energy is due. Very remarkably, an experiment of Peltier supplies us with at least part of the answer. Peltier showed that, given a metallic junction which when heated would give a current in a certain direction, then provided a battery were interposed in that circuit (initially at a uniform temperature) so as to send a current in that direction, the passage of the current *cooled* the junction, while a reversal of the current heated it. This, considering the circumstances under which it was made, and the deductions since drawn from it, is one of the most extraordinary experimental discoveries ever made. Water was frozen, in an experiment by Lenz, by means of the Peltier effect.

Here then is a reversible heat effect, and to it we may reasonably assume that the laws of thermodynamics may be applied; although from the very nature of the experiment the reversible effect must always be accompanied by non-reversible ones, such as dissipation by heat-conduction, and by heat generated in consequence of the resistance of the circuit. The latter of these is in general small in thermo-electric researches, but the former may have large values.

It is known from the beautiful experiments of Magnus that no thermo-electric current can be produced by unequal heating in a homogeneous circuit, whatever be the variations of section—a negative result of the highest importance. Sir W. Thomson, to whom we are indebted for the first and the most complete application of thermodynamics to our subject, showed that the existence of a neutral point necessitates the existence of some other reversible effect besides that of Peltier. And even if the circuit varied in section, the result of Magnus, just referred to, showed that this could only be of the nature of a convection of heat by the current between portions of the same metal at different temperatures. Thomson's reasoning is of the very simplest character, as follows:—Suppose the temperature of the hotter junction

to be that of the neutral point, there is no absorption or evolution of heat there; yet there is evolution of heat at the colder junction, and (by resistance) throughout the whole circuit. The energy which supplies this must be that of the heat in one or both of the separate metals; but reasoning of this kind, though it proves that there must be such an effect, leaves to be decided by direct experiment what is the nature and amount of this effect in each of the metals separately. By an elaborate series of ingenious experiments Thomson directly proved the existence of a current convection of heat, and (curiously enough) of opposite signs in the first two metals (iron and copper) which he examined. In his own words, "Vitreous Electricity carries heat with it in an unequally heated copper conductor, and Resinous Electricity carries heat with it in an unequally heated iron conductor." This statement is not very easy to follow. It may perhaps be more intelligible in the form:—In copper a current of positive electricity tends to equalise the temperature of the point it is passing at any instant with that of the point of the conductor which it has just left, *i.e.*, when it passes from cold to hot it tends to cool the whole conductor; when from hot to cold, to heat it; thus behaving like a real liquid in an irregularly heated tube. The effects in iron are the opposite; and Thomson therefore speaks of the specific heat of electricity as being thus positive in copper and negative in iron. He gives a very remarkable analogy from the motion of water in an endless tube (with horizontal and vertical branches), produced by differences of density, due to differences of temperature. Here the maximum density of water plays a prominent part. Neumann has recently attempted, by means of the laws of motion of fluids, and the unequal expansibility of different metals, to give a physical explanation of thermo-electric currents. But, not to speak of the fact that positive electricity is by him considered as a real fluid, there are the fatal objections that his method makes no provision for the explanation of the Peltier, or of the Thomson, effect; and therefore cannot be looked upon as having any useful relation to the subject. Similar remarks apply to the attempt of Avenarius to account for thermo-electric currents by the variation with temperature of the electrostatic difference of potentials at the points of contact of different metals.

By employing the thermo-electric pile instead of the thermometers used by Thomson, Le Roux has lately measured the amount of the specific heat of electricity in various metals, and has shown that it is very small, or altogether absent, in lead. Strangely enough, though he has verified Thomson's results, he does not wholly accept the theoretical reasoning which led to their prediction and discovery.

One of Thomson's happiest suggestions connected with this subject is the construction of what he calls a thermo-electric diagram. In its earliest form this consisted merely of parallel columns, each containing the names of a number of metals arranged in their proper thermo-electric order for some particular temperature. Lines drawn connecting the positions of the name of any one metal in these successive columns indicate how it changes its place among the other metals as the temperature is raised. Thomson points out clearly what should be aimed at in perfecting the diagram, but he left it merely as a preliminary sketch. The importance of the idea,

however, is very great; for, as we shall see, the diagram when carefully constructed gives us not merely the relative positions of the metals at various temperatures, with the temperatures of their neutral points, but also gives graphic representations of the specific heat of electricity in each metal in terms of the temperature, the amount of the Peltier effect, and the electromotive force (and its direction) for a circuit of any two metals with given temperatures of the junctions. In short, the study of the whole subject may be reduced to the careful drawing by experiment of the thermo-electric diagram, and the verification of Thomson's thermodynamic theory will then be effected by a direct determination either of Peltier effects or of specific heat of electricity at various temperatures, and their comparison with the corresponding indications of the diagram.

The diagram is constructed so that abscissæ represent absolute temperatures, and the difference of the ordinates of the lines for any two metals at a given temperature is the electromotive force of a circuit of these metals, one of the junctions being half a degree above, the other half a degree below, the given temperature.

It will be seen by what follows that nothing but direct measurement of the value of the specific heat of electricity at various temperatures can give us the actual form of the line representing any particular metal; but if the line for any one metal be assumed, those of all others follow from it by the process of differences of ordinates just described. So that it is well to begin by assuming the axis of abscissæ as the line for a particular metal (say lead, in consequence of Le Roux's result); and if, at any future time, this should be found to require change, a complex shearing motion of the diagram parallel to the axis of ordinates will put all the lines simultaneously into their proper form.

Thomson's theoretical investigation may be put in a very simple form as follows:— Let us suppose an arrangement of two metallic wires, one end of each of which is heated, their cold ends being united, and in which the circuit can be closed by a sliding piece or ring, always so placed as to join points of the two metals which are at the same temperature  $t$ . Let  $E$  be the electromotive force in the circuit,  $\Pi$  the Peltier effect, and  $\sigma_1, \sigma_2$  the specific heats of electricity in the two metals. Then, if the sliding piece be moved from points at temperature  $t$  to others at  $t + \delta t$ , the first law of thermodynamics gives by inspection the equation

$$\delta E = J (\delta \Pi + \overline{\sigma_1 - \sigma_2} \delta t),$$

and the second law gives

$$0 = \delta \left( \frac{\Pi}{t} \right) + \frac{\sigma_1 - \sigma_2}{t} \delta t.$$

These equations show at once that, if there were no electric convection of heat, or if it were of equal amount in the two metals, the Peltier effect would always be proportional to the absolute temperature; and the electromotive force would be proportional to the difference of temperatures of the junctions; so that there could not be a neutral point in any case. In fact, the lines in the diagram for all metals

would be parallel: and, on the former of the two hypotheses, parallel to the axis of abscissæ.

Eliminating  $\sigma_1 - \sigma_2$  between the equations, we have

$$\delta E = J \frac{\Pi}{t} \delta t.$$

Now, by the construction of the diagram,  $\frac{dE}{dt}$  is the difference of the ordinates of the lines for the two metals at temperature  $t$ . Hence, *whatever be the form of the lines for two metals*, the Peltier effect at a junction at temperature  $t$  is always proportional to the area of the rectangle whose base is the difference of the ordinates, and whose opposite side is part of the axis of ordinates corresponding to absolute zero of temperature. This area becomes less and less as we approach the neutral point, and changes sign (*i.e., is turned over*) after we pass it; the current being supposed to go from the same one of the two metals to the other in each case.

The electromotive force itself, being the integral of  $\frac{dE}{dt}$  between the limits of temperature, is proportional to the area intercepted between the lines of the two metals, and ordinates drawn to correspond to the temperatures of the junctions respectively.

Again, the second of the preceding equations shows us that the difference of specific heats in the two metals is proportional to the absolute temperature and to the difference of the tangents of the inclinations of the lines for the metals to the axis of abscissæ. If we assume this axis to be the line of a metal in which the electric convection of heat is wholly absent, the measure of this convection in any other metal is simply the product of the absolute temperature into the tangent of inclination of its line to the axis. Thus, if the thermo-electric line for a metal be straight, electric convection is in it always proportional to the absolute temperature; and it is positive or negative according as the line goes off to infinity in the first or in the fourth quadrant. If the lines for any two metals be straight, and if one junction be kept at a constant temperature, the electromotive force will be a parabolic function of the temperature of the other junction—the vertex of the parabola being at the temperature of the neutral point of the two metals, and its axis being parallel to the axis of ordinates.

For the benefit of such of my audience as are not familiar with mathematical terms, I may give an illustration which is numerically exact. Let time stand for temperature, years corresponding say to degrees. Let the ordinate of one of the metals represent a man's income, that of the other his expenditure. The difference of these ordinates represents the rate of increase of his capital or accumulated savings, which here stands for electromotive force. As long as income exceeds expenditure, the capital increases; when income and expenditure are equal (*i.e.*) at a "neutral

point," capital remains stationary, indicating, in this case, a maximum value; for in succeeding years expenditure exceeds income, and capital is drawn upon.

Guided by considerations of Dissipation of Energy\*, I was led some years ago to the hypothesis that specific heat of electricity must be, like thermal and electric resistance, directly proportional to the absolute temperature. If this were the case, the lines in the diagram would be straight for all metals; and parabolas would be the graphic representation not only of electromotive force, but of the Peltier effect, in terms of the temperature of a junction. And I found by actual measurement of curves plotted from experiment, that, within the range of mercury thermometers, the curves of electromotive force for junctions of any two of iron, cadmium, zinc, copper, silver, gold, lead, and some other metals, are parabolas with their axes vertical; the differences from parabolas being in no case greater than the inevitable errors of experiment and the deviation of mercury thermometers from absolute temperature. If, then, the line for any one of these metals be straight within these limits of temperature, so are those of all the others. This makes the tracing of the diagram within these limits a very simple matter indeed. And an easy verification is furnished by the fact that from the parabolas for metals *A* and *B*, and *A* and *C*, we can draw the lines for *B* and *C*, assuming any line for *A*; and we can then compare the temperature of the intersection of these lines with that of the neutral point of *B* and *C* as found directly. Another verification is supplied by the tangents of the angles at which these parabolas cut the axis of abscissæ, for the sum of two of them ought in every case to be equal to the third.

In fact, if we assume, in accordance with what has been said above,

$$J\sigma_1 = k_1 t, \quad J\sigma_2 = k_2 t,$$

where  $k_1$  and  $k_2$  are constants, Thomson's formulæ give at once

$$J \frac{\Pi}{t} = - \int (k_1 - k_2) dt, \quad \text{or} \quad J\Pi = (k_1 - k_2)(T_{1,2} - t)t$$

where  $T_{1,2}$  (the constant of integration) is obviously the temperature of the neutral point.

Also

$$E = J \int \frac{\Pi}{t} dt = (k_1 - k_2) \int (T_{1,2} - t) dt$$

$$= (k_1 - k_2)(t - t_0) \left( T_{1,2} - \frac{t + t_0}{2} \right)$$

where  $t_0$  is the temperature of the cold junction. This is the parabolic formula already mentioned.

Comparing with the parabola as given by observation we get the values of  $k_1 - k_2$  and  $T_{1,2}$ . Similarly we obtain  $k_1 - k_3$  and  $T_{1,3}$ . Hence we may calculate

\* [The only *simple* way in which the conditions of No. XIV., above, can be realized (while the current raises or lowers the temperature all along the wire) is by making the changes directly proportional to the (absolute) temperatures themselves. 1897.]

$k_2 - k_3$ , and (by the second equation above) the value of  $T_{2,3}$  from the relation

$$(k_1 - k_2) T_{1,2} + (k_2 - k_3) T_{2,3} + (k_3 - k_1) T_{1,3} = 0.$$

Thus we have the means of verification above alluded to—for the equation just written expresses the relation among the tangents of the angles at which the three parabolas cut the axis of abscissæ.

[It is to be remarked that if the circuit consist of one and the same metal, we have

$$k_1 = k_2, T = \infty, (k_1 - k_2) T = \tau \text{ suppose,}$$

whence

$$J\Pi = \tau t,$$

which shows that the electric convection of heat may be regarded as an infinitesimal case of Peltier effect between adjacent portions of the same metal at infinitesimally different temperatures.

Also, on the same hypothesis, we have

$$E = \tau (t - t_0)$$

which seems to accord with the result of some experiments made for me by Mr Durham [*Proc. R.S.E.*, vii. 788], in which the deflection due to the contact of the hot and cold ends of the same wire was shown to be proportional to the difference of temperatures and independent of the actual temperature of either.]

Endeavouring to extend the investigation to temperatures beyond the reach of mercury thermometers, I worked for a long time with a small air-thermometer, of which the principle was suggested to me by Dr Joule. But this involved very great experimental difficulties, due mainly to chemical action at high temperatures; and, after much unsatisfactory work, I resolved to make one thermo-electric junction play the part of thermometer in observing the indications of another. In fact, an exceedingly elegant result follows at once from the preceding formulæ, if we suppose the specific heat of electricity to be proportional to the absolute temperature in each of four metals, and then draw a curve whose ordinate and abscissa are the simultaneous galvanometric indications of pairs of these metals, with their hot and cold junctions respectively at the same temperatures. For if  $\tau$  be the difference of absolute temperature of the junctions, we have

$$x = A\tau + B\tau^2$$

$$y = C\tau + D\tau^2$$

where the four constants depend upon the nature of the metals and upon the absolute temperature of the cold junction. These equations give

$$(Dx - By)^2 = (CB - AD)(Cx - Ay)$$

which is the equation of another parabola, also passing through the origin, but with its axis no longer vertical.



A simple proof of this theorem is furnished by the motion of projectiles in vacuo. Suppose a particle to move under gravity, and subject, besides, to another constant force parallel to a given horizontal line—its path would have both ordinate and abscissa parabolic functions of the time. But its path might also be found by compounding into one the two accelerations, and as each of these is constant in direction and magnitude, their resultant will have the same property, and thus the resultant path is a parabola. Tried in this way through ranges of temperature up to a red heat, I found that while some pairs of circuits gave excellent parabolas, others were far from doing so, sometimes in fact giving curves with points of contrary flexure. I was on the point of recurring to the air-thermometer, when I noticed that in nearly every case in which the curve was not a parabola, iron was one of the metals employed; and, by the help of some alloys of platinum, I was enabled to get an idea of the true cause of the anomaly, and afterwards to verify it by an independent method. The cause is this, that while, as Thomson discovered, the specific heat of electricity in iron is *negative* at ordinary temperatures, it becomes *positive* at some temperature near low red heat; and remains positive till near the melting point of iron, where it appears possible, from some of my experiments, that it may again change sign. Thus the line for iron, straight at ordinary temperatures, passes downwards from the first quadrant to the fourth, and thence rises into the first again.

To recur to our analogy, an income represented by the iron line is one which for a number of years steadily diminishes, reaches a minimum, and then steadily increases. If this be associated with a steady expenditure, the fluctuations of capital will depend upon the comparative values of the expenditure and the minimum income. If the expenditure be less than the minimum income, the capital will go on increasing slower and slower to a certain point, then faster and faster; there will be no stationary point, but there will be a point of contrary flexure. If the expenditure be just equal to the minimum income, the point of contrary flexure will be also a stationary point. If the expenditure be greater than the minimum income there will be a maximum of capital, then a point of contrary flexure, and then a minimum; the maximum and minimum being the stationary points corresponding to the two occasions on which the expenditure equals the income. The maximum and minimum will obviously be farther apart, and smaller, the larger is the expenditure compared with the minimum income.

The latter part of these statements is well exhibited by the behaviour of circuits of iron, and various alloys of platinum with Iridium, Nickel, and Copper.

[Some of these, involving two, and in one case three, neutral points, were shown.]

In each of these cases there are obviously two neutral points, at least. Now suppose the two junctions raised to the temperatures of these two neutral points respectively, and we have a thermo-electric current maintained *entirely* by the specific heat of electricity, as there is obviously neither absorption nor evolution of heat at either junction. Still further, suppose (as is *very nearly* the case with one of the alloys I have just used) that the specific heat of electricity is *null* in the metal associated with iron, and we have the very remarkable fact of a *current maintained*

*in a circuit, without absorption or evolution of heat at either junction or in one of the metals, but with evolution of heat in one part of the second metal and absorption in another part.* This suggests immediately the idea that iron becomes, as it were, a different metal on being raised above a certain temperature. This may possibly have some connection with the Ferricum and Ferrosium of the chemists; with the change of magnetic properties of iron, and of its electric resistance, at high temperatures. Dr Russell has kindly enabled me to verify these properties in a specimen of pure iron prepared by Matthiessen. I find similar effects with Nickel at a much lower temperature. The method of control which I employed to satisfy myself that these peculiarities are due to iron and not to the platinum alloys, requires a little explanation. It depends upon the fact that by the help of two metals made into a double arc (wires of the two being stretched side by side, without contact except at the ends) we can explore any portion of the field between the lines for these two metals by simply altering the ratio of the resistances in the two parts of the double arc. Such a complex arrangement gives a line passing through the intersection of the lines of the two constituents, and depending for its position on their relative resistances. I shall not, at this stage of my lecture, trouble you with the formula which gives the line for the double arc in terms of the resistances of the two metals and their lines, but simply show the experiments with the help of a gold and a palladium wire, the one having the specific heat of electricity positive, the other negative; while their neutral point is considerably below the temperature of the room. Between their lines is included the peculiar portion of the iron line, and by making shots at it, as it were, in various directions from the neutral point of gold and palladium, we shall be able to study its bearings.

[Several of these experiments were shown, till finally the gold wire was melted.]

I have here wires of iron, gold, and palladium, bound together at one end, which is to be the hot junction. One end of the galvanometer coil is connected with the free end of the iron wire, the other slides along a long copper wire which connects the free ends of the gold and palladium wires. By sliding it towards either I diminish the resistance of that branch of the double arc and increase that in the other—*i.e.* I give that branch of the double arc the greater importance in the combination.

Throwing the greater part of the resistance into the palladium branch, I find a neutral point at a moderate temperature, but I cannot reach a second without melting the gold. Throw more resistance into the gold, the first neutral point occurs at a higher temperature than before, but a second is attainable. By still further increasing the resistance in the gold the two neutral points gradually approach one another, one rising in temperature the other descending, until at last we reach a maximum-minimum, the result of the confluence of the two points. The line for the double arc is now such as to *touch* the iron line. Still further increase the resistance of the gold, and we find a mere point of inflexion, the galvanometer indications having constantly *risen*, though at a retarded and then accelerated rate, during the heating of the junction.

Two of the platinum alloys which I employed with iron seem to give lines almost exactly parallel to the lead line—*i.e.* in them the specific heat of electricity is practically *nil*. When a circuit is formed of these alloys the current therefore depends upon the Peltier effects at the junctions alone, and is sensibly proportional to the difference of their absolute temperatures, thus furnishing a very convenient thermometer for the approximate estimation of high temperatures\*. I am at present engaged in drawing the thermo-electric diagram in terms of temperatures as given by this combination, and the reduction to absolute temperatures will finally be effected by a comparison of this temporary but very convenient standard with an air-thermometer.

\* This idea had been a little more fully developed in a paper read to the *British Association* in 1871. The following abstract is from the *Proceedings of Sections* at that Meeting, p. 48.

#### NOTE ON THERMO-ELECTRICITY.

It results from Thomson's investigations, founded on the beautiful discoveries of Peltier and Cumming, that the graphic representation of the electromotive force of a thermo-electric circuit, in terms of temperatures as abscissa, is a curve symmetrical about a vertical axis. This I have found to be, within the limits of experimental error, a parabola in each one of a very extensive series of investigations which I have made with wires of every metal I could procure. To verify this result with great exactness, and at the same time to extend the trial to temperatures beyond the range of a mercurial thermometer, I made a graphic representation, in which the abscissæ were the successive indications of one circuit, the ordinates those of another, the temperatures being the same in both. It is easy to see that if the separate circuits give parabolas (as above) in terms of temperature, this process also should lead to a parabola, the axis, however, being no longer vertical. This severe test was well borne, even to temperatures approaching a dull red heat. Unfortunately, it is difficult to procure wires of the more infusible metals, with the exception of platinum and palladium, so that I have not yet been able to push this test to very high temperatures. I hope, however, with the kind assistance of M. H. Sainte-Claire Deville, to have wires of nickel and cobalt, with which to test the parabolic law through a very wide range.

Parabolas being similar figures, it is easy to adjust the resistances in any two circuits so as to make their parabolas (in terms of temperature) *equal*. When this is done, if the neutral points be different, it is obvious that by making them act in opposite directions on a differential galvanometer we shall have deflections *directly proportional* to the temperature-differences of the junctions.

It is a curious result of this investigation, that, supposing the parabolic law to be true, the Peltier effect is also expressed by a parabolic function of temperature, vanishing at absolute zero.

I was led to this inquiry by a hypothetical application of the Dissipation of Energy to what Thomson calls the electric convection of heat, and my result is verified (within the range of my experiments), that the specific heat of electricity is directly proportional to the absolute temperature. It is scarcely necessary to point out that the above results appear to promise a very simple solution of the problem of measuring high temperatures, such as those of furnaces, the melting-points of rocks, &c.

## XXIX.

## FIRST APPROXIMATION TO A THERMO-ELECTRIC DIAGRAM.

[*Transactions of the Royal Society of Edinburgh*, Vol. XXVII. Read December 1, 1873.]

IN the Session of 1867-8 I communicated to this Society a paper on the *Dissipation of Energy*, of which only a very brief abstract was published in the *Proceedings*. [*Ante* No. XIV.] The main feature of that paper was the suggestion, as at least a valuable working hypothesis, that even in cases of the *steady* motion of heat, electricity, &c., the unexhausted energy is probably as small as possible, consistently with the conditions of each form of experiment.

Applied to the conduction of heat, this hypothesis was shown to lead to the result that thermal conductivity is inversely as the absolute temperature, a result closely agreeing with the experimental determinations of Forbes. A similar result follows (from the hypothesis) for electric conductivity, where it has long been known from experiment that the resistance is nearly proportional to the absolute temperature. As the latter experimental law, however, is subject to numerous exceptions, notably in the case of alloys, it was found necessary to introduce considerations of molecular change (such as alteration of specific heat, &c., with temperature); so that I determined to apply Forbes' methods as well as electric testing to other pure metals than iron, and also to an alloy such as German silver. The reduction of my observations is still far from complete, but I have already stated to the Society that the change of thermal conductivity by temperature in German silver is, like that of electric conductivity, certainly much less than in iron.

These experimental determinations involved very great difficulties of various kinds, so that it was not till 1870 that I had an opportunity of testing experimentally the working hypothesis above mentioned in its application to the very curious phenomena of thermo-electricity. After a few experiments, however, I found that (at least within

the limits where mercury thermometers can be employed) the so-called *Specific Heat of Electricity* is proportional to the absolute temperature, precisely the result indicated by the hypothesis. The following note is reprinted from the *Proceedings* of the Society for Dec. 19, 1870:—

“In a paper presented to the Society in 1867–8 I deduced from certain hypothetical considerations regarding Dissipation of Energy results connected with the thermal and electric conductivity of bodies, the electric convection of heat, &c. As these were all of a confessedly somewhat speculative character, I printed at the time only that connected with thermal conductivity, which I had the means of comparing with experiment, and which seemed to accord fairly with Forbes’ experimental results. But the assumption on which this was based was essentially involved in all the other portions of the paper.

“With a view to the testing of my hypothetical result as to electric convection of heat, several of my students, especially Messrs May and Straker, last summer made a careful determination of the electromotive force in various thermo-electric circuits through wide ranges of temperature. Their results for a standard iron-wire connected successively with two very different specimens of copper, when plotted, showed curves so closely resembling parabolas that I was led to look over my former investigations and determine what, on my hypothetical reasoning, the curves should be. This I had entirely omitted to do. I easily found that the parabola ought, on my hypothesis, to be the curve in every case, and I made last August a numerous and careful set of determinations with Kew standard mercurial thermometers as an additional verification.

“My hypothetical result was to the effect that what Thomson (*Trans. R.S.E.* 1854, *Phil. Trans.* 1856) calls the specific heat of electricity, should be, like thermal and electric resistance, directly proportional in pure metals to the absolute temperature, the coefficient of proportionality being, for some substances, negative.

“Hence, using Thomson’s notation as in *Trans. R.S.E.*, we have for any two metals

$$J\sigma_1 = k_1 t, \quad J\sigma_2 = k_2 t,$$

where  $k_1$  and  $k_2$  are constants, whose sign as well as value depends on the properties of each metal,  $\sigma_1$ ,  $\sigma_2$  are the specific heats of electricity, and  $J$  is Joule’s Equivalent.

“Thus, introducing these values into Thomson’s formulæ, we have

$$(k_1 - k_2) t = J(\sigma_1 - \sigma_2) = J\left(\frac{\Pi}{t} - \frac{d\Pi}{dt}\right),$$

where  $\Pi$  is the Peltier effect at a junction at absolute temperature  $t$ . Integrating, we have

$$C - (k_1 - k_2)t = J\frac{\Pi}{t},$$

or

$$J\frac{\Pi}{t} = (k_1 - k_2)(t_0 - t),$$

where  $t_0$  is the constant of integration, obviously in this case the temperature at

which the two metals are thermo-electrically neutral to one another. Hence the Peltier effect may be represented by the ordinates of a parabola of which temperatures are the abscissæ; the ordinates being parallel to the axis of the curve.

“The electromotive force in a circuit whose junctions are at absolute temperatures  $t$  and  $t'$  is then represented by

$$E = J \int_{t'}^t \frac{\Pi}{t} dt = \frac{1}{2} (k_1 - k_2) [2t_0 (t - t') - (t^2 - t'^2)] \\ = (k_1 - k_2) (t - t') \left[ t_0 - \frac{t + t'}{2} \right].$$

This, of course, is again the equation of a parabola. That  $t - t'$  is a factor of  $E$  has long been known, and Thomson has given the results of many experiments tending to show that  $t_0 - \frac{t + t'}{2}$  is also a factor. But it was not till the experiments in my Laboratory had been carried on for some months that I was referred by Thomson to a paper by Avenarius (*Pogg. Ann.* 119), in which it is experimentally proved (partly in contradiction of an assertion of Becquerel) that in a series of five different thermo-electric circuits the electromotive force can be very accurately expressed by *two* terms of the assumed series

$$E = b (t_1 - t_2) + c (t_1^2 - t_2^2) + \dots$$

where  $t_1$  and  $t_2$  are temperatures as shown by the ordinary mercurial thermometer. It follows from this that (neglecting the difference between absolute temperatures and those given by the mercurial thermometer)  $E$  has no other variable factor than those above given.

“Curiously enough, Avenarius, whose paper seems to have been written mainly for the purpose of attempting to explain (by the consideration merely of the effect of heat on electricity of contact of two metals) the production of thermo-electric currents, does not allude to the fact that the above equation represents a parabola. In fact he gives several figures, in all of which it is represented as a very accurately drawn *semicircle*. He makes no application of his empirical formula to the determination of the amount of the Peltier effect, nor does he seem to recognise the existence of what Le Roux has called ‘l’effet Thomson,’ which is indispensable to the explanation of the observed phenomena.

“All the curves plotted by Messrs May and Straker, which were derived from iron, copper, and platinum alone, as well as my own, which included cadmium, zinc, tin, lead, brass, silver, and various other substances (sometimes arranged with a double arc of two different metals connecting the hot and cold junctions) were excellent parabolas. When the temperatures were very high, the parabola was slightly steeper on the hotter than on the colder side. This, however, was a deviation of very small amount, and quite within the limits of error introduced by the altered resistance of the circuit at the hotter parts, the deviations of the mercury thermometers from absolute temperature, and the non-correction of the indication of the thermometers for the long column of mercury not immersed in the hot oil round the junction.

“To settle the question rigorously, I have been for some time experimenting with an arrangement sometimes of double metallic arcs, sometimes of two separate thermo-electric circuits acting on a differential galvanometer—a second object being to obtain, if it be possible, an arrangement capable of replacing with sufficient accuracy the air-thermometer in the measurement of very high temperatures, and where very exact results are not required.

“In fact, if the formula above be correct, we have for two circuits with their junctions immersed in the same vessels

$$E = a(t - t_1) \left( t_0 - \frac{t + t_1}{2} \right), \quad E' = a'(t - t_1) \left( t'_0 - \frac{t + t_1}{2} \right),$$

so that if the resistances in the circuits be made as  $a$  to  $a'$ , their resultant effect on the differential galvanometer will be proportional to

$$(t_0 - t'_0)(t - t_1).$$

“It is obvious that so far as these factors are concerned, the most sensitive arrangements will be such as have their neutral points farthest apart. On a future occasion I hope to lay the results of my new experiments before the Society. They appear to promise to be of great use in furnishing an easily working and approximately accurate substitute for the air-thermometer in an inquiry on which I am engaged respecting specific heats and melting points of various igneous rocks, &c., while the comparison of the indications of two such arrangements at very high temperatures will give the means of determining whether the quantities called  $k$  above are really constants.”\*

A year later (Dec. 18th, 1871) the following communication, giving rough materials for the construction of a thermo-electric diagram, was made to the Society, and appeared in the *Proceedings*:—

“For some time back I have been endeavouring to prove, by experiment, through great ranges of temperature, the result announced by me in December last, viz., that the electromotive force of a thermo-electric circuit is in general, unless the temperature be very high, a parabolic function of the absolute temperature of either junction, that of the other being maintained constant.

“For moderate ranges of temperature the experiment presents little difficulty; but when mercurial thermometers cannot be employed, a modification of the experimental method must be made. I have employed in succession several such modifications, of which the following are the chief:—

“The simplest of all is to dispense altogether with thermometers, and to employ two thermo-electric circuits, whose hot and whose cold junctions are immersed in the same vessels; and to plot the curve whose abscissæ and ordinates are simultaneous

\* In *Pogg. Ann.* 1873, Heft 7, which has just reached this country, there is another paper on this subject by Avenarius, in which he altogether deserts his earlier assumptions and line of reasoning, and comes to conclusions somewhat resembling those just quoted from my paper of 1870.

readings of the electromotive forces in the two circuits. In every case I have tried the curve thus obtained is almost accurately a parabola, most of the few deviations yet observed being in the case of silver and other metals at temperatures not very much below their melting points—under circumstances, in fact, in which we should naturally expect that the law would no longer hold. There are, also, cases in which the whole electromotive force is so small, even for very large differences of temperature, that very much more delicate apparatus would be required for their proper investigation. And there are cases in which the neutral point is so far off that for moderate ranges of temperature the curves obtained are sensibly straight lines. I intend to examine these cases with care—the former by using more delicate galvanometers, the latter by employing metals which are practically infusible. The difficulty of obtaining wires of such metals has been the chief one I have had to face.

“If we assume the experimental curve to be a parabola, then it is easily seen (*Proc.* May 29, 1871) that in each circuit the electromotive force must be a parabolic function of some function of the absolute temperatures of the junctions. And, as in the iron-silver, iron-zinc, iron-copper, iron-cadmium, &c., circuits, this function has been proved to be simply the absolute temperature itself (at least, within the range of mercury thermometers), it is probable that such is the general law, at least for ranges of temperature short of those which materially alter the molecular structure of the metals employed.

“The second method consisted in employing two pairs of circuits, all four hot junctions being in the same heated substance, and all four cold junctions kept at a common temperature. The members of each pair acted on a differential galvanometer (as explained in *Proc.* Dec. 19, 1870) in such a way as to eliminate the term containing the square of the absolute temperature. In this case the readings of the galvanometers should be simply proportional to one another, and likewise to the differences of absolute temperature of the junctions. The method is exact in theory, but by no means easy in practice, especially with the very limited number of metals capable of resisting a high temperature which I could manage to obtain. That a very exact and useful thermometric arrangement can be made on this principle admits of no doubt, when we examine the results of the experiments.

“The third method consisted in assuming the parabolic law, and the following consequence of it which follows directly by the use of Thomson’s general formulæ. These may easily be reproduced as follows:—Suppose a sliding ring or clip to be passed round the wires, so as to press together points of the wires which are at the same temperature,  $t$ . Its effects are known by experiment to be *nil*, whatever be its material. Let it be slid along so that the temperature of what is now effectively the hot junction becomes  $t + \delta t$ , then the two laws of thermodynamics give, respectively,

$$\delta E = J(\delta \Pi + (\sigma_1 - \sigma_2) \delta t),$$

and

$$0 = \delta \frac{\Pi}{t} + \frac{\sigma_1 - \sigma_2}{t} \delta t.$$

Here  $E$  is the electromotive force,  $\Pi$  the Peltier effect at a junction at temperature  $t$ , and  $\sigma_1, \sigma_2$ , are the specific heats of electricity in the two metals.



"Hence 
$$\delta E = J \left( \delta \Pi - t \delta \frac{\Pi}{t} \right) = J \frac{\Pi}{t} \delta t.$$

Introducing the hypothesis, obtained from considerations of Dissipation of Energy (*Proc.* Dec. 19, 1870), that

$$J\sigma_1 = k_a t, \quad J\sigma_2 = k_b t,$$

we have

$$J \frac{\Pi}{t} = \frac{dE}{dt} = (k_a - k_b)(T_{ab} - t),$$

where  $T_{ab}$  is the well-known 'neutral point.'

"Also 
$$E = (k_a - k_b)(t - t_1) \left( T_{ab} - \frac{t + t_1}{2} \right),$$

since it vanishes for  $t = t_1$ , the temperature of the cold junction. Now, if the neutral point be between such limits as  $0^\circ$  C. and  $300^\circ$  C., the exact determination of it is an easy matter; and this exact knowledge of it greatly facilitates the determination of  $\frac{dE}{dt}$ , which cannot be *very* accurately found by drawing a tangent to the plotted curve. For if one junction be at  $t$ , the other at  $T_{ab}$ , we have

$$E_r = \frac{1}{2} (k_a - k_b) (T_{ab} - t)^2.$$

$E_r$  and  $T_{ab} - t$  are easily measured on the experimental curve, and thus  $k_a - k_b$  is found. The following values have thus been (roughly) calculated from observations. Where the neutral point was not reached, it is put in brackets. The unit for  $k_a - k_b$  is 3 or 4 *per cent.* less than  $2 \cdot 10^{-5}$  of the electromotive force of a good Grove's cell.

	$T$	$k_a - k_b$		$T$	$k_a - k_b$
Fe—Cu (bad)	265 C.	-0.00147	Fe—Al	(387) C.	-0.00105
—Cu (good)	260	- .00145	„ —Arg.	(1357)	- .00045
„ —Cd	159	- .00209	Cu (bad) —Cd	-(23)	- .00081
„ —Zn	199	- .00189	„ —Zn	-(146)	- .00048
„ —Ag	235	- .00151	„ —Ag	-(687)	- .00006
„ —Pb	(357)	- .00112	„ (good) —Pb	-(213)	+ .00016
„ —Brass	(318)	- .00127	Pb—Cd	-(74)	- .00096
„ —Pt	(519)	- .00063	„ —Pd	-(188)	+ .00080
„ —Sn	(416)	- .00094	„ —Zn	-(78)	- .00060
„ —Pd	(1908)	- .00029	„ —Ag	-(262)	- .00026

"Now it is an immediate consequence of the second law of thermo-dynamics, that as Peltier effects are reversible with the direction of the current, and are the *only* sensible thermal effects when a very feeble current passes through a thermo-electric circuit all of whose parts are at one temperature, we must have

$$\sum \frac{\Pi}{t} = 0,$$

or, assuming the parabolic law,

$$\Sigma . (k_a - k_b) (T_{ab} - t) = 0.$$

This holds for any number of separate materials in the conductor. As  $t$  is the same throughout, the terms involving it evidently vanish identically; but there remains the equation

$$\Sigma . (k_a - k_b) T_{ab} = 0,$$

establishing a relation between the specific heats of electricity in a number of metals and the absolute temperatures of the neutral points of each junction of two of them. Other relations may be obtained by altering the order of the metals if there be more than three—but they are all virtually contained in the formula for three, which we write at full length,

$$(k_a - k_b) T_{ab} + (k_b - k_c) T_{bc} + (k_c - k_a) T_{ca} = 0.$$

From the direct experiments of Le Roux on "l'effet Thomson," as he calls it, it appears that  $k$  is null in lead\*. At all events, since Thomson showed that it has opposite signs in iron and copper, we may imagine a substance for which  $k=0$ . We may now construct an improved "Thermo-electric diagram" to represent these relations numerically, employing the line for this substance as our axis of absolute temperatures; while the ordinates perpendicular to it give, for this substance employed with any other in a circuit of two metals, the values of  $\frac{\Pi}{t}$ , or  $\frac{dE}{dt}$  or (what comes to the same thing) the electromotive force of a circuit whose junctions are both very nearly at  $t$ , but have a small constant temperature difference. This quantity corresponds with what has been called the *thermo-electric power* of the circuit.

"The two oblique *straight* lines in the diagram† belong to the metals  $a$ ,  $b$ , respectively. The tangents of their inclination to the horizontal axis (the line of the supposed metal for which  $k=0$ ) are  $k_a$ ,  $k_b$ —and they cut it at the points  $T_a$ ,  $T_b$ ,

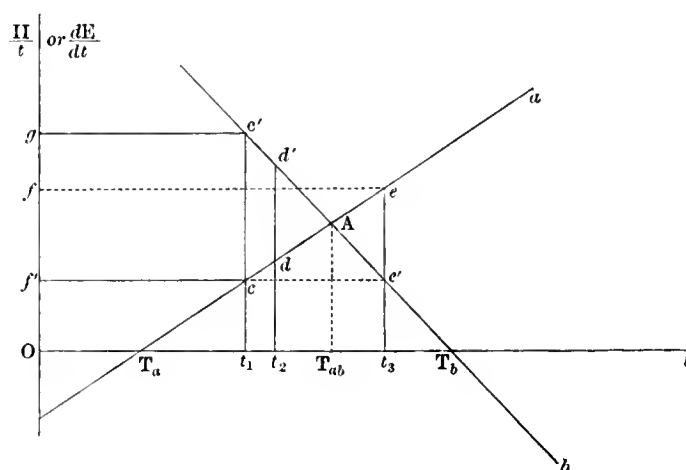

\* Annales de Chimie, 1867, Vol. x. p. 277.

† [A Note, which has not been reprinted, was appended to No. XXVIII. In its diagram lines parallel to the temperature-axis were drawn from  $d$  and  $d'$ , as well as from  $c$  and  $c'$ ; and thus the area  $c'd'dc$  was decomposed into the (algebraic) sum of its four constituents, the two Peltier, and the two Thomson, effects. 1897.]

where they are neutral to it; cutting one another at a point  $A$  whose abscissa is their own neutral point  $T_{ab}$ . The only change which would be introduced, by taking as horizontal axis the line corresponding to a metal for which  $k$  does not vanish, would be a dislocation of the diagram, by a simple shear. This follows at once from the equation of one of the lines—

$$y = k_a(x - T_a).$$

“The diagram gives the Peltier effect at the junction of  $a$  and  $b$  for any temperature  $t_1$ , by drawing the ordinate at  $t_1$ , and completing a rectangle  $cc'gf'$  on the part intercepted, its opposite end being at absolute zero. The area of this rectangle is to be taken positively or negatively according as the corner corresponding to  $a$  is nearer to, or further from, the horizontal axis than that corresponding to  $b$ , the current being supposed to pass from  $a$  to  $b$ .

“The electro-motive force in a circuit of the two metals  $a$  and  $b$ , with its junctions at  $t_1$  and  $t_2$  respectively, is found by drawing ordinates at these temperatures, so as to cut off triangular spaces  $Acc'$ ,  $Add'$ , whose vertices are at the neutral point. The difference of the areas of these spaces,  $cdd'c'$ , is proportional to the electro-motive force. When the higher temperature  $t_3$  is above the neutral point, the electro-motive force is the difference of the areas  $Acc'$ ,  $Aee'$ . The case above mentioned, in which, by a differential galvanometer, we get rid of the terms in  $t_2$ , is obviously a process for making the curves of two separate complex arrangements into parallel straight lines.

“In conclusion, I may give a few instances of the comparison of results of calculation of the neutral point of two metals from their observed neutral points, and differences of  $k$ , as regards iron, with calculation of the same neutral point from the portion of the curve (assumed to be a parabola) which expresses their electro-motive force within ranges of temperature where mercurial thermometers can be applied.

“Thus with Fe, Cd, Pb, we have from the iron circuits  $0\cdot00112 - 0\cdot00209 = -0\cdot00097$ , while the direct experiment with Cd, Pb gave  $-0\cdot00096$ .

“The neutral point, as calculated from the data for the iron circuits is  $-69^\circ\text{C}$ ., while the calculation from direct experiment gives  $-74^\circ\text{C}$ .

“When the quantities to be found are very small, as for instance in the case Ag—Cu, we cannot expect to get a good approximation by introducing a third metal. In fact, introducing Fe we find indirectly  $0\cdot00147 - 0\cdot00151 = -0\cdot00004$ , while the direct determination gives  $-0\cdot00006$ .

“Again with Zn and Cu, indirectly we get

$$-0\cdot00042 \text{ and } -144^\circ\text{C}.$$

Directly

$$-0\cdot00048 \text{ and } -146^\circ\text{C}.$$

“Several of the other groups give results as closely agreeing with one another as these, others are considerably out.

“The numerical determinations above are founded entirely on a series of experiments made for me by Messrs J. Murray and R. M. Morrison. Mr W. Durham is at present engaged in determining the electro-motive force of contact of wires of the same metal at different temperatures, with the view of inquiring into its relation to ordinary thermo-electric phenomena which appears to be suggested by some of the formulæ above given.”

Mr Durham's results were published in the *Proc. R.S.E.* (June 17th, 1872), and showed that in the case of platinum, the only metal he examined, the integral deflection of a somewhat massive galvanometer needle is independent of the absolute temperature of either wire, and proportional simply to the difference of their temperatures. This was the result I had expected from the formulæ given above (p. 223); for if

$$k_a = k_b,$$

we have

$$T_{ab} = \infty;$$

but consistently with these we may have

$$(k_a - k_b) T_{ab} = \tau,$$

a finite quantity. Hence

$$E = J\tau(t - t_1).$$

Various other communications on the subject were made by me to the Society, and published in the *Proceedings*; but of these I need quote only the following, of date June 3rd, 1872, as it shows a novel difficulty which I met with, and which prevented me from publishing earlier an attempt at constructing a thermo-electric diagram:—

“Having lately obtained from Messrs Johnson and Matthey some wires of platinum, and of alloys of platinum and iridium, I formed them into circuits with iron wire of commerce; and noticed that with all, excepting what is called ‘soft’ platinum, there is more than one neutral point situated below the temperature of low white heat, and that at higher temperatures other neutral points occur. This observation is, in itself, highly interesting; but my first impression was one of disappointment, as I imagined it depended on some peculiarity of the platinum metals, which I had hoped would furnish me with the means of accurately measuring high temperatures (by a process described in previous notes of this series). As this hope may possibly not be realised, I can as yet make only rough approximations to an estimation of the temperatures of these neutral points.

“So far as I am aware, the phenomenon discovered by Cumming and analysed by Thomson has hitherto been described thus: When the temperature of the cold junction is below the neutral point, the gradual raising of the temperature of the other produces a current which increases in intensity till the neutral point is reached, thenceforth diminishes; vanishes when one junction is about as much above the neutral point as the other is below it, and is *reversed* with gradually increasing

intensity as the hot junction is farther heated. To discover how my recent observation affects this statement, I first simply heated one junction of a circuit of iron and (hard) platinum gradually to whiteness, by means of a blowpipe, and observed the indications of a galvanometer—both during the heating and during the subsequent cooling when the flame was withdrawn. The heating could obviously not be effected at all so uniformly as the cooling; but, making allowance for this, the effects occurred in the opposite order, and very nearly at the same points of the scale in the descent and in the ascent. [I have noticed a gradual displacement of the neutral points when the junction was heated and cooled several times in rapid succession; but as my galvanometer, though it comes very quickly to rest, is not quite a *dead-beat* instrument, I shall not farther advert to this point till I have made experiments with an instrument of this more perfect kind, which is now being constructed for me.] The observed effect of heating, then, was a rise from zero to 110 scale divisions when the higher temperature was that of the first neutral point, then descent to 95 at a second neutral point, then ascent to a third, descent to a fourth, neither of which could be at all accurately observed, and finally ascent until the junction was fused.

“With an alloy of 15 per cent. iridium and 85 per cent. platinum, the galvanometer rose to 53·5 at a neutral point, then fell to -50 at a second, then rose to a third, at -39·5, and thence fell, but I could not observe a possible fourth neutral point on account of the fusion of the iron. As shown on the plate, the first of these occurs at about 240° C. of a mercurial thermometer.

“With another alloy supposed to be of the same metals, but of which I do not yet know the composition, also made into a junction with iron, the behaviour was nearly the same, but the readings at the successive neutral points were 28, -137, -132. The temperature of the first is about 200° C. by mercurial thermometer.

“An iron-palladium circuit showed no neutral points within the great range of temperatures mentioned above; though it showed a remarkable peculiarity which must be more closely studied, as it appears to point to the cause of the above effects in a property of iron. It was therefore employed to give (very roughly) an indication of the actual temperatures in these experiments. But as for this purpose it is necessary to measure the simultaneous indications of two circuits whose hot and whose cold junctions are respectively at the same temperatures, I was obliged to employ a steadier source of heat than the naked flame. I therefore immersed the hot junctions in an iron crucible containing borax glass, subsequently exchanged for a mixture of fused carbonate of soda and carbonate of potash; but, to my surprise, the former of these substances at a red heat disintegrated both the platinum and the alloy, and thus broke both circuits without sensibly acting on the iron, while the mixture (evidently by the powerful currents discovered by Andrews, *Phil. Mag.* 1837) interfered greatly with the indications of the thermo-electric circuit, as will be seen by the dotted curve in the wood-cut. [I may remark here that the deviations of this curve

from its form when these currents are prevented are quite easily observed and plotted by the process next to be mentioned, so that the study of the Andrews effect may be carried out with great accuracy by my method.] Finally, determining to dispense altogether with fused salts, which conduct too well besides acting on the metals, I simply suspended a red-hot bombshell, vent downwards, in such a way that the hot junction was near its centre. This arrangement worked admirably, until a white heat was required, for this melted the shell. In its place a wrought-iron tube (an inch in bore, four inches long, half an inch thick, and closed at the upper end) has been substituted, and answers excellently. It does not cool too fast for accurate reading at the higher temperatures, and by elevating it by degrees from over the hot junction we can make the cooling fast enough at the lower ranges. In fact, I believe that if I do not succeed in getting a sufficient number of practically infusible metals to construct my proposed thermometric arrangement, I may be able to make a fair approximation to temperatures by simple time observations made with the hot tube, surrounded by some very bad conductor, such as sand, where the surface in contact with the air is always comparatively cool, and where therefore we can accurately calculate the rate of cooling.

“Curves I., II., III., in the woodcut were drawn by means of this apparatus. The hot junction consisted of an iron wire, a palladium wire, and (for the several curves in order)—I. Hard platinum; II. Pt 85, Ir 15; III. The other alloy of Pt

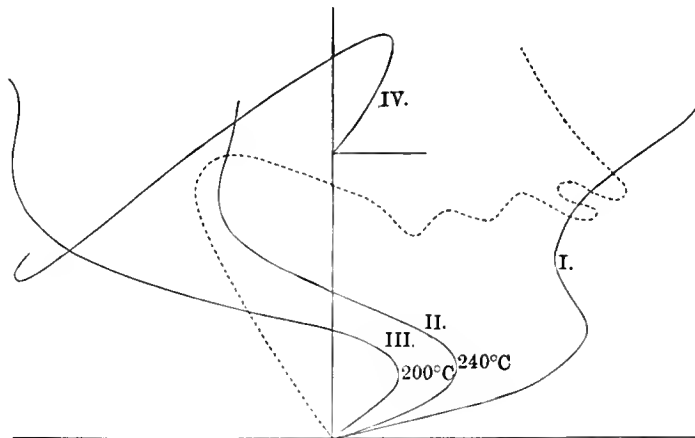

and Ir. The free ends of the palladium wire, and of the platinum or alloy, were joined to iron wires, and the junctions immersed in test-tubes filled with water resting side by side in a large vessel of cold water. The other ends of these three iron wires, and the wires of the galvanometer, were led to a sort of switch, by means of which either circuit could be instantly made to include the galvanometer. Readings were taken of each circuit as fast after one another as possible (with the galvanometer I employed about 6.5 seconds was the *necessary* interval), and the mean of

two successive readings of one circuit was taken as being at the same temperature as that of the intermediate reading of the other.

“The indications of these curves are very curious as regards the effect of even small impurities on the thermo-electric relations of some metals. It is probable, from analogy, that the curve for iron and *pure* platinum, in terms of temperature, would be (approximately, at least; even if it should be the iron, and not the platinum metal, which is represented by a broken or curved line) a parabola with a very distant vertex. And it appears probable that when the wire of curve III. is analysed it will be found to contain even a larger percentage of iridium (?) than that of curve II.

“I find by tracing these curves on ground glass, allowing for the difference between temperatures and the indications of an Fe-Pd circuit, and superposing them on a nest of parabolas with a common vertex and axis, that they can be closely represented by successive portions of different parabolas (with parallel axes) whose tangents coincide at the points of junction, though the *curvature* is necessarily not continuous from one to the other. Hence, as at least a fair approximation to the electro-motive force in terms of difference of temperature in the junctions, we may assume a parabolic function, which up to a certain temperature belongs to one parabola, then changes to another without discontinuity of direction, and so on.

“Hence either the iron, or the hard platinum and the platinum-iridium alloys, will be (approximately, at least) represented on my form of Thomson's thermo-electric diagram (*ante*, p. 224) by *broken* lines, of which the successive parts are straight. This, contrasted with the (at least nearly) straight lines for pure metals, seems to show that some bodies take successively different states (*i.e.*, become *different substances*) at certain ‘critical’ temperatures, retaining their thermo-electric properties nearly unchanged from one of those critical points to another.

“The curve marked IV. in the woodcut was obtained by plotting against each other the simultaneous indications of the alloy of curve III. and iron, and of the alloy of curve II. and iron, so as to avoid any disturbance from possible peculiarities of palladium. Then, to obtain an idea of the share taken by iron in the results, it was found that the electro-motive force in a circuit formed by the two alloys, or by either with hard Pt, is (for a very great range of temperature) sensibly proportional to the temperature difference of the junctions.

“The same result is easily seen from the plate, if we notice that the difference of corresponding ordinates in any two of curves I., II., III., is nearly proportional to the corresponding abscissa. Now, it seems a less harsh supposition that the lines representing platinum and its alloys are nearly straight and parallel, while that of iron is a broken line, than that the latter should be straight and the former all broken at the same temperatures. On the other hand, this latter hypothesis would make  $k$  alternately negative and positive in iron, while the former would only require the platinum metals to have values of  $k$  alternately less and more negative than that of iron.

"I may add that none of the above-mentioned effects can be due to altered electric resistance of the heated junctions, because the galvanometer resistance was about 23 B.A. units, while that of the iron and platinum wires together was in each case not more than one such unit. The palladium-iron circuit was so much more powerful than the others that a resistance coil of about 146 B.A. units had to be inserted in its course....."

To this paper was added during printing the following postscript:—"I have since made out that the lines of the diagram are approximately straight, and parallel to the lead line, for the platinum metals, that of hard platinum being below the lead line, while those of most of the other alloys are above it, and that the multiple neutral points depend upon the peculiar sinuosity of the line for iron. I have also obtained curious results of a somewhat similar kind with steel wire. The method I employed was to explore the part of the thermo-electric diagram included between the lines of gold and palladium, by making a multiple arc of these two metals, and varying the ratio of their separate resistances. But I reserve details until I have carefully examined the behaviour of nearly pure iron."

The peculiarity thus exhibited by iron I afterwards found to be also possessed by nickel, and with the farther advantage that the changes of sign of specific heat of electricity occur in that metal at temperatures within the range of mercury thermometers. (*Proc. R.S.E.*, May 1873.) These results I developed in the *Rede Lecture* of 1873, a full abstract of which was printed in *Nature* [*ante*, No. XXVIII.], and to this I refer the reader for some speculations as to the connection of these phenomena with known chemical and magnetic relations, as well as for a great deal of additional matter connected with Thermo-electricity, but not so directly connected with my present subject, the construction of a Thermo-electric Diagram.

I have given this *résumé* of a few of my former papers to show how I was led to attempt the construction of a thermo-electric diagram, by the result of experiments originally devised to test the truth of a hypothetical application of the Dissipation of Energy.

The following results were obtained mainly during the summer of the present year, the experiments being in great part made by Messrs C. E. Greig and C. G. Knott in my laboratory. The extracts above show sufficiently the nature of the processes employed, so that but a very few remarks need be made about the thermo-electric diagram (Plate I.), which is constructed from them, and embraces the greater part of the temperature-region in which mercury thermometers can be used. Metals like bismuth and antimony are quite beyond the capabilities of even a double plate on this scale.

1. A very small amount of impurity, or even of permanent strain, is capable of considerably altering the line of a metal in the diagram; so that I have given in general a sort of average position to each line, and have not attempted absolute exactness where it was obviously not requisite nor even desirable. N is the alloy





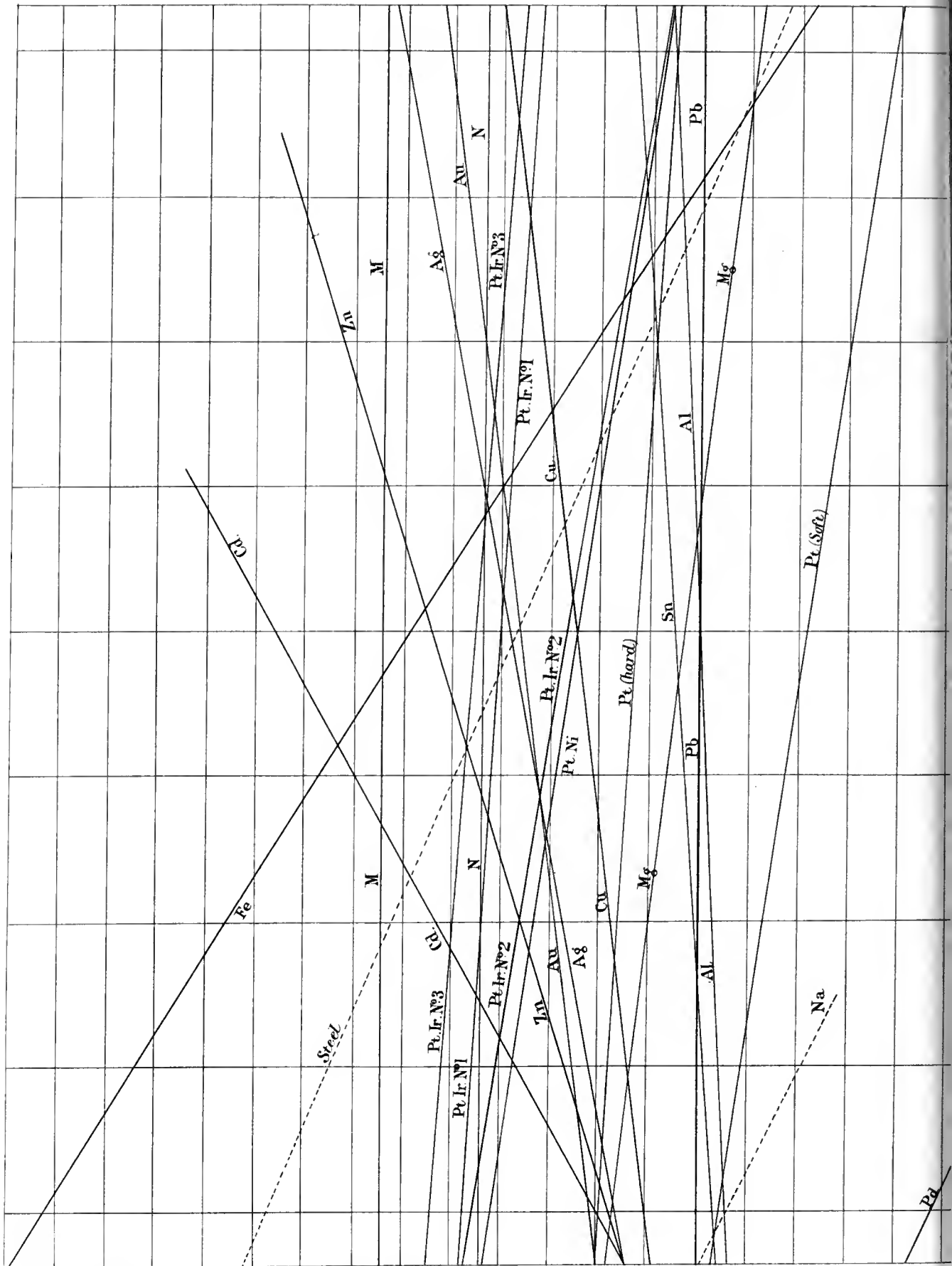

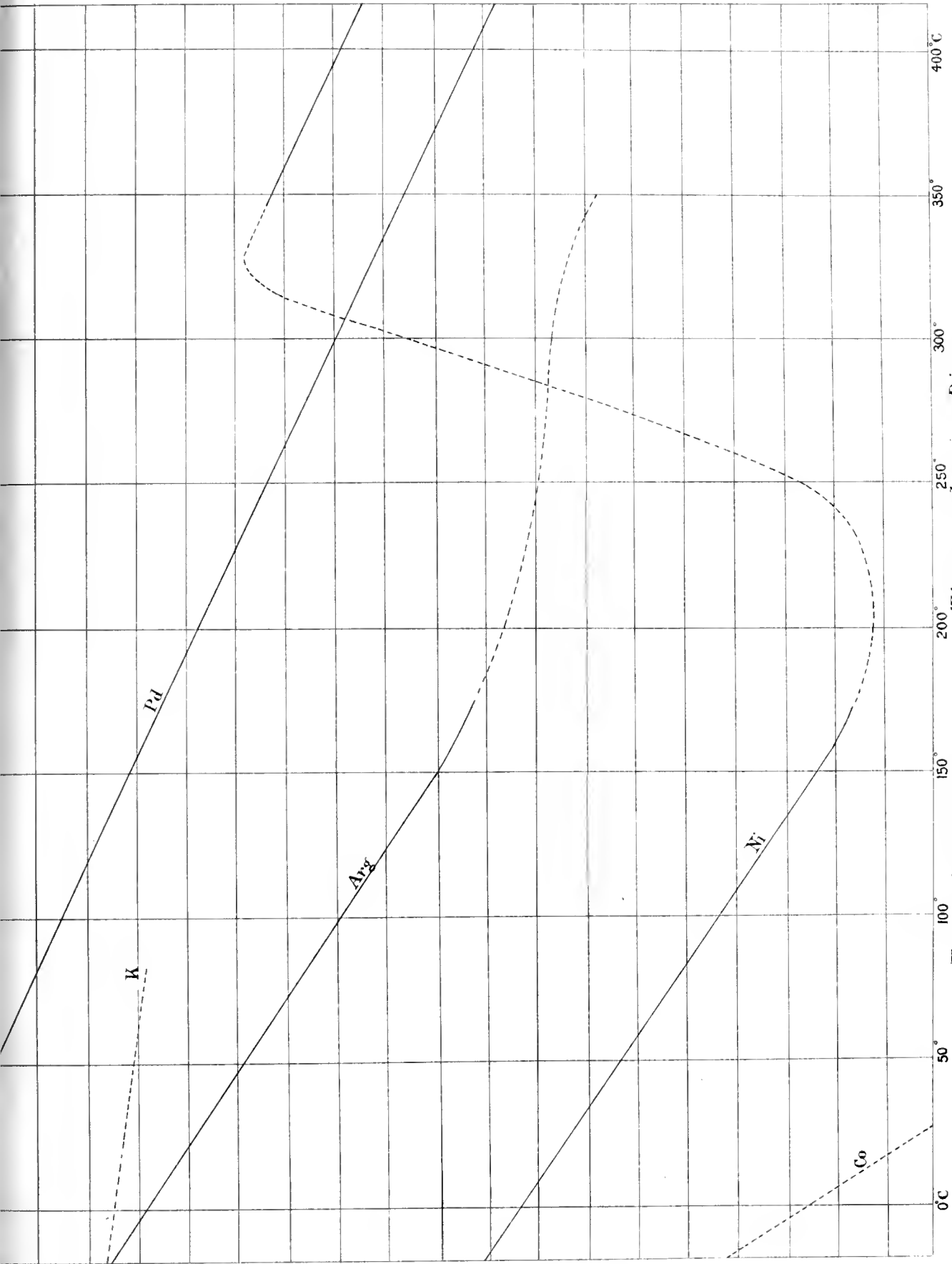

First Approximation to a Thermo - electric Diagram.

W. J. ...



of 15 Ir, 85 Pt described in the last extract above, M is the other alloy. Nos. 1, 2, 3 denote platinum-iridium alloys containing respectively 5, 10, 15 per cent. of the latter metal. These were prepared for me from pure metals by Messrs Johnson and Matthey, as I fancied from the behaviour of M and N that I might get a series of alloys whose lines should be parallel to that of lead. The result does not for the present appear encouraging.

2. I have not yet been able to arrive at any definite conclusion with regard to the form of the dotted portions in the lines of nickel and of German silver. In fact, had it not been that the palladium line intersects that of nickel near the middle of the most interesting region, I might have missed altogether the detection of the peculiarities of nickel, though I was led to seek for them near that region by induction from those of iron. It is obvious, in fact, from the diagram, that had copper, gold, iron, &c., been associated with nickel, the modification due to these peculiarities would have been only a very small fraction of the whole electro-motive force, and might easily have been attributed to errors of observation. As it is, my best specimen of pure nickel has been destroyed by exposure several times to a white heat, and I must wait for another before I can resume this part of the inquiry.

3. Having made no direct experiments on the electric convection of heat in lead, I have retained its line as the axis, on the authority of Le Roux above alluded to. As already stated, this is a question involving the *actual* specific heat of electricity in each metal; not the *difference* of the specific heats in any two metals, which is all that my experiments furnish.

Subject to these remarks we have the following table of the values of  $k$ , whose contents are represented graphically in Plate I., and where the unit of electro-motive force employed is nearly  $10^{-5}$  of a Grove's cell. The tangents of the inclinations of the lines in the plate may be reduced to the corresponding numerical values of  $k$  in terms of a Grove's cell by the factor  $4 \times 10^{-6}$ .

Fe	-·00247	Cd	+·00218
Steel	-·00171	Zn	+·00122
M	-·00000	Ag	+·00076
Pt Ir (No. 1)	-·00028	Au	+·00052
Pt Ir (No. 2)	-·00068	Cu	+·00048
Pt Ir (No. 3)	-·00032	Pb	·00000
N	-·00000	Sn	+·00028
Pt (soft)	-·00056	Al	+·00020
Pt Ni	-·00056	Pd	-·00182
Pt (hard)	-·00038	Ni (to 175° C.)	-·00260
Mg	-·00048	Ni (250°—310° C.)	+·01225
Arg	-·00260	Ni (from 340° C.)	-·00260

Plate II. shows directly the galvanometric indications of circuits including various iron and steel wires; one of which is a ribbon of pure iron, prepared by

Dr Matthiessen, kindly put at my disposal by Dr Russell. The other specimens of iron consist of two from the ordinary stock in my laboratory, and a third (probably, from its position so close to that of Dr Matthiessen, very pure) which I owe to Sir R. Christison, who has used portions of it for chemical testing for more than thirty years. It was, therefore, prepared at a time when more care was employed to secure purity than in the present day. The circuits were completed by the platinum alloy called N above, whose line is nearly parallel to that of lead, but a little above it. The temperature scale is the temporary one given by the galvanometric indications of the two platinum alloys M and N. Their lines are drawn as almost exactly parallel in Plate I., but they intersect at some temperature about a white heat; so that to reduce the diagram to something roughly corresponding to absolute temperatures, the whole must be extended parallel to the temperature axis, and in ratios continually increasing for higher ranges of temperature. The experimental work on which this diagram is based has been performed almost entirely by Messrs C. G. Knott and C. Michie Smith, and its general accuracy may be estimated by the smoothness of the curves obtained: particularly as all the observed points which do not lie *exactly* on the curves have been inserted in the diagram.

The points of contrary flexure in these curves correspond to the points of change of sign of specific heat of electricity in the specimens of iron and steel, and it is obvious that it is a matter of great difficulty to estimate with precision where they lie. The wire called B Thin shows so remarkable a resemblance to steel in its thermo-electric properties—though it is certainly not steel—that, as a verification, I tried the electro-motive force of a circuit formed of it and of B Thick which so nearly coincides with pure iron. The result is given by the lower curve in Plate II., which is easily seen to be in entire agreement with the curves in the upper part of the plate, the ordinates of one being the differences of those of the other two.

In Plate III. I have endeavoured, by drawing tangents to the curves of Plate II., to construct (to the same distorted temperature-scale) the thermo-electric diagram for N, and the various specimens of iron and steel. It will be seen that all of these specimens have at least two changes of sign of the specific heat of electricity. It is to be remarked, however, that as the heating of the junctions was effected by means of a white-hot iron cylinder (as described in one of the extracts above), the diagram belongs to specimens of iron and steel which have been raised to a white heat and are cooling. This process generally produces a marked change in the thermo-electric properties of steel, though a very slight one in those of iron.

In the same Plate, III., I have attempted (by means of the parabolic law, assumed for M, N) to approximate to the diagram for pure iron in terms of absolute temperature. The result is indicated by a double line, which may be compared with the line for nickel in Plate I., to which it has more than a mere general resemblance. But this figure also shows one way of forming a thermo-electric circuit which shall give a

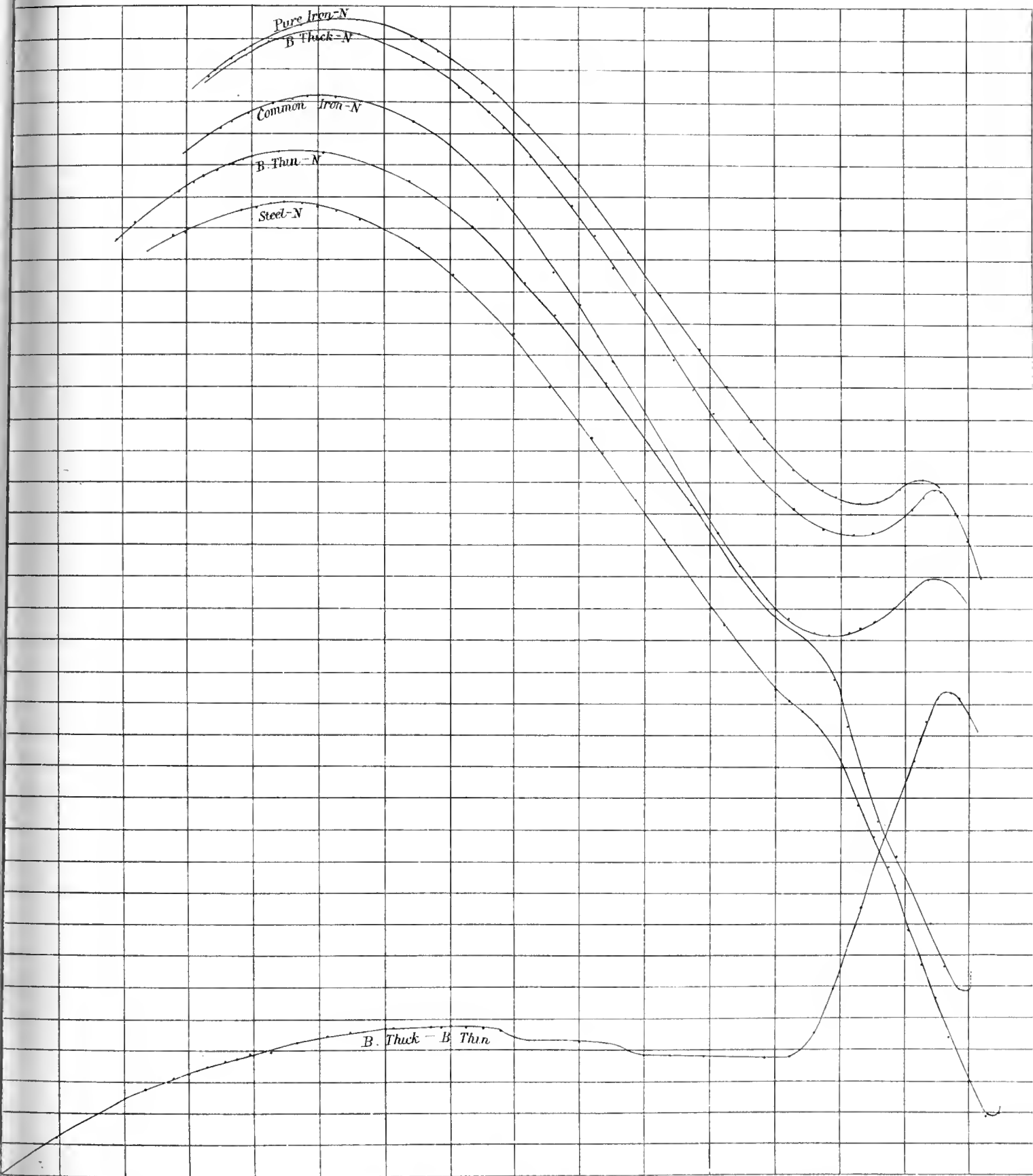

0°C

To follow p. 232.

Temporary Scale M-N

Red Heat

White Heat





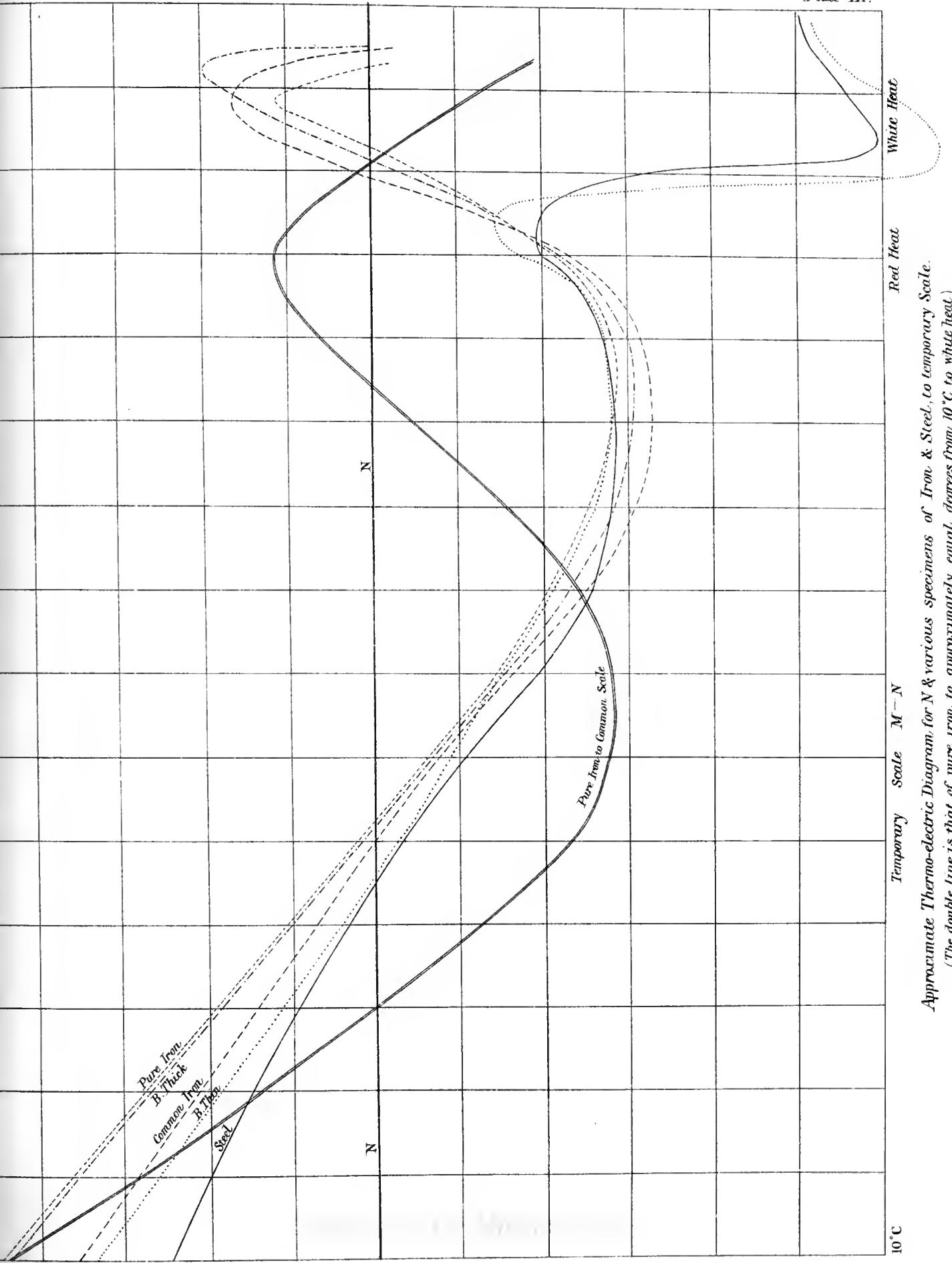

Approximate Thermo-electric Diagram for N & various specimens of Iron & Steel, to temporary scale.  
(The double line is that of pure iron to approximately equal degrees from 10°C to white heat)



current without any Peltier effect at either junction, and without electric convection of heat in one of the two metals concerned.

*Note.*—Since this paper was read to the Society I have seen in the *Phil. Mag.* for December 1873 a paper by Prof. Barrett, in which he recalls attention to Mr Gore's singular observation regarding the sudden changes of length which take place in an iron wire at a low red heat, and adds his own very curious discovery of the sudden glow which occurs simultaneously with them. I have for some time been seeking for other physical changes, besides the well-known magnetic ones, and the above described thermo-electric ones, which may be expected to take place in iron about this temperature. A brief note on the change of electric resistance of iron appears in *Proc. R.S.E.* (Dec. 16, 1872) as a first instalment which I hope soon to be able considerably to extend.

[The lines of Na, K, and Co have been inserted in the reprint of the Diagram from the following data; given to the Royal Society of Edinburgh on March 2, and 16, 1874; and March 6, 1876, respectively.

	Na	K	Co
Sp. Heat of Electricity	- '00212	- '00066	- '00585
Neutral Point	(with Pb) - 20° C.	(with Arg) - 20°	(with Pb) - 228°.

With reference to some remarks in the two preceding articles, the following investigation of the first effects of a current on the distribution of temperature in a conducting wire may be appended.

Let the wire at a point  $x$  have, at time  $t$ , the absolute temperature  $v$ ; and let its electric resistance and the temperature-gradient be both small, so as to avoid, as far as possible, resistance-heating and conduction. The heat developed per unit of time in the portion  $\delta x$  is measured from one point of view by  $c \frac{dv}{dt} \delta x$ , where  $c$  is the water-equivalent per unit of length. But it is also proportional to  $-\sigma \delta v$ , i.e. to  $-kv \frac{dv}{dx} \delta x$ , and to the strength of the current. Thus we have the equation

$$a \frac{dv}{dt} = -kv \frac{dv}{dx},$$

in which  $a$  may be treated as constant.

The complete integral is 
$$v = f\left(x - \frac{kt}{a} v\right);$$

where  $f$  is an arbitrary function, expressing the distribution of temperature at  $t=0$ .

Generally, while  $t$  is small, this gives the relation

$$v = \frac{f(x)}{1 + \frac{kt}{a} f'(x)}.$$

In particular if, initially, we have throughout a uniform temperature-gradient

$$v = ex,$$

then, while none but thermo-electric processes are sensibly at work,

$$v = \frac{ex}{1 + ket/a}.$$

Thus, in the standard case (when  $e$  and  $k$  are both positive) the temperature-gradient becomes less steep; and it does so because the temperatures are simultaneously diminished in the same ratio. 1886.]

XXX.

NOTE ON THE TRANSFORMATION OF DOUBLE AND TRIPLE INTEGRALS.

[*Proceedings of the Royal Society of Edinburgh, December 1, 1873.*]

1. If we have two equations of the form

$$f(u, v, \xi, \eta) = 0,$$

$$F(u, v, \xi, \eta) = 0,$$

$u$  and  $v$  are given as functions of  $\xi$  and  $\eta$ , or *vice versa*. Here either  $u$  and  $v$ , or  $\xi$  and  $\eta$ , may be the ordinary Cartesian  $x$  and  $y$ , or any given functions of them.

Now, if we write with Hamilton, since we are dealing with two independent variables only,

$$\nabla = i \frac{d}{dx} + j \frac{d}{dy},$$

we have

$$\nabla = \nabla_u \frac{d}{du} + \nabla_v \frac{d}{dv} = \nabla_\xi \frac{d}{d\xi} + \nabla_\eta \frac{d}{d\eta} \dots\dots\dots(1).$$

The proof may be easily given in a Cartesian form by operating by  $S_i$  and  $S_j$  separately. For the former operation gives

$$\frac{d}{dx} = \frac{du}{dx} \frac{d}{du} + \frac{dv}{dx} \frac{d}{dv} = \frac{d\xi}{dx} \frac{d}{d\xi} + \frac{d\eta}{dx} \frac{d}{d\eta},$$

equations manifestly true.

2. Now, the elementary area included by the curves  $u, u + \delta u, v, v + \delta v$ , is easily seen to be [See, for instance, No. VI. above. 1897.]

$$\frac{\delta u \delta v}{TV \nabla u \nabla v}.$$

Hence we have the following transformations of a double integral extended over a given area:—

$$\iint P dx dy = \iint P \frac{du dv}{TV \nabla u \nabla v} = \iint P \frac{d\xi d\eta}{TV \nabla \xi \nabla \eta}.$$

But by (1) we see at once that

$$TV \nabla \xi \nabla \eta = \begin{vmatrix} \frac{d\xi}{du} & \frac{d\xi}{dv} \\ \frac{d\eta}{du} & \frac{d\eta}{dv} \end{vmatrix} TV \nabla u \nabla v,$$

whence, of course, the general proposition

$$\begin{vmatrix} \frac{d\xi}{du} & \frac{d\xi}{dv} \\ \frac{d\eta}{du} & \frac{d\eta}{dv} \end{vmatrix} \begin{vmatrix} du & dv \\ d\xi & d\eta \end{vmatrix} = 1,$$

and the common transformation

$$\iint P dx dy = \iint P \begin{vmatrix} \frac{dx}{du} & \frac{dx}{dv} \\ \frac{dy}{du} & \frac{dy}{dv} \end{vmatrix} du dv.$$

3. Dealing with triple integrals,  $\nabla$  takes the ordinary Hamiltonian form, and an additional term is added to each of the members of (1), which thus at once gives us the mode of introducing  $\nabla$  into any system of curvilinear co-ordinates.

The element of volume included by the surfaces  $u, u + \delta u, v, v + \delta v, w, w + \delta w$ , is easily seen to be expressed by

$$-\frac{\delta u \delta v \delta w}{S \cdot \nabla u \nabla v \nabla w}.$$

Hence we have the following—

$$\iiint P dx dy dz = - \iiint P \frac{du dv dw}{S \cdot \nabla u \nabla v \nabla w} = - \iiint P \frac{d\xi d\eta d\zeta}{S \cdot \nabla \xi \nabla \eta \nabla \zeta}.$$

From these we have, besides the more complex transformation from  $u, v, w$ , to  $\xi, \eta, \zeta$ ,

the common one

$$\iiint P dx dy dz = - \iiint P \begin{vmatrix} \frac{dx}{du} & \frac{dx}{dv} & \frac{dx}{dw} \\ \frac{dy}{du} & \frac{dy}{dv} & \frac{dy}{dw} \\ \frac{dz}{du} & \frac{dz}{dv} & \frac{dz}{dw} \end{vmatrix} du dv dw,$$

and also the general theorem

$$\begin{vmatrix} \frac{d\xi}{du} & \frac{d\xi}{dv} & \frac{d\xi}{dw} \\ \frac{d\eta}{du} & \frac{d\eta}{dv} & \frac{d\eta}{dw} \\ \frac{d\zeta}{du} & \frac{d\zeta}{dv} & \frac{d\zeta}{dw} \end{vmatrix} \begin{vmatrix} du & dv & dw \\ d\xi & d\eta & d\zeta \end{vmatrix} = 1.$$

## XXXI.

NOTE ON THE VARIOUS POSSIBLE EXPRESSIONS FOR THE  
FORCE EXERTED BY AN ELEMENT OF ONE LINEAR CON-  
DUCTOR ON AN ELEMENT OF ANOTHER.

[*Proceedings of the Royal Society of Edinburgh, December 1, 1873.*]

IN the *Quart. Math. Journal* for 1860 (No. III. above), I gave a quaternion process for obtaining in a very simple manner, from Ampère's experimental data, his well-known expression for the mutual action between two elements of currents. As one of the data the assumption was made, after Ampère, that the action is a force whose direction is that of the line joining the middle points of the elements, *i.e.*, it was assumed that the necessary equality of action and reaction holds, not merely for two closed circuits but, for each pair of elements of these circuits. I promised in that paper to publish a more general investigation, in which no such assumption should be made; but I was prevented from doing this by having seen a reference to a memoir by Cellerier, in which it was stated that such an investigation had been given. I did not, till very recently, succeed in getting any information about that memoir, none of which seems indeed to have been printed except a very brief extract in the *Comptes Rendus* for 1850, vol. xxx., giving no details: but the subject was recalled to my memory by Clerk-Maxwell's *Treatise on Electricity, &c.*, in which there is an investigation of the possible expressions for the forces which satisfy Ampère's data without necessarily satisfying his assumption. Both of these authors make the undetermined part of the expression depend upon a single arbitrary function. My investigation leads to two. The question is one of comparatively little physical importance, but I give this investigation for its extreme simplicity.

The following is, as nearly as I can recollect, my original process, which has, at least at first sight, nothing in common with that of Clerk-Maxwell.

1. Ampère's data for closed currents are briefly as follows:—

I. Reversal of either current reverses the mutual effect.

II. The effect of a sinuous or zig-zag current is the same as that of a straight or continuously curved one, from which it nowhere deviates much.

III. No closed current can set in motion a portion of a circular conductor movable about an axis through its centre, and perpendicular to its plane.

IV. In similar systems, traversed by equal currents, the forces are equal.

2. First, let us investigate the expression for the *force* exerted by one element on another.

Let  $\alpha$  be the vector joining the elements  $\alpha_1, \alpha'$ , of two circuits; then, by I., II., the vector action of  $\alpha_1$  on  $\alpha'$  is *linear* in each of  $\alpha_1, \alpha'$ , and may, therefore, be expressed as

$$\phi\alpha',$$

where  $\phi$  is a linear and vector function, into each of whose constituents  $\alpha_1$  enters linearly.

The resolved part of this along  $\alpha'$  is

$$S. U\alpha'\phi\alpha',$$

and, by III., this must be a complete differential as regards the circuit of which  $\alpha_1$  is an element. Hence,

$$\phi\alpha' = -(S. \alpha_1 \nabla) \psi\alpha' + V\alpha'\chi\alpha_1,$$

where  $\psi$  and  $\chi$  are linear and vector functions whose constituents involve  $\alpha$  only. That this is the case follows from the fact that  $\phi\alpha'$  is homogeneous and linear in each of  $\alpha_1, \alpha'$ . It farther follows, from IV., that the part of  $\phi\alpha'$  which does not disappear after integration round each of the closed circuits is of no dimensions in  $T\alpha, T\alpha', T\alpha_1$ . Hence  $\chi$  is of  $-2$  dimensions in  $T\alpha$ , and thus

$$\chi\alpha_1 = \frac{p\alpha S\alpha\alpha_1}{T\alpha^4} + \frac{q\alpha_1}{T\alpha^2} + \frac{rV\alpha\alpha_1}{T\alpha^3},$$

where  $p, q, r$  are numbers.

Hence we have

$$\phi\alpha' = -S(\alpha_1 \nabla) \psi\alpha' + \frac{pV\alpha'\alpha S\alpha\alpha_1}{T\alpha^4} + \frac{qV\alpha'\alpha_1}{T\alpha^2} + \frac{rV.\alpha'V\alpha\alpha_1}{T\alpha^3}.$$

Change the sign of  $\alpha$  in this, and interchange  $\alpha'$  and  $\alpha_1$ , and we get the action of  $\alpha'$  on  $\alpha_1$ . This, with  $\alpha'$  and  $\alpha_1$  again interchanged, and the sign of the whole changed, should reproduce the original expression—since the effect depends on the relative, not the absolute, positions of  $\alpha, \alpha_1, \alpha'$ . This gives at once,

$$p = 0, \quad q = 0,$$



and

$$\phi\alpha' = -S(\alpha_1\nabla)\psi\alpha' + \frac{rV\cdot\alpha'V\alpha\alpha_1}{T\alpha^3},$$

with the condition that the first term changes its sign with  $\alpha$ , and thus that

$$\psi\alpha' = \alpha S\alpha'F(T\alpha) + \alpha'F(T\alpha),$$

which, by change of  $F$ , may be written

$$= \alpha S(\alpha'\nabla)f(T\alpha) + \alpha'F(T\alpha),$$

where  $f$  and  $F$  are any scalar functions whatever.

Hence

$$\phi\alpha' = -S(\alpha_1\nabla)[\alpha S(\alpha'\nabla)f(T\alpha) + \alpha'F(T\alpha)] + \frac{rV\cdot\alpha'V\alpha\alpha_1}{T\alpha^3},$$

which is the general expression required.

3. The simplest possible form for the action of one current-element on another is, therefore,

$$\phi\alpha' = \frac{rV\cdot\alpha'V\alpha\alpha_1}{T\alpha^3}.$$

Here it is to be observed that Ampère's *directrice* for the circuit  $\alpha_1$  is

$$\theta = \int \frac{V\alpha\alpha_1}{T\alpha^3},$$

the integral extending round the circuit; so that, finally,

$$\phi\alpha' = -rS\alpha_1\nabla\cdot V\alpha'\theta.$$

4. We may obtain from the general expression above the absolutely symmetrical form,

$$\frac{rV\cdot\alpha'\alpha_1}{T\alpha^3},$$

if we assume

$$f(T\alpha) = \text{const.}, \quad F(T\alpha) = \frac{r}{T\alpha}.$$

Here the action of  $\alpha'$  on  $\alpha_1$  is parallel and equal to that of  $\alpha_1$  on  $\alpha'$ . The forces, in fact, form a couple, for  $\alpha$  is to be taken negatively for the second—and their common direction is the vector drawn to the corner  $a$  of a spherical triangle  $abc$ , whose sides  $ab$ ,  $bc$ ,  $ca$  in order are bisected by the extremities of the vectors  $U\alpha'$ ,  $U\alpha$ ,  $U\alpha_1$ . Compare Hamilton's *Lectures on Quaternions*, §§ 223—227.

5. To obtain Ampère's form for the effect of one element on another write, in the general formula above,

$$f(T\alpha) = \frac{r}{T\alpha}, \quad F(T\alpha) = 0,$$

and we have

$$\begin{aligned} \frac{1}{r} \phi \alpha' &= -S \alpha_1 \nabla \left[ -\frac{\alpha S \alpha \alpha'}{T \alpha^3} \right] + \frac{V \cdot \alpha' V \alpha \alpha_1}{T \alpha^3} \\ &= -\frac{\alpha_1 S \alpha \alpha'}{T \alpha^3} - \frac{\alpha S \alpha_1 \alpha'}{T \alpha^3} - \frac{3 \alpha S \alpha \alpha' S \alpha \alpha_1}{T \alpha^5} + \frac{V \cdot \alpha' V \alpha \alpha_1}{T \alpha^3} \\ &= +\frac{2 \alpha}{T \alpha^5} \left( \alpha^2 S \alpha_1 \alpha' - \frac{3}{2} S \alpha \alpha' S \alpha \alpha_1 \right) \\ &= -\frac{2 \alpha}{T \alpha^5} \left( S \cdot V \alpha \alpha' V \alpha \alpha_1 + \frac{1}{2} S \alpha \alpha' S \alpha \alpha_1 \right), \end{aligned}$$

which are the usual forms.

6. The remainder of the expression, containing the arbitrary terms, is of course still of the form

$$-S(\alpha_1 \nabla) [\alpha S \alpha' \nabla \cdot f(T \alpha) + \alpha' F(T \alpha)].$$

In the ordinary notation this expresses a force whose components are proportional to

(1) Along  $\alpha$ , 
$$-r \frac{d^2 f}{ds_1 ds'}$$

(Note that, in *this* expression,  $r$  is the distance between the elements.)

(2) Parallel to  $\alpha'$ , 
$$\frac{dF}{ds_1}$$

(3) Parallel to  $\alpha_1$ , 
$$-\frac{df}{ds'}$$

If we assume  $f = F = -Q$ , we obtain the result given by Clerk-Maxwell (*Electricity and Magnetism*, § 525), which differs from the above only because he assumes that the force exerted by one element on another when the first is parallel and the second perpendicular to the line joining them is *equal* to that exerted when the first is perpendicular and the second parallel to that line.

7. What precedes is, of course, only a particular case of the following interesting problem:—

*Required the most general expression for the mutual action of two rectilinear elements, each of which has dipolar symmetry in the direction of its length, and which may be resolved and compounded according to the usual kinematical law.*

The data involved in this statement are equivalent to I. and II. of Ampère's data above quoted. Hence, keeping the same notation as in § 2 above, the force exerted by  $\alpha_1$  on  $\alpha'$  must be expressible as

$$\phi \alpha',$$

where  $\phi$  is a linear and vector function, whose constituents are linear and homogeneous in  $\alpha_1$ ; and, besides, involve only  $\alpha$ .

By interchanging  $\alpha_1$  and  $\alpha'$ , and changing the sign of  $\alpha$ , we get the force exerted by  $\alpha'$  on  $\alpha_1$ . If in this we again interchange  $\alpha_1$  and  $\alpha'$ , and change the sign of the whole, we must obviously reproduce  $\phi\alpha'$ . Hence we must have  $\phi\alpha'$  changing its sign with  $\alpha$ , or

$$\phi\alpha' = P\alpha S\alpha_1\alpha' + Q\alpha S\alpha_1 S\alpha\alpha' + R\alpha_1 S\alpha\alpha' + \mathbf{R}\alpha' S\alpha\alpha_1$$

where  $P, Q, R, \mathbf{R}$  are functions of  $T\alpha$  only.

8. The vector *couple* exerted by  $\alpha_1$  on  $\alpha'$  must obviously be expressible in the form

$$V. \alpha' \varpi \alpha_1,$$

where  $\varpi$  is a new linear and vector function depending on  $\alpha$  alone. Hence its most general form is

$$\varpi \alpha_1 = P\alpha_1 + Q\alpha S\alpha\alpha_1,$$

where  $P$  and  $Q$  are new functions of  $T\alpha$  only. The form of these functions, whether in the expression for the force or for the couple, depends on the special data for each particular case. Symmetry shows that there is no term such as

$$R V\alpha\alpha_1.$$

9. As an example, let  $\alpha_1$  and  $\alpha'$  be elements of solenoids or of uniformly and linearly magnetised wires.

It is obvious that, as a closed solenoid or ring-magnet exerts no external action,

$$\phi\alpha' = -S\alpha_1 \nabla \cdot \psi\alpha'.$$

Thus we have introduced a different datum in place of Ampère's No. III. But in the case of solenoids the Third Law of Newton holds—hence

$$\phi\alpha' = S\alpha_1 \nabla S\alpha' \nabla \cdot \chi\alpha,$$

where  $\chi$  is a linear and vector function, and can therefore be of no other form than

$$\alpha f(T\alpha).$$

Now two solenoids, each extended to infinity in one direction, act on one another like two magnetic poles, so that (this being our equivalent for Ampère's datum No. IV.)

$$\chi\alpha = p \frac{\alpha}{T\alpha^3}.$$

Hence the vector force exerted by one small magnet on another is

$$p S\alpha_1 \nabla S\alpha' \nabla \cdot \frac{\alpha}{T\alpha^3}.$$

10. For the couple exerted by one element of a solenoid, or of a uniformly and longitudinally magnetised wire, on another, we have of course the expression

$$V. \alpha' \varpi \alpha_1,$$

where  $\varpi$  is some linear and vector function.

Here, in the first place, it is obvious that

$$\varpi\alpha_1 = -S\alpha_1\nabla \cdot \frac{\alpha}{F(T\alpha)};$$

for the couple vanishes for a closed circuit of which  $\alpha_1$  is an element, and the integral of  $\varpi\alpha_1$  must be a linear and vector function of  $\alpha$  alone. It is easy to see that in this case

$$F(T\alpha) \propto (T\alpha)^3.$$

11. If, again,  $\alpha_1$  be an element of a solenoid, and  $\alpha'$  an element of current, the force is

$$\phi\alpha' = -S\alpha_1\nabla \cdot \psi\alpha',$$

where

$$\psi\alpha' = P\alpha' + Q\alpha S\alpha\alpha' + RV\alpha\alpha'.$$

But no portion of a solenoid can produce a force on an element of current in the direction of the element, so that

$$\phi\alpha' = V\alpha'\chi\alpha_1,$$

so that

$$P = 0, \quad Q = 0,$$

and we have

$$\phi\alpha' = -S\alpha_1\nabla (RV\alpha\alpha').$$

This must be of  $-1$  linear dimensions when we integrate for the effect of one pole of a solenoid, so that

$$R = \frac{p}{T\alpha^3}.$$

If the current be straight and infinite each way, its equation being

$$\alpha = \beta + x\gamma,$$

where

$$T\gamma = 1 \text{ and } S\beta\gamma = 0,$$

we have, for the whole force exerted on it by the pole of a solenoid, the expression

$$p\beta\gamma \int_{-\infty}^{+\infty} \frac{dx}{(T\beta^2 + x^2)^{\frac{3}{2}}} = -2p\beta^{-1}\gamma,$$

which agrees with known facts.

12. Similarly, for the couple produced by an element of a solenoid on an element of a current we have

$$V\alpha'\varpi\alpha_1,$$

where

$$\varpi\alpha_1 = -S\alpha_1\nabla \cdot \psi\alpha,$$

and it is easily seen that

$$\psi\alpha = \frac{r\alpha}{T\alpha^2}.$$

13. In the case first treated, the couple exerted by one current-element on another is (§ 8, above)

$$V. \alpha' \varpi \alpha_1,$$

where, of course,  $\pm \varpi \alpha_1$  are the vector forces applied at either end of  $\alpha'$ . Hence the work done when  $\alpha'$  changes its direction is

$$-S. \delta \alpha' \varpi \alpha_1,$$

with the condition

$$S. \alpha' \delta \alpha' = 0.$$

So far, therefore, as change of direction of  $\alpha'$  alone is concerned, the mutual potential energy of the two elements is of the form

$$S. \alpha' \varpi \alpha_1.$$

This gives, by the expression for  $\varpi$  in § 8, the following value

$$PS\alpha'\alpha_1 + QS\alpha\alpha'S\alpha\alpha_1.$$

Hence, integrating round the circuit of which  $\alpha_1$  is an element, we have (*On Green's and other Allied Theorems*, § 11, No. XIX. above)

$$\begin{aligned} \int (PS\alpha'\alpha_1 + QS\alpha\alpha'S\alpha\alpha_1) &= \iint ds_1 S. U_{\nu_1} \nabla (P\alpha' + Q\alpha S\alpha\alpha'), \\ &= \iint ds_1 S. U_{\nu_1} \left( \frac{\alpha\alpha' P'}{T\alpha} - \alpha'\alpha Q \right), \\ &= \iint ds_1 S. U_{\nu_1} V\alpha\alpha'\Phi, \end{aligned}$$

where

$$\Phi = \frac{P'}{T\alpha} + Q.$$

Integrating this round the other circuit we have for the mutual potential energy of the two, so far as it depends on the expression above, the value

$$\begin{aligned} &\iint ds_1 S. U_{\nu_1} \int V\alpha\alpha'\Phi \\ &= -\iint ds_1 S U_{\nu_1} \iint ds' V. V(U_{\nu'} \nabla) \alpha\Phi \\ &= \iint ds_1 \iint ds' \left\{ S U_{\nu_1} U_{\nu'} (2\Phi + T\alpha\Phi') + S\alpha U_{\nu'} S\alpha U_{\nu_1} \frac{\Phi'}{T\alpha} \right\}. \end{aligned}$$

But, by Ampère's result, that two closed circuits act on one another as two magnetic shells, it should be

$$\begin{aligned} &\iint ds_1 \iint ds' S U_{\nu_1} \nabla S U_{\nu'} \nabla \frac{1}{T\alpha} \\ &= \iint ds_1 \iint ds' \left( S. U_{\nu_1} U_{\nu'} \frac{1}{T\alpha^3} + 3S\alpha U_{\nu'} S\alpha U_{\nu_1} \frac{1}{T\alpha^5} \right). \end{aligned}$$

Comparing, we have

$$\left. \begin{aligned} \frac{1}{T\alpha^2} &= 2\Phi + T\alpha\Phi' \\ \frac{3}{T\alpha^3} &= T\alpha\Phi' \end{aligned} \right\},$$

giving 
$$\Phi = -\frac{1}{T\alpha^3}, \quad \Phi' = \frac{3}{T\alpha^4},$$

which are consistent with one another, and lead to

$$\frac{P'}{T\alpha} + Q = -\frac{1}{T\alpha^3}.$$

Hence, if we put

$$Q = \frac{1-n}{2nT\alpha^3},$$

we get

$$P = \frac{1+n}{2nT\alpha},$$

and the mutual potential of two elements is of the form

$$(1+n) \frac{S\alpha'\alpha_1}{T\alpha} + (1-n) \frac{S\alpha\alpha'S\alpha\alpha_1}{T\alpha^3},$$

which is the expression employed by Helmholtz in his recent paper. (*Ueber die Bewegungsgleichungen der Electricität, Crelle, 1870, p. 76.*)

## XXXII.

## ON A SINGULAR THEOREM GIVEN BY ABEL.

[*Proceedings of the Royal Society of Edinburgh, December 21, 1874.*]

THE theorem in question, in its simplest form, is

$$\pi f(x) = \int_0^x \frac{dy}{\sqrt{x-y}} \int_0^y \frac{f'(\xi) d\xi}{\sqrt{y-\xi}}.$$

Abel's proof of it involves the properties of the gamma-function, and requires that  $f'(\xi)$  should be capable of development in powers of  $\xi$ . (*Œuvres*, i. 27.)

Independently of the interesting kinetic application for which it was originally designed, this result is very curious, as suggesting a form of the *square root* of the operation of simple integration. In fact it gives

$$\left(\frac{d}{dx}\right)^{-\frac{1}{2}}( ) = \frac{1}{\sqrt{\pi}} \int_0^x \frac{( ) dy}{\sqrt{x-y}}.$$

Seeking to obtain an elementary proof of Abel's result, which should at the same time be applicable to any function, whether developable or not, I hit upon the simple expedient of inverting the order of the two integrations. We thus get the proof immediately in the form

$$\int_0^x \int_0^y \frac{dy f'(\xi) d\xi}{\sqrt{x-y} \sqrt{y-\xi}} = \int_0^x \int_\xi^x \frac{f'(\xi) d\xi dy}{\sqrt{x-y} \sqrt{y-\xi}}.$$

Now it is known (and a simple geometrical proof is easily given) that

$$\int_\xi^x \frac{dy}{\sqrt{x-y} \sqrt{y-\xi}} = \pi.$$

Hence the integral becomes at once

$$\pi [f(x) - f(0)].$$

Numerous extensions and applications of the theorem are given.

As one example of these extensions the following, which assigns an expression for  $\left(\int_0^x\right)^n$ , may here be given—

$$\int_0^{x_1} \frac{dx_2}{(x_1 - x_2)^{\frac{n-1}{n}}} \int_0^{x_2} \frac{dx_3}{(x_2 - x_3)^{\frac{n-1}{n}}} \dots \int_0^{x_n} \frac{f'(\xi) d\xi}{(x_n - \xi)^{\frac{n-1}{n}}} = E_1 E_2 \dots E_{n-1} [f(x_1) - f(0)].$$

Here

$$E_r = \int_0^1 \frac{de}{(1-e)^{\frac{n-1}{n}} e^{\frac{n-r}{n}}},$$

and therefore

$$E_1 E_2 \dots E_{n-1} = \frac{\Gamma\left(\frac{1}{n}\right) \Gamma\left(\frac{1}{n}\right)}{\Gamma\left(\frac{2}{n}\right)} \cdot \frac{\Gamma\left(\frac{1}{n}\right) \Gamma\left(\frac{2}{n}\right)}{\Gamma\left(\frac{3}{n}\right)} \dots \frac{\Gamma\left(\frac{1}{n}\right) \Gamma\left(\frac{n-1}{n}\right)}{\Gamma(1)} = \left(\Gamma\left(\frac{1}{n}\right)\right)^n.$$

Hence

$$\left(\frac{d}{dx}\right)^{-\frac{1}{n}} ( ) = \frac{1}{\Gamma\left(\frac{1}{n}\right)} \int_0^x \frac{( ) dy}{(x-y)^{\frac{n-1}{n}}}.$$

The theorem given by Abel is easily seen to be the particular case of this when  $n = 2$ , for then

$$\left(\Gamma\left(\frac{1}{2}\right)\right)^2 = \pi.$$

Another form of the above multiple integral is easily seen to be

$$x_1 \int_0^1 \frac{e_1^{\frac{n-1}{n}} de_1}{(1-e_1)^{\frac{n-1}{n}}} \int_0^1 \frac{e_2^{\frac{n-2}{n}} de_2}{(1-e_2)^{\frac{n-1}{n}}} \dots \int_0^1 \frac{f'(e_1 e_2 \dots e_n x_1) de_n}{(1-e_n)^{\frac{n-1}{n}}};$$

and curious expressions for  $\left(\frac{d}{dx}\right)^{-\frac{2}{n}}$  (when  $n$  is even) may be obtained by evaluating the integral

$$\int_0^{x_1} \frac{dx_2}{(x_1 - x_2)^{\frac{2(n-1)}{mn}}} \int_0^{x_2} \frac{dx_3}{(x_2 - x_3)^{\frac{2(m-1)(n-1)}{mn}}} \dots \int_0^{x_{n-1}} \frac{dx_n}{(x_{n-1} - x_n)^{\frac{2(n-1)}{mn}}} \int_0^{x^n} \frac{f'(\xi) d\xi}{(x^n - \xi)^{\frac{2(m-1)(n-1)}{mn}}}$$

where  $m$  is any real quantity whatever.

Other instances of the use of this process were adduced, but those just given are sufficient for an abstract like the present.



## XXXIII.

## ON A FUNDAMENTAL PRINCIPLE IN STATICS.

[*Proceedings of the Royal Society of Edinburgh, December 21, 1874.*]

THE principle that, while additional constraints cannot disturb equilibrium, unnecessary constraints may be removed without disturbing equilibrium, is of very great use in the statics of fluids and of elastic and flexible bodies. But it seems not to have been made use of to the extent its importance deserves.

My attention was recalled to it when attempting to compare the shares taken by gravity and cohesion in resisting the tendency of the so-called centrifugal force to split a planet. The problem which first proposed itself was to determine the gravitation attraction of one-half of a uniform sphere upon the other.

The sextuple integral which a direct solution of this problem would require may be entirely dispensed with, and its place supplied by a simple single integral, if we imagine a thin film of the solid on each side of a diametral plane to be converted (without change of bulk or density) into an incompressible liquid.

Or we may commence with a sphere of homogeneous incompressible liquid. If  $a$  be its radius,  $\rho$  its density, it is easily shown that the whole pressure normal to any diametral plane—which is of course the attraction of the hemispheres on one another—is

$$\frac{1}{3} \pi^2 \rho^2 a^4.$$

If each hemisphere were collected at its centre of inertia the attraction would be  $\left(\frac{4}{3}\right)^2$  times as great.

The centrifugal force tending to split the planet across a diametral plane through the axis (it is easily shown to be greater per unit of area on a diametral than on any other plane) is

$$\frac{1}{4} \pi \rho \omega^2 a^4,$$

where  $\omega$  is the angular velocity of rotation. The ratio of these is

$$\frac{\frac{4}{3} \pi \rho a}{a \omega^2}$$

or the ratio of gravity to centrifugal force at any point on the equator. Hence, so far as gravity is concerned, the earth would split across a meridian if it were to revolve more than seventeen times faster than it does.

It is known that, if the earth revolved seventeen times faster than it does, centrifugal force would just balance gravity at the equator. The relation of this fact to the above statement depends upon the geometrical proposition that the volume of a very small slice from the surface of a sphere is half the product of its thickness by the area of its base.

And cohesion would not sensibly alter this state of things; for, assuming the earth's diameter to be 8000 miles, its mean density 5.5, and the weight of a cubic foot of water at the surface 63 lbs., while the average tensile strength of its materials is taken as 500 lbs. weight per square inch, the cohesion between the hemispheres is shown to be only  $\frac{1}{25,410}$ th part of their gravitation attraction.

Even if we made the extreme assumption that the tensile strength is (throughout) that of steel, cohesion would in the case of the earth be only about  $\frac{1}{100}$ th of gravitation attraction between hemispheres.

As a consequence, a planet of the earth's mean density and the above assumed tensile strength is held together as much by cohesion as by gravitation if its radius is  $\frac{1}{\sqrt{25,410}}$ th of that of the earth, or about 25 miles. If of steel's tenacity it would have a radius of about 409 miles.

## XXXIV.

ON THE APPLICATION OF SIR W. THOMSON'S DEAD-BEAT  
ARRANGEMENT TO CHEMICAL BALANCES.

[*Proceedings of the Royal Society of Edinburgh, February 15, 1875.*]

A CONSIDERABLE amount of time is lost in making an accurate weighing on account of the slowness of oscillation of the balance when the loads are nearly equal:—and this loss of time is nearly proportional to the delicacy or sensitiveness of the balance.

Hence it becomes a matter of importance to endeavour to bring the balance speedily to rest without, if possible, impairing its sensitiveness:—as thus much time and labour would be saved in weighing.

Several methods of applying gaseous friction for this purpose have been tried by me of late. By far the most successful consists in suspending from the beam, either within or beyond the scale-pans, two very light closed cylinders which fit closely (but without touching) into two fixed cylinders open at the top only. Applied to a long and massive beam with considerable loads in its scale-pans, which vibrated for some minutes when disturbed, this trial apparatus brought it to rest after, at most, *three* half vibrations.

It is now evident that, with a damper properly constructed on this plan, there is practically no limit (so far as rapidity of weighing alone is concerned) to the length which may be given to a balance-beam; and, of course, no limit to the consequent sensibility of the instrument.

A very instructive hydrokinetical illustration is afforded by this instrument. The closed cylinder, exactly balanced inside the cylinder open at the top, is made to ascend briskly by a gentle current of air blown even vertically downwards on the centre of its upper end.

XXXV.

ON THE LINEAR DIFFERENTIAL EQUATION OF THE SECOND ORDER.

[*Proceedings of the Royal Society of Edinburgh, January 3, 1876.*]

THIS paper contains the substance of investigations made for the most part many years ago, but recalled to me during last summer by a question started by Sir W. Thomson, connected with Laplace's theory of the tides.

A comparison is instituted between the results of various processes employed to reduce the general linear differential equation of the second order to a non-linear equation of the first order. The relation between these equations seems to be most easily shown by the following obvious process, which I lit upon while seeking to integrate the reduced equation by finding how the arbitrary constant ought to be involved in its integral.

Let  $u$  and  $v$  be any functions of  $x$ ,

$$\xi = \frac{A \frac{du}{dx} + B \frac{dv}{dx}}{Au + Bv} = \frac{u' + Cv'}{u + Cv} \dots\dots\dots(1),$$

where  $B$  and  $A$ , and therefore their ratio  $C$ , are arbitrary constants. The elimination of  $C$  from (1) must of course give a differential equation of the first order in  $\xi$ .

We have 
$$\xi' = \frac{u'' + Cv''}{u + Cv} - \left( \frac{u' + Cv'}{u + Cv} \right)^2.$$

Now we have, by adding and subtracting multiples of (1), &c.,

$$\xi' = \frac{u'' + Pu' + Qu + C(v'' + Pv' + Qv)}{u + Cv} - \left( \frac{u' + Cv'}{u + Cv} \right)^2 - P\xi - Q;$$

whence, if  $u$  and  $v$  are independent integrals of the equation

$$y'' + Py' + Qy = 0 \dots\dots\dots(2),$$

we have the required equation

$$\xi' + \xi^2 + P\xi + Q = 0;$$

and the process above shows why it takes this particular form.

But (2) gives  $y = Au + Bv$

as the complete integral, so we see that

$$\frac{y'}{y} = \xi.$$

Various classes of cases in which this form is integrable are given, of which the following is one:—

Let  $\xi = \eta\sqrt{Q}$ , then the equation becomes integrable in the form

$$\frac{\eta'}{\eta^2 + m\eta + 1} + \sqrt{Q} = 0 \dots\dots\dots(3),$$

provided

$$P\sqrt{Q} + \frac{1}{2} \frac{Q'}{\sqrt{Q}} = mQ,$$

i.e.,

$$\frac{e^{-\int P dx}}{\sqrt{Q}} = -m \int e^{-\int P dx} dx.$$

The next subject treated is the effect of the alteration of sign of  $P$  or  $Q$  in (2). This is illustrated by the equation

$$y'' \pm xy' \pm y = 0,$$

which is integrable or at least reducible to quadratures for any of the four combinations of sign.

The always integrable case where

$$P = (C - x)Q$$

is next examined.

Another portion of the investigation deals with certain infinite but convergent series, whose sums can always be expressed in terms of the integral of a linear differential equation of the second order.

Consider, for instance, the expansion

$$e^{px + \frac{1}{x}} = \left(1 + px + \dots + \frac{p^n x^n}{n!} + \dots\right) \times \left(1 + \frac{1}{x} + \dots + \frac{1}{x^n \cdot n!} + \dots\right) \dots\dots\dots(4). \\ = \sum P_n x^n, \text{ suppose.}$$

Obviously we have  $P_n = p^n P_{-n} = \frac{p^n}{n!} + \frac{p^{n+1}}{1!(n+1)!} + \frac{p^{n+2}}{2!(n+2)!} + \dots$

From this at once  $\frac{dP_n}{dp} = P_{n-1}$ , whence  $P_n = (\int dp)^n P_0 \dots\dots\dots(5).$

Also 
$$\frac{d}{dp} \left( \frac{P_n}{p^n} \right) = \frac{P_{n+1}}{p^{n+1}}, \text{ whence } P_n = p^n \left( \frac{d}{dp} \right)^n P_0 \dots \dots \dots (6).$$

Eliminating  $P_n$  between (5) and (6), we obtain

$$P_0 = \left( \frac{d}{dp} \right)^n p^n \left( \frac{d}{dp} \right)^n P_0 \dots \dots \dots (7).$$

This equation is thus true for all positive integral values of  $n$ , and its form at once shows that it is true for negative integral values also. It is very singular that such a series of equations of all orders should have a common solution. But it depends upon the fact, which I do not recollect having seen in print, that

$$\left( \frac{d}{dx} x \frac{d}{dx} \right)^n = \left( \frac{d}{dx} \right)^n x^n \left( \frac{d}{dx} \right)^n.$$

This can be verified at once by applying it to  $x^n$ ; as can also the companion formula

$$\left( x \frac{d}{dx} x \right)^n = x^n \left( \frac{d}{dx} \right)^n x^n.$$

Suppose we had, instead of (5) and (6),

$$\frac{dQ_n}{dq} = Q_{n+1} \dots \dots \dots (5'),$$

$$\frac{d}{dq} (q^n Q_n) = q^{n-1} Q_{n-1} \dots \dots \dots (6')$$

we should find the *same equation* (7) for  $Q_0$  as for  $P_0$ . In fact, as is easily seen,

$$Q_n = P_n.$$

Other pairs which alike give the equation

$$R_0 = \left( \frac{d}{dr} \right)^n r^{-n} \left( \frac{d}{dr} \right)^n R_0 \dots \dots \dots (7')$$

are

$$\frac{dR_n}{dr} = R_{n+1}, \quad \frac{d}{dr} \left( \frac{R_n}{r^n} \right) = \frac{R_{n-1}}{r^{n-1}}$$

and

$$\frac{dS_n}{ds} = S_{n-1}, \quad \frac{d}{ds} (s^n S_n) = s^{n+1} S_{n+1}.$$

We thus get the two distinct particular integrals of each of the corresponding differential equations.

More generally,

$$\left( \frac{d}{dp} \right)^v P_n = P_{n-v},$$

and

$$\frac{P_n}{p^n} = \left( \frac{d}{dp} \right)^v \frac{P_{n-v}}{p^{n-v}};$$

whence

$$P_{n-v} = \left( \frac{d}{dp} \right)^v p^n \left( \frac{d}{dp} \right)^v \frac{P_{n-v}}{p^{n-v}}.$$

Changing  $n - \nu$  to  $m$ , this becomes

$$P_m = \left(\frac{d}{dp}\right)^{-m} \left\{ \left(\frac{d}{dp}\right)^n p^n \left(\frac{d}{dp}\right)^n \right\} \left(\frac{d}{dp}\right)^{-m} \frac{P_m}{p^m},$$

which, when  $m = 0$ , agrees with (7). Here  $n$  may have any positive integral value not less than  $m$ . When we write  $n = m$  we have merely a truism. If we put  $n = m + 1$ , we arrive at the same result as we should have obtained directly from the *first* forms of the equations (5) and (6). All these series satisfy differential equations of the form

$$x \frac{d^2y}{dx^2} - (n - 1) \frac{dy}{dx} = y.$$

Corresponding properties are easily proved for the series forming the coefficients of the various powers of  $x$  in the expansions of expressions like

$$\epsilon^{px^m + \frac{1}{x^n}}, \quad \epsilon^{px + \frac{t}{x}}, \quad \&c., \quad \&c.$$

It is easily seen that what has been called  $P_0$  above is the infinite series

$$P_0 = 1 + \frac{p}{1^2} + \frac{p^2}{1^2 \cdot 2^2} + \frac{p^3}{1^2 \cdot 2^2 \cdot 3^2} + \dots = f(p) \dots \dots \dots (8),$$

and that quite generally if

$$\Pi_m = 1 + \frac{p}{1^m} + \frac{p^2}{1^m \cdot 2^m} + \frac{p^3}{1^m \cdot 2^m \cdot 3^m} + \&c.$$

we have

$$\Pi_m = \left(\frac{d}{dp}\right)^n \left(p^n \left(\frac{d}{dp}\right)^{m-1} \Pi_m\right)$$

whatever positive integer be represented by  $n$ . Of this the simplest case is  $\Pi_1 = \epsilon^p$ , where of course

$$\left(\frac{d}{dp}\right)^n \Pi_1 = \Pi_1.$$

Again, just as the solution of this equation has the property

$$\epsilon^p \epsilon^q = \epsilon^{p+q},$$

so it is easy to see that we have in (8)

$$f(p)f(q) = f(\overline{p+q}),$$

where the bracket over  $p + q$  is employed to indicate that in the expansion we must *square* the numerical coefficients of each term of a power of this binomial, *i.e.*,

$$\begin{aligned} \overline{p+q} &= p+q, \\ \overline{p+q}^2 &= p^2 + q^2 + 2^2pq, \\ \overline{p+q}^3 &= p^3 + q^3 + 3^2(p^2q + pq^2), \\ \overline{p+q}^4 &= p^4 + q^4 + 4^2(p^3q + pq^3) + 6^2p^2q^2, \\ &\&c., \qquad \qquad \qquad \&c., \end{aligned}$$

and a similar property, though of course involving higher powers of the coefficients, holds for each of the functions  $\Pi_m$  above.

For the product of any two similar expansions (with different variables) is easily seen to have all its numerical coefficients raised to any given power when those of the separate expansions are so raised.

The paper contains also an account of various attempts to solve the general equation of the second order, of which the following may be noted.

a. Transform to 
$$\frac{d^2y}{dx^2} - Xy = 0,$$

and evaluate 
$$\iint \frac{1}{y} \frac{d^2y}{dx^2} dx^2$$

at once, just as 
$$\int \frac{1}{y} \frac{dy}{dx} dx$$

is evaluated. The difficulty is reduced to finding the value of

$$\iint \left(\frac{dy}{dx}\right)^2 dx^2,$$

where a *single* operation is to be effected. [See a sort of *converse* of this notion in No. XXXII., above. 1897.]

b. Transform to 
$$\frac{d\xi}{dx} + \xi^2 = X,$$

and express this by the help of an auxiliary operation in terms of a merely artificial quantity  $z$ , so that

$$\frac{d\xi}{dx} + \xi^2 = \epsilon^x \frac{d}{dz} Z;$$

and then all equations of the kind considered can be reduced to the very simple form

$$\frac{d\xi}{dx} + \xi^2 = A\epsilon^{ax}.$$

If this were integrated, the only remaining difficulty would lie in the separation of symbols from the quantities they operate upon.



## XXXVI.

ON A POSSIBLE INFLUENCE OF MAGNETISM ON THE  
ABSORPTION OF LIGHT, AND SOME CORRELATED SUBJECTS.

[*Proceedings of the Royal Society of Edinburgh, February 7, 1876.*]

PROFESSOR G. Forbes' paper, read at a late meeting of the Society, and some remarks made upon it by Professor Clerk-Maxwell, have once more recalled to me an experiment which I tried for the first time rather more than twenty years ago, in Queen's College, Belfast. I have since that time tried it again and again, whenever I succeeded in getting improved diamagnetics, a more powerful field of magnetic force, or a more powerful spectroscope. Hitherto it has led to no result, but it cannot yet be said to have been fairly tried. I mention it now because I may thus possibly be enabled to get a medium thoroughly suitable for a proper trial.

The idea is briefly this,—The explanation of Faraday's rotation of the plane of polarization of light by a transparent diamagnetic requires, as shown by Thomson, molecular rotation of the luminiferous medium. The plane polarized ray is broken up, while in the medium, into its circularly-polarized components, one of which rotates with the ether so as to have its period accelerated, the other against it in a retarded period. Now, suppose the medium to absorb one definite wave-length only, then—if the absorption is not interfered with by the magnetic action—the portion absorbed in one ray will be of a shorter, in the other of a longer, period than if there had been no magnetic force; and thus, what was originally a single dark absorption line might become a double line, the components being less dark than the single one.

Other allied forms of experiment connected with this subject were discussed.

## XXXVII.

## FORCE\*.

[*Nature*, September 21, 1876.]

It was not to be expected that at short notice I could produce a lecture which should commend itself to the Association by its novelty or originality. But in science there are things of greater value than even these—namely definiteness and accuracy. In fact without them there could not be any science except the very peculiar smattering which is usually (but I hope erroneously) called “popular.” It is vain to expect that more than the elements of science can ever be made in the true sense of the word popular; but it is the people’s *right* to demand of their teachers that the information given them shall be at least definite and accurate, so far as it goes. And as I think that a teacher of science cannot do a greater *wrong* to his audience than to mystify or confuse them about fundamental principles, so I conceive that wherever there appears to be such confusion it is the *duty* of a scientific man to endeavour by all means in his power to remove it. Recent criticisms of works in which I have had at least a share, have shown me that, even among the particularly well-educated class who write for the higher literary and scientific journals, there is wide-spread ignorance as to some of the most important elementary principles of physics. I have therefore chosen, as the subject of my lecture to-night, a very elementary but much abused and misunderstood term, which meets us at every turn in our study of natural philosophy.

I may at once admit that I have nothing new to tell you, nothing which (had you all been properly taught, whether by books or by lectures) would not have been familiar to all of you. But if one has a right to judge of the general standard of popular scientific knowledge from the statements made in the average newspaper—

\* Evening lecture by Prof. Tait at the Glasgow meeting of the British Association, Sept. 8.

or even from those made in some of the most pretentious among so-called scientific lectures—there can be but few people in this country who have an accurate knowledge of the proper scientific meaning of the little word Force.

We read constantly of the so-called “Physical Forces”—heat, light, electricity, &c.—of the “Correlation of the Physical Forces,” of the “Persistence or Conservation of Force.” To an accurate man of science all this is simply error and confusion, and I have full confidence that the inherent vitality of truth will render the attempt to force such confusion upon the non-scientific public quite as futile as the hopelessly ludicrous endeavour of the *Times* to make us spell the word chemistry with a Y instead of an E. It is true that in matters such as this last a good deal depends (as Sam Weller said) “on the taste and fancy of the speller”—and sometimes even absolute error is of little or no consequence. But it is quite another thing when we deal with the fundamental terms of a science. He who has not exactly caught their meaning, is pretty certain to pass from chronic mistakes to frequent blunders, and cannot possibly acquire a definite knowledge of the subject.

In popular language there is no particular objection to multiple meanings for the same word. The context usually shows exactly which of these is intended—and their existence is one of the most fertile sources of really good puns, such as those of Hood, Hook, or Barham. And there is no reason to object to such phrases as the *force of habit*, the *force of example*, the *force of circumstances*, or the *force of public opinion*. But when we read, as I did last week, in one newspaper, that the “force” of a projectile from the 81-ton gun has at last reached the extraordinary amount of 1,450 feet, in another that the “force” of a ball from the great Armstrong gun, lately made for the Italian government, is expected to average somewhere about 30,000 foot-tons—and in a third that the water in the boiler of the *Thunderer* “would in a second of time generate a ‘force’ sufficient to raise 2,000 tons one foot high”—we see that there must be, somewhere at least, if not everywhere, a most reckless abuse of language. In fact we have come to what ought to be scientific statements, and *there* even the slightest degree of unnecessary vagueness is altogether intolerable.

Perhaps no scientific English word has been so much abused as the word “force.” We hear of “Accelerating Force,” “Moving Force,” “Centrifugal Force,” “Living Force,” “Projectile Force,” “Centripetal Force,” and what not. Yet, as William Hopkins, the greatest of Cambridge teachers, used to tell us—“Force is Force”—*i.e.*, there is but one idea denoted by the word, and all force is of one kind, whether it be due to gravity, magnetism, or electricity. This alone serves to give a preliminary hint that (as I shall presently endeavour to make clear to you) there is probably no such *thing* as force at all! That it is, in fact, merely a convenient expression for a certain “rate.” If anyone should imagine that “3 per cent.” is a sum of money, he will soon be grievously undeceived. “3 per cent.” means nothing more or less than the vulgar fraction  $\frac{3}{100}$ . True, the “*Three Per Cents*” usually means something very substantial—but there the term is not a scientific one. Think for a moment how utterly any one of you, supposed altogether ignorant of shipping, would be puzzled by such a newspaper heading as “*The White Star Line*” or “*The Red Jacket Clipper*.”

No doubt some of our scientific terms approach as near to slang as do these; but we are doing our best to get rid of them.

A good deal of the confusion about Force is due to Leibnitz and some of his associates and followers, who, whatever they may have been as mathematicians, were certainly grossly ignorant of some elementary parts of dynamics, insomuch that Leibnitz himself is known to have considered the fundamental system of the *Principia* to be erroneous, and to have devised another and different system of his own. This fact is carefully kept back now-a-days, but it is a fact, and (as I have just said) has had a great deal to do with the vagueness of the terms for *Force* and *Energy* in some modern languages. In fact, in their modern dress, the *Vis Viva*, *Vis Mortua*, and *Vis Acceleratrix* of that time have, in some of their Protean shapes, hooked themselves like Entozoa into the great majority of our text-books.

Before dealing more definitely with the proper meaning of the word "Force" I must briefly consider how we become acquainted with the physical world, and how consequently it is more than probable that some of our most profound impressions, if uninformed, are completely erroneous and misleading.

In dealing with physical science it is absolutely necessary to keep well in view the all-important principle that—

*Nothing can be learned as to the physical world save by observation and experiment, or by mathematical deductions from data so obtained.*

On such a text, volumes might be written; but they are unnecessary, for the student of physical science feels at each successive stage of his progress more and more profound conviction of its truth. He must receive it, at starting, as the unanimous conclusion of all who have in a legitimate manner made true physical science the subject of their study; and, as he gradually gains knowledge by this—the *only*—method, he will see more and more clearly the absolute impotence of all so-called metaphysics, or *à priori* reasoning, to help him to a single step in advance.

Man has been left entirely to himself as regards the acquirement of physical knowledge. But he has been gifted with various *senses* (without which he could not even know that the physical world exists) and with *reason* to enable him to control and understand their indications.

Reason, unaided by the senses, is totally helpless in such matters. The indications given by the senses, unless interpreted by reason, are utterly unmeaning. But when reason and the senses work harmoniously together, they open to us an absolutely illimitable prospect of mysteries to be explored. This is the test of true science—there is no resting-place—each real advance discloses so much that is new and easily accessible that the investigator has but scant time to co-ordinate and consolidate his knowledge before he has additional materials poured into his store.

To sight without reason, the universe appears to be filled with light—except, of course, in places surrounded by opaque bodies.

Reason, controlling the indications of sense, shows us that the sensation of light is our own property; and that what we understand by brightness, &c., does not exist outside our minds. It shows us also that the sensation of colour is purely subjective, the only difference possible between different so-called rays of light outside the eye being merely in the extent, form, and rapidity of the vibrations of the luminiferous medium.

To hearing, without reason, the air of a busy town seems to be filled with sounds. Reason, interpreting the indications of sense, tells us that if we could SEE the particles of air, we should observe among them simply a comparatively slow agitation of the nature of alternate compressions and dilatations superposed upon their rapid motions among one another. And our classification of sounds as to loudness, pitch, and quality, is merely the subjective correlative of what in the air-particles is objectively the amounts of compression, the rapidity of its alternations, and the greater or less complexity of the alternating motion.

A blow from a stick or a stone produces pain and a bruise; but the motion of the stick or stone before it reached the body is as different from the sensation produced by the blow as is the alternate compression and dilatation of the air from the sensation of sound, or the ethereal wave-motion from the sensation of light.

Hence to speak, as the great majority even of "educated" people do, of what we ordinarily mean by light or sound, as existing outside ourselves, is as absurd as to speak of a swiftly-moving stick or stone as pain. But no inconvenience is occasioned if we announce the intention to use the terms light and sound for the objective phenomena, and to speak of their subjective effects as "luminous impressions" or "noise," as the case may be. In this case there is outside us energy of motion of every kind, but in the mind mere corresponding impressions of brightness and colour, noise or harmony, pain, &c., &c.

As another instance, it is obvious that we must be extremely cautious in our interpretation of the immediate evidence of our own senses as to heat.

Touch, in succession, various objects on the table. A paper-weight, especially if it be metallic, is usually cold to the touch; books, paper, and especially a woollen table-cover, comparatively warm. Test them, however, by means of a *thermometer*, not by the sense of touch, and in all probability you will find little or no difference in what we call their *temperatures*. In fact, any number of bodies of any kind shut up in an inclosure (within which there is no fire or other source of heat) all tend to acquire ultimately the same temperature. Why, then, do some feel cold, others warm to the touch?

The reason is simply this—the sense of touch does *not* inform us directly of temperature, but of *the rate at which our finger gains or loses heat*. As a rule bodies in a room are colder than the hand, and heat always tends to pass from a warmer to a colder body. Of a number of bodies, all equally colder than the hand, that one will seem coldest to the touch which is able *most rapidly* to convey away heat from the hand. The question, therefore, is one of *conduction of heat*. And to assure ourselves that it is so, reverse the process: *let us, in fact, try an experiment,*

though an exceedingly simple one; for the essence of experiment is to modify the circumstances of a physical phenomenon so as to increase its value as a test. Put the paper-weight, the books, and the woollen table-cloth into an oven, and raise them all to one and the same temperature—considerably above that of the hand. The woollen cloth will still be comparatively cool to the touch, while the metal paper-weight may be much too hot to hold. The order of these bodies, as to warm and cold, in the popular sense, is in fact reversed; and this is so because the hand is now *receiving* heat from all the various bodies experimented on, and it receives most rapidly from those bodies which in their previous condition were capable of abstracting heat most rapidly. However it may be in the moral world, in the physical universe the giving and taking powers of one and the same body are strictly correlative and equal.

Thus the direct indications of sense are in general utterly misleading as to the relative temperatures of different bodies.

In a baker's oven, at temperatures far above the boiling point of water (on one occasion even 320° F., so high indeed that a beef-steak was cooked in thirteen minutes), Tillet in France, and Blagden and Chantrey in England, remained for nearly an hour in comparative comfort. But though their clothes gave them no great inconvenience, they could not hold a metallic pencil-case without being severely burned.

On the other hand, great care has to be taken to cover with hemp, or wool, or other badly conducting substance, every piece of metal which has to be handled in the intense cold to which an Arctic expedition is subjected; for contact with very cold metal produces sores almost undistinguishable from burns, though due to a directly opposite cause. Both of these phenomena, however, ultimately depend on the comparative facility with which heat is conducted by metals.

Even from the instance just given, you cannot fail to see that there is a profound distinction between heat and temperature. Heat, whatever it may be, is SOMETHING which can be transferred from one portion of matter to another; the consideration of temperatures is virtually that of the mere CONDITIONS which determine whether or not there shall be a transfer of heat, and in which direction the transfer is to take place. Bear this carefully in mind, because it has most important analogies to the results we meet with in considering the nature of Force.

It has been definitely established by modern science that *heat, though not material, has objective existence in as complete a sense as matter has.*

This may appear, at first sight, paradoxical; but we must remember that so-called paradoxes are merely facts as yet unexplained, and therefore still apparently inconsistent with others already understood in their full significance.

When we say that matter has objective existence, we mean that it is something which exists altogether independently of the senses and brain-processes by which alone we are informed of its presence. An exact or adequate conception of it, if it could be formed, would probably be something very different from any conception which

our senses will ever enable us to form; but the object of all pure physical science is to endeavour to grasp more and more perfectly the nature and laws of the external world, using the imperfect means which are at our command—reason acting as interpreter as well as judge, while the senses are merely more or less untrustworthy and incompetent witnesses, but still of inconceivable value to us because they are our only available ones.

Without further discussion we may state once for all that our conviction of the objective reality of matter is based mainly upon the fact, *discovered solely by experiment*, that we cannot in the slightest degree alter its quantity. We cannot destroy, nor can we produce, even the smallest portion of matter. But reason requires us to be consistent in our logic; and thus, if we find anything else in the physical world whose quantity we cannot alter, we are bound to admit it to have objective reality as truly as matter has, however strongly our senses may predispose us against the concession. Heat therefore, as well as light, sound, electric currents, &c., though not forms of matter, must be looked upon as being as real as matter, simply because they have been found to be forms of energy—which in all its constant mutations satisfies the test which we adopt as conclusive of the reality of matter. We shall find that this test fails when applied to force.

But you must again be most carefully warned to distinguish between heat and the mere sensation of warmth; just as you distinguish between the motion of a cudgel and the pain produced by the blow. The one is the *thing* to be measured, the other is only the more or less imperfect reading or indication given by the instrument with which we attempt to measure it in terms of some one of its effects. So that when your muscular sense impresses on you the notion that you are exerting force as in pushing or pulling, you ought to be very cautious in forming a judgment as to what is really going on; and you ought to demand much farther evidence before admitting the objective reality of force.

Until all physical science is reduced to the deduction of the innumerable mathematical consequences of a few known and simple laws, it will be impossible altogether to avoid some confusion and repetition, whatever be the arrangement of its various parts which we adopt in bringing them before a beginner. But when we confine ourselves to one definite branch of the subject, all of whose fundamental laws can be distinctly formulated, there need be no such confusion. Here in fact the mathematician has it all in his own hands. He is the skilled artificer with his plan and his trowel, and the hodmen have handed up to him all the requisite bricks and mortar.

[Prof. Tait gave a quotation in support of this view.]

Whether there is such a *thing* as force or not I shall consider presently. But in the meanwhile there can be no doubt that it is a convenient term, provided it be employed in one definite sense, and one only. Let us then first see how it is to be correctly used. Here we cannot but consult Newton. The sense in which he uses the word “force,” and therefore the sense in which we must continue to use

it if we desire to avoid intellectual confusion, will appear clearly from a brief consideration of his simple statement of the laws of motion.

The first of these laws is: *Every body continues in its state of rest or of uniform motion in a straight line, except in so far as it is compelled by impressed forces to change that state.*

In other words, any change, whether in the *direction* or in the *rate* of motion of a body is attributed to *force*. Thus a stone let fall moves quicker and quicker, and we say that a force (viz., the weight of the stone, or the earth's attraction for it) is continually acting so as to increase the *rate* of the motion. If the stone be thrown upwards, the *rate* of its motion continually diminishes, and we say that the same force (the stone's weight) is continually acting so as to produce this diminution of speed. So far, none of you probably feels the least difficulty. But we have got only half of the information on this point which Newton's first law affords. You see the moon revolving about the earth, and the earth and other planets revolving about the sun—approximately, at least, in circles. Why is this? Their *directions* of motion are constantly changing; in fact, a curved line is merely a line whose direction changes from point to point, while a straight line is one whose direction does not change; but to produce this change of direction force is required just as much as to produce change of speed. That is supplied by the gravitation attraction of the central body of the system. The old notion was that a centripetal force was required to balance the so-called centrifugal force, it being imagined that a body moving in a circle had a tendency to fly outwards from the centre! Newton's simple law exposes fully the absurdity of this. If a body is to be made to move in a curved line instead of its natural straight path, you must apply force to compel it to do so; certainly not to prevent it from flying outwards from the centre, about which it is for the moment revolving. In fact, inertia means, not revolutionary activity, but dogged perseverance, and just as you must apply force *in* the direction of motion to change the *rate* of motion, so must you apply force *perpendicular* to the direction of motion to change that *direction*.

Newton's second law is now required: *Change of motion is proportional to the impressed force, and takes place in the direction of the straight line in which the force acts.*

Mark here most carefully that this one simple law holds for *all* kinds of force alike. There is no special law for gravitation-force and others for electric and magnetic forces. All are defined alike, without reference to their origin.

Motion, as Newton has previously defined it, is here used as a technical scientific term for what we now call *momentum*. It is the product of the mass moving into the velocity with which it moves. "Change of motion," therefore, is change of momentum, or the product of the mass of the moving body into its change of velocity. Now a change of velocity is itself a velocity, as we see by the science of mere motion—kinematics—the purely mathematical science of mixed space and time.



Newton's words, however, imply more than this. Of course, the longer a given force acts, the greater will be the change of momentum which it produces; so that to compare forces, which is the essence of the process of measuring them, we must give them equal times to act—or, in scientific language, we must measure a force by the *rate* at which it produces change of momentum. Rate of change of velocity is called in kinematics acceleration. Thus the measure of a force is the product of the mass of the body moved into the acceleration which the force produces in it. This is the so-called *Vis motrix*, or "moving force" of the Cambridge text-books:—the so-called *Vis acceleratrix*, or "accelerating force," being really no force at all, but another name for the kinematical quantity acceleration which I have just defined.

Unit force is thus that force which, *whatever be its source*, produces unit momentum in unit of time. If we employ British units—unit of force is that which, in one second, gives to one pound of matter a velocity of one foot per second. Here you must carefully notice that a *pound* of matter is a certain *mass* or quantity of matter. When you buy a pound of tea, you buy a quantity of the matter called tea, equal in *mass* to the standard pound of platinum. The idea of weight does not enter primarily into the process. In fact, the use of an ordinary balance depends upon one clause of Newton's law of gravitation—which tells us that in any locality whatever, the weights of bodies are equal if their masses are equal. The weight of a pound of matter varies from place to place on the earth's surface—it depends on the attracting as well as the attracted body. The mass of a body is its own property. The earth's attraction for a body, or the weight of the body, is a force which produces in it in one second, a velocity which (in this latitude, and at the sea-level) is about 32·2 feet per second. So that, in Glasgow the weight of a pound—which we take as our standard of mass—is rather more than thirty-two units of force, or, what comes to the same thing, the British unit of force is about the former weight of a penny letter—half an ounce.

Some people are in the habit of confounding force with momentum. No one having sound ideas of even elementary mathematics could be guilty of this or any similar monstrosity. He would as soon, as Hopkins used to say, measure heights in acres, or arable land in cubic miles. But to show to a non-mathematician that it is really monstrous to confound force and momentum, it suffices to change the system of units employed in measuring them, when it will be found that, if numerically equal for any one system of units, they are necessarily rendered unequal by a mere change of the unit employed for time. Now two things which are really equal to one another must necessarily be expressed by the same numerical quantity *whatever* system of units be adopted. Let us try then unit of force and unit of momentum, as defined by pound, foot, second, units: and see what alterations a common change of these fundamental units will make in their numerical expression.

Unit momentum is that of one pound of matter moving with a velocity of one foot per second. Unit force is that force which, acting for one second, produces in unit of mass a velocity of one foot per second. In each of these statements you may put an ounce or a ton, instead of a pound, and an inch or a mile in place of a foot, and their relative value will not be altered. But suppose we take a

minute instead of a second as the unit of time. One foot per second is sixty feet per minute—so this change of the time unit increases sixty-fold the nominal value of the momentum considered. But in the case of the force our statement would stand thus:—What we formerly called unit of force is that which, acting for one-sixtieth only of our new unit of time produces in a mass of one pound, sixty-fold the new unit of velocity. In other words the number expressing the momentum is increased sixty-fold, while that representing the force is increased three thousand six hundred fold.

In fact, whatever be the system of units you employ—if you increase in any proportion the unit of time, the measure of a momentum is increased, in that proportion simply, while that of a force is increased in the duplicate ratio. The two things are, therefore, of quite dissimilar nature, and cannot lawfully be equated to one another under any circumstances whatever.

The mathematician expresses this distinction at once by saying that momentum is the time-integral of force, because force is the rate of change of momentum.

But what I have already said as to the meaning of Newton's two first laws leaves absolutely no doubt as to the only definite and correct meaning of the word force. It is obviously to be applied to any pull, push, pressure, tension, attraction, or repulsion, &c., whether applied by a stick or a string, a chain or a girder; or by means of an invisible medium such as that whose existence is made certain by the phenomena of light and radiant heat, and which has been shown with great probability to be capable of explaining the phenomena of electricity and magnetism.

I have already mentioned to you that the notion of force is suggested to us by the so-called muscular sense, which gives us a peculiar feeling of pressure when we attempt to move a piece of matter. To get a notion of what it really means we must again have recourse to physical facts instead of the uncontrolled evidence of the senses. Almost all that is required for this purpose is summed up for us in the remaining law of motion. Before we take it up, however, let us briefly consider the position at which we have arrived.

We have seen how to get rid of two gratuitous absurdities—the so-called centrifugal force and accelerating force, and we must proceed to exterminate living force. Cormoran and Blunderbore have been disposed of, but a more dangerous giant remains. More dangerous because he is a reality, not a phantom like the other two. Whatever force may be, there is no such thing as centrifugal force; and accelerating force is not a physical idea at all. But that which is denoted by the term living force, though it has absolutely no right to be called force, is something as real as matter itself. To understand its nature we must have recourse to another quotation from the *Principia*.

Newton's third law of motion is to the effect that—

*“To every action there is always an equal and contrary reaction; or, the mutual actions of any two bodies are always equal and oppositely directed.”*

This law Newton first shows to hold for ordinary pressures, tensions, attractions, impacts, &c., that is for *forces* exerted on one another by two bodies, or their time-integrals. And when he says—"If any one presses a stone with his finger his finger is pressed with an equal and opposite force by the stone," we begin to suspect that force is a mere name—a convenient abstraction—not an objective reality.

Pull one end of a long rope, the other being fixed. You can produce a practically *infinite* amount of force, for there is stress across every section throughout the whole length of the rope. Press upon a movable piston in the side of a vessel full of liquid. You produce a practically infinite amount of force—for across every ideal section of the liquid a pressure per square inch is produced equal to that which you applied to the piston. Let go the rope, or cease to press on the piston, and all this practically infinite amount of force is gone!

The only man who, to my knowledge, ever tried to discover experimentally what might be correctly called *conservation of force*, was Faraday. He was not satisfied with the mode of statement of Newton's law of gravitation, in which the mutual attraction between two bodies is said to VARY inversely as the square of their distance from one another. When the distance between two bodies is doubled, their mutual attraction falls off to one-fourth of what it formerly was. Faraday seriously set to work to determine what became of the three-fourths which have disappeared, but all his skill was insufficient to give him any result. Faraday's insight was so profound that we cannot assert that something may not yet be discovered by such experiments, but it will assuredly not be a conservation of force.

But Newton proceeds to point out that this third law is true in another and much higher sense. He says:—

*"If the action of an agent be measured by the product of its force into its velocity; and if, similarly, the reaction of the resistance be measured by the velocities of its several parts into their forces, whether these arise from friction, cohesion, weight, or acceleration, action and reaction, in all combinations of machines, will be equal and opposite."*

The actions and reactions which are here stated to be equal and opposite, are no longer simple forces, but the *products* of forces into their velocities; *i.e.*, they are what are now called *rates of doing work*; the time-rate of increase, or the increase per second of a very tangible and real SOMETHING, for the measurement of which rate Watt introduced the practical unit of a *horse-power*, or the rate at which an agent works when it lifts 33,000 pounds 1 foot high per minute against the earth's attraction.

Now think of the difference between raising a hundredweight and endeavouring to raise a ton. With a moderate exertion you can raise the hundredweight a few feet, and in its descent it might be employed to drive machinery, or to do some other species of work. But tug as you please at the ton, you will not be able to lift it; and therefore, after all your exertion, it will not be capable of doing any work by descending again.

Thus it appears that *force* is a mere name, and that the *product of a force into the displacement of its point of application* has an objective existence. In fact, modern science shows us that force is merely a convenient term employed for the present (very usefully) to shorten what would otherwise be cumbrous expressions; but it is not to be regarded as a *thing*, any more than the bank *rate of interest* (be it 2, 2½, or 3 per cent.) is to be looked upon as a sum of money, or than the birth-rate of a country is to be looked upon as the actual group of children born in a year. Another excellent instance is to be had from the rainfall. We say rain fell on such a day at the rate of an inch in twenty-four hours. What *can* be an inch of rain? especially when we mean a *linear*, not a *cubic* inch. But there is no confusion or absurdity here. What is implied is that, if it had gone on raining at that rate for twenty-four hours, and if the rain (like snow) remained where it fell, the ground would have been coated to the depth of an inch.

In fact, a simple mathematical operation shows us that it is precisely the same thing to say:—

*The horse-power of an agent, or the amount of work done by an agent in each second, is the product of the force into the average velocity of the agent,*

and to say—

*Force is the rate at which an agent does work per unit of length.*

In the special illustration of Newton's words which I have just given, the resistance was a *weight*, that of a hundredweight or of a ton. When the resistance was overcome, work was done, and it was stored up for use in the raised mass—in a form which could be made use of at any future time.

Following a hint given by Young, we now employ the term ENERGY to signify the power of doing work, in *whatever* that power may consist. The raised mass, then, we say possesses, in virtue of its elevation, an amount of energy precisely equal to the work spent in raising it. This dormant, or passive, form is called *potential* energy. Excellent instances of potential energy are supplied by water at a high level, or with a "head," as it is technically called, in virtue of which it can in its descent drive machinery; by the wound-up "weights" of a clock, which in their descent keep it going for a week; by gunpowder, the chemical affinities of whose constituents are called into play by a spark; &c., &c.

Another example of it is suggested by the word "cohesion," employed in Newton's statement, which must obviously be taken to include what are called molecular forces in general, such as, for instance, those upon which the elasticity of a solid depends.

When we draw a bow, we do work, because the force exerted has a velocity; but the drawn bow (like the raised weight) has in potential energy the equivalent of the work so spent. That can in turn be expended upon the arrow; and *what then?*

Turn, again, to Newton's words, and we see that he speaks of one of the forms of resistance as arising from "acceleration." In fact the arrow, by its inertia, resists being

set in motion; work has to be spent in propelling it, but the moving arrow has that work in store in virtue of its motion. It appears from Newton's previous statements that the measure of the rate at which work is spent in producing acceleration is *the product of the momentum into the acceleration in the direction of motion*, and the energy produced is measured by *half the product of the mass into the square of the velocity produced in it*. This active form is called *kinetic energy*, and it is the double of this to which the term *vis viva*, or *living force*, has been erroneously applied.

As instances of ordinary kinetic energy, or of mixed kinetic and potential energies, take the following:—A current of water capable of driving an undershot wheel; winds, which also are used for driving machinery; the energy of water-waves or of sound waves; the radiant energy which comes to us from the sun, whether it affect our nerves of touch or of sight (and therefore be called radiant heat or light) or produce chemical decomposition, as of carbonic acid and water in the leaves of plants, or of silver salts in photography (and be therefore called actinism); the energy of motion of the particles of a gas, upon which its pressure depends, &c. [When the motion is vibratory the energy is generally half potential, half kinetic.]

These explanations and definitions being premised, we can now translate Newton's words (without alteration of their meaning) into the language of modern science, as follows:—

*Work done on any system of bodies (in Newton's statement the parts of any machine) has its equivalent in work done against friction, molecular forces, or gravity, if there be no acceleration; but if there be acceleration, part of the work is expended in overcoming the resistance to acceleration, and the additional kinetic energy developed is equivalent to the work so spent.*

But we have just seen that when work is spent against molecular forces, as in drawing a bow or winding up a spring, it is stored up as potential energy. Also it is stored up in a similar form when done against gravity, as in raising a weight.

Hence it appears that, according to Newton, whenever work is spent it is stored up either as potential or as kinetic energy, except, possibly, in the case of work done against friction, about whose fate he gives us no information. Thus Newton expressly tells us that (except, possibly, when there is friction) *work is indestructible*, it is changed from one form of energy to another, and so on, but never altered in quantity. To make this beautiful statement complete, all that is requisite is to know *what becomes of work spent against friction*.

Here, of course, experiment is requisite. Newton, unfortunately, seems to have forgotten that savage men had long since been in the habit of making it whenever they wished to procure fire. The patient rubbing of two dry sticks together, or (still better) the drilling of a soft piece of wood with the slightly blunted point of a hard piece, is known to all tribes of savages as a means of setting both pieces of wood on fire. Here, then, heat is undoubtedly produced, *but it is produced by the expenditure of work*. In fact work done against friction has its equivalent in the heat produced.

This Newton failed to see, and thus his grand generalisation was left, though on one point only, incomplete. The converse transformation, that of heat into work, dates back to the time of Hero at least. But the knowledge that a certain process will produce a certain result does not necessarily imply even a notion of the "why"; and Hero as little imagined that in his æolipile heat was *converted into work*, as do savages that work can be *converted into heat*.

But whenever any such conversion or transference takes place there is necessarily motion: and the mere rate of conversion or transference of energy per unit length of that motion is, in the present state of science, very conveniently called force. No confusion can arise from using such a word in such a sense. On the contrary, there is always a gain in clearness when compactness can lawfully be introduced.

Rumford and Davy, at the very end of last century, by totally different experimental processes, showed conclusively that the materiality of heat could not be maintained, and thus gave the means of completing Newton's statement which, still farther extended and generalised rather more than thirty years ago by the magnificent experimental work of Colding and Joule, now stands as one massive pillar of the fast-rising temple of science:—known as the law of the *conservation of energy*.

The conception of kinetic energy is a very simple one, at least when visible motion alone is involved. And from motion of visible masses to those motions of the particles of bodies whose energy we call heat, is by no means a very difficult mental transition. Mark, however, that heat is not the mere motions but the energy of these motions; a very different thing, for heat and kinetic energy in general are no more "*modes of motion*" than potential energy of every kind (including that of unfired gunpowder) is a "*mode of rest!*" In fact a "*mode of motion*" is, if the word motion be used in its ordinary sense, purely kinematical, not physical; and if motion be used in Newton's sense, it refers to momentum, not to energy.

The conception of potential energy, however, is not by any means so easy or direct. In fact, the apparently direct testimony of our muscular sense to the existence of force makes it at first much easier for us to conceive of force than of potential energy. *Why* two masses of matter possess potential energy when separated—in virtue of which they are conveniently said to attract one another—is still one of the most obscure problems in physics. I have not now time to enter on a discussion of the very ingenious idea of the ultramundane corpuscles, the outcome of the life-work of Le Sage, and the only even apparently hopeful attempt which has yet been made to explain the mechanism of gravitation. The most remarkable thing about it is that, if it be true, it will probably lead us to regard all kinds of energy as ultimately kinetic.

And a singular quasi-metaphysical argument may be raised on this point, of which I can give only the barest outline. The mutual convertibility of kinetic and potential energy shows that relations of equality (though not necessarily of identity) can exist between the two, and thus that their proper expressions involve the same fundamental units, and in the same way. Thus, as we have already seen that kinetic energy involves the unit of mass and the square of the linear unit directly, together with

the square of the time unit inversely, the same must be the case with potential energy; and it seems very singular that potential energy should thus essentially involve the unit of time if it do not ultimately depend in some way on energy of motion.

[Prof. Tait then gave instances of the inaccurate use of the word Force.]

To conclude—In defence of accuracy, which is the *sine quâ non* of all science, we must be “zealous,” as it were, even to “slaying.” And, as all the power of the *Times* will not compel us to put a *y* instead of an *e* into the word chemist, so neither will the bad example of Germany and France, though recommended to us with all the authority which may be attributed to an ex-president of this Association, succeed in inducing us to attach two or more perfectly distinct and incompatible scientific meanings to that useful little word, “force,” which Newton has once and for ever defined for us with his transcendent clearness of conception.

I have now only to ask your indulgence for the crudeness of this lecture. All I can say is that in preparing it, I have done my best, under circumstances of time, place, and surroundings, all alike unpropitious. But the chance of being able to back up, however imperfectly, my old friend, Dr Andrews, in whose laboratory I first learned properly to use scientific apparatus, and whose sage counsel impressed upon me the paramount importance of scientific accuracy, and above all, of scientific honesty—such a chance was one which no surroundings (however unpropitious) could have induced me to forego.

## XXXVIII.

## SOME ELEMENTARY PROPERTIES OF CLOSED PLANE CURVES\*.

[*Messenger of Mathematics*, New Series, No. 69, 1877.]

THE closed curves contemplated are supposed to have nothing higher than *double* points. By infinitesimal changes of position of the branches intersecting in it, a triple point is decomposable into 3 double points, a quadruple point into 6, and generally an  $x$ -ple point into  $\frac{x(x-1)}{1.2}$  double points.

I. A closed curve cuts any infinite unknotted line in an even number of points. [Infinite here implies merely that both ends are outside the closed curve.]

For, if it be broken anywhere, as at  $A$  (fig. 1), both free ends are on the same side of the infinite line.

II. The same is true if the infinite line be knotted.

For, as there is nothing higher than a double point, the knotted line may be opened up into an unknotted one (as in fig. 2) without changing the circumstances.

It is an interesting problem to find the number of such modes of opening a given knot. An extension of this problem leads to the question of the number of essentially distinct ways in which a closed curve may be broken up into separate closed curves, knotted or unknotted (fig. 3).

III. If any two closed curves cut one another, there is an even number of points of intersection.

\* Communicated to Section A, at the 1876 Meeting of the British Association.



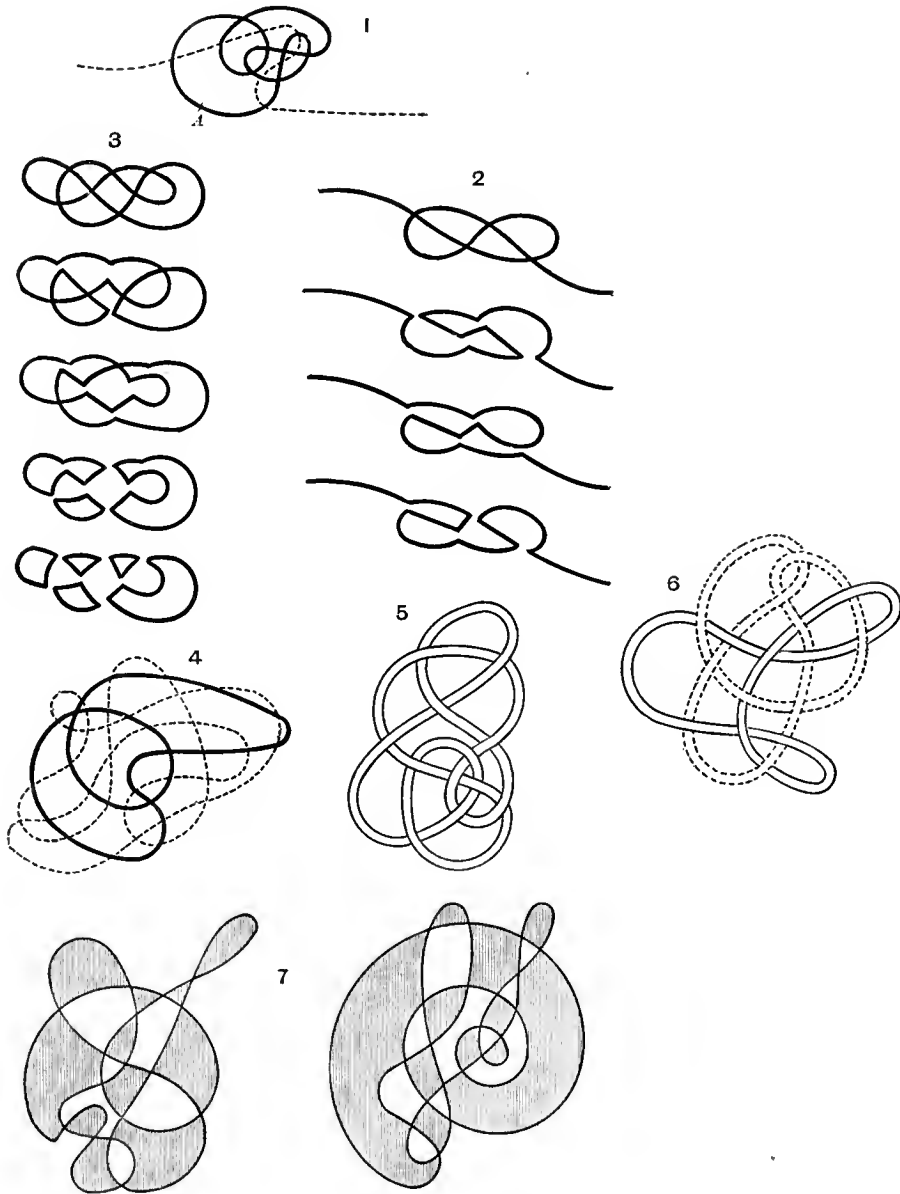

For there must be points of one of them at least in the outer boundary of the complex figure. Open it at such a point, and the line becomes infinite in the sense of I. above (fig. 4).

IV. In going continuously along a closed curve from a point of intersection to the same point again an even number of intersections is passed.

For (a) If the partial path cross itself, it must pass twice through each such intersection.

(b) As regards the rest, the two parts may be considered to be separate closed curves as in III.

V. Hence, in going round such a closed curve we may go alternately above and below the branches as we meet them (fig. 5). Strictly speaking, we have only now arrived at *Knots*; and, in what precedes, we ought to read 'autotomic' for 'knotted.'

VI. By III. the same proposition is true of a complex arrangement of any number of separate closed curves superposed in any manner (fig. 6).

VII. In passing from the interior of any one cell to that of any other—in any system of superposed closed curves—the number of crossings is always even or always odd, whatever path be taken.

For any path from the exterior, through each of these cells to the exterior again, has an even number of crossings. Varying only the part of this path between the two cells, it must have always an even or an odd number of crossings.

VIII. Hence, the cells may be coloured black and white in such a way that from white to white there is always an even number of crossings, and from white to black an odd number. Such closed curves therefore divide the plane as nodal lines do a vibrating plate (fig. 7).

The development of this subject promises absolutely endless work—but work of a very interesting and useful kind—because it is intimately connected with the theory of knots, which (especially as applied in Sir W. Thomson's *Theory of Vortex Atoms*) is likely soon to become an important branch of mathematics.

## XXXIX.

## ON KNOTS.

[*Transactions of the Royal Society of Edinburgh*, 1876-7. Revised May 11, 1877.]

THE following paper contains, in a compact form, the substance of several somewhat bulky communications laid before the Society during the present session. The gist of each of these separate papers will be easily seen from the abstracts given in the Proceedings. These contain, in fact, many things which I have not reproduced in this digest. Nothing of any importance has been added since the papers were read, but the contents have been very much simplified by the adoption of a different order of arrangement; and long passages of the earlier papers have been displaced in favour of short general statements from the later ones. With the exception of the portion which deals with the main question raised, this paper is fragmentary in the extreme. Want of leisure or press of other work may justly be pleaded as one cause; but there is more than that. The subject is a very much more difficult and intricate one than at first sight one is inclined to think, and I feel that I have not succeeded in catching the key-note. When that is found, the various results here given will no doubt appear in their real connection with one another, perhaps even as immediate consequences of a thoroughly adequate conception of the question.

I was led to the consideration of the forms of knots by Sir W. Thomson's Theory of Vortex Atoms, and consequently the point of view which, at least at first, I adopted was that of classifying knots by the number of their crossings; or, what comes to the same thing, *the investigation of the essentially different modes of joining points in a plane, so as to form single closed plane curves with a given number of double points.*

The enormous numbers of lines in the spectra of certain elementary substances show that, if Thomson's suggestion be correct, the form of the corresponding vortex

atoms cannot be regarded as very simple. For though there is, of course, an infinite number of possible modes of vibration for every vortex, the number of modes whose period is within a few octaves of the fundamental mode is small unless the form of the atom be very complex. Hence the difficulty, which may be stated as follows (assuming, of course, that the visible rays emitted by a vortex atom belong to the graver periods):—"What has become of all the simpler vortex atoms?" or "Why have we not a much greater number of elements than those already known to us?" It will be allowed that, from the point of view of the vortex-atom theory, this is almost a vital question.

Two considerations help us to an answer. *First*, however many simpler forms may be geometrically possible, only a very few of these may be forms of kinetic stability, and thus to get the sixty or seventy permanent forms required for the known elements, we may have to go to a very high order of complexity. This leads to a physical question of excessive difficulty. Thomson has briefly treated the subject in his recent paper on "Vortex Statics\*," but he cannot be said to have as yet even crossed the threshold. But *secondly*, stable or not, are there after all very many different forms of knots with any given small number of crossings? This is the main question treated in the following paper, and it seems, so far as I can ascertain, to be an entirely novel one.

When I commenced my investigations I was altogether unaware that anything had been written (from a scientific point of view) about knots. No one in Section A at the British Association of 1876, when I read a little paper (No. XXXVIII. above) on the subject, could give me any reference; and it was not till after I had sent my second paper to this Society that I obtained, in consequence of a hint from Professor Clerk-Maxwell, a copy of the very remarkable Essay by Listing, *Vorstudien zur Topologie*†, of which (so far as it bears upon my present subject) I have given a full abstract in the Proceedings of the Society for Feb. 3, 1877. Here, as was to be expected, I found many of my results anticipated, but I also obtained one or two hints which, though of the briefest, have since been very useful to me. Listing does not enter upon the determination of the number of distinct forms of knots with a given number of intersections, in fact he gives only a very few forms as examples, and they are curiously enough confined to three, five, and seven crossings only; but he makes several very suggestive remarks about the representation of knots in general, and gives a special notation for the representation of a particular class of "reduced" knots. Though this has absolutely no resemblance to the notation employed by me for the purpose of finding the number of distinct forms of knots, I have found a slight modification of it to be very useful for various purposes of illustration and transformation. This work of Listing's, and an acute remark made by Gauss (which, with some comments on it by Clerk-Maxwell, will be referred to later), seem to be all of any consequence that has been as yet written on the subject. I have acknowledged in the text all the hints I have got from these writers; and the abstract of Listing's work above referred to will show wherein he has anticipated me.

\* *Proc. R.S.E.* 1875—6 (p. 59).

† *Göttinger Studien*, 1847.

## PART I.

*The Scheme of a Knot, and the number of distinct Schemes for each degree of Knottiness.*

§ 1. My investigations commenced with a recognition of the fact that in any knot or linkage whatever the crossings may be taken throughout alternately over and under. It has been pointed out to me that this seems to have been long known, if we may judge from the ornaments on various Celtic sculptured stones, &c. It was probably suggested by the processes of weaving or plaiting. I am indebted to Mr Dallas for a photograph of a remarkable engraving by Dürer, exhibiting a very complex but symmetrical linkage, in which this alternation is maintained throughout. Formal proofs of the truth of this and some associated properties of knots will be found in the little paper already referred to\*. They are direct consequences of the obvious fact that two closed curves in one plane necessarily intersect one another an *even* number of times. It follows as an immediate deduction from this that in going continuously round any closed plane curve whatever, an even number of intersections is always passed on the way from any one intersection to the same again. Hence, of course, if we agree to make a knot of it, and take the crossings (which now correspond to the intersections) over and under alternately, when we come back to any particular crossing we shall have to go *under* if we previously went *over*, and *vice versâ*. This is virtually the foundation of all that follows.

But it is essential to remark that we have thus two alternatives for the crossing with which we start. We may make the branch we begin with cross *under* instead of *over* the other at that crossing. This has the effect of changing any given knot into its own image in a plane mirror—what Listing calls *Perversion*. Unless the form be an *Amphicheiral* one (a term which will be explained later), this perversion makes an essential difference in its character—makes it, in fact, a different knot, incapable of being deformed into its original shape.

Listing speaks of crossings as *dextrotrop* or *laetotrop*. If we think of the edges of a flat tape or india-rubber band twisted about its mesial line, we recognise at once the difference between a right and a left handed crossing. (Plate IV. fig. 1.) Thus the acute angles in the following figure are left handed, the obtuse, right handed; and they retain these characters if the figure be turned over (*i.e.*, about an axis in the plane of the paper):—

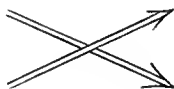

but in its image in a plane mirror these characters are interchanged.

\* No. XXXVIII. above.

§ 2. Suppose now a knot of any form whatever to be projected as a shadow cast by a luminous point on a plane. The projection will always necessarily have double points\*, and in general the number of these may be increased—though not always diminished—by a change of position of the luminous point, or by a distortion of the wire or cord, which we may suppose to form the knot. This wire or cord must be supposed capable of being bent, extended, or contracted to any amount whatever, subject to the *sole* condition that no lap of it can be pulled through another, *i.e.*, that its continuity cannot be interrupted. There are, therefore, projections of every knot which give a *minimum* number of intersections, and it is to these that our attention must mainly be confined. Later we will consider the question how to determine this minimum number, which we will call *Knottiness*, for any particular knot; but for our present purpose it is sufficient to get rid of what are *necessarily* nugatory intersections, *i.e.*, intersections which no alteration of the mode of crossing can render permanent. These crossings are essentially such that if both branches of the string were cut across at one of them, and their ends reunited crosswise, so as to form two separate closed curves, these separate curves shall not be linked together, however they may individually be knotted, *i.e.*, that if they are knots they are separate from one another, so that one of them may be drawn tight so as to present only a roughness in the string. For in this case the nugatory crossing will thus be made to bound a mere *loop*.

[We may define a necessarily nugatory crossing as one through which a closed, or an infinitely extended, surface may pass without meeting the string anywhere but at the crossing. Or, as will be seen later (§ 20), we may recognise a necessarily nugatory crossing as a point *where a compartment meets itself*.]

In the first two of the sketches subjoined all the crossings are necessarily nugatory; in the third, only the middle one is so.

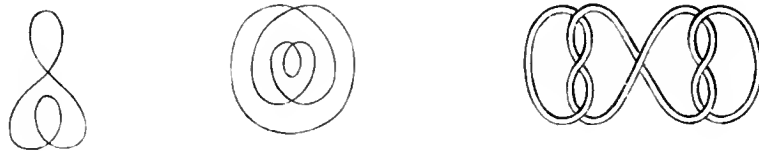

Now these diagrams, when lettered in the manner forthwith to be explained (see, for instance, Plate V. fig. 1), present respectively the following *schemes* :—

AABB | A

ACBBCA | A

ACBDCBDAEGFEGF | A.

\* Higher multiple points may, of course, occur, but an *infinitesimal* change of position of the luminous point, or of the relative dimensions of the coils of the knot, will remove these by splitting them into a number of double points, so that we need not consider them.

These and similar examples show that in a scheme a crossing is necessarily nugatory, if between the two appearances of the letter denoting that crossing there is a group consisting of any set of letters *each occurring twice*. The set may consist of any number whatever, including zero. For our present purpose it will be found sufficient to consider this last special case alone, *i.e.*, *the same letter twice in succession denotes a necessarily nugatory crossing*.

§ 3. If we affix letters to the various crossings, and, going continuously round the curve, write down the name of each crossing in the order in which we reach it, we have, as will be proved later, the means of drawing without ambiguity the projection of the knot. If, in addition, we are told whether we passed over or under on each occasion of reaching a crossing we can, again without any ambiguity, construct the knot in wire or cord. Passing over is, in what follows, indicated by a + subscribed to the letter denoting the crossing—passing under by a -. Any specification which includes these two pieces of information is necessarily *fully descriptive* of the knot; and when it is given in the particular form now to be explained we shall call it the *Scheme*.

If in accordance with § 1 we make the crossings alternately over and under, it is obvious that the odd places and even places of the scheme will each contain all the crossings. As the choice of letters is at our disposal, we may therefore call the crossings in the odd places A, B, C, &c., in alphabetical order, starting from any crossing we please, and going round the knotted wire in any of the four possible ways, *i.e.*, starting from any crossing by any of the four paths which lead from it, put the successive letters at the first, third, fifth, &c., crossings as we meet them. Then it is obvious that the essential character of the projected knot must depend only upon *the way in which the letters are arranged in the even places of the scheme*. Of course, the nature and reducibility (*i.e.*, capability of being simplified by the removal of nugatory crossings) of the knot itself depend also upon the subscribed signs. [In general there will be four different schemes for any one knot, but in the simpler cases these are often identical, two and two, sometimes all four.]

§ 4. Here we may remark that it is obvious that when the crossings are alternately + and - no reduction is possible, unless there be essentially nugatory crossings, as explained in § 2. For the only way of getting rid of such alternations of + and - along the same cord is by *untwisting*; and this process, except in the essentially nugatory cases, gets rid of a crossing at one place only by introducing it at another. It will be seen later that this process may in certain cases be employed *to change the scheme* of a knot, and thus to show that in these cases there may be more than four different schemes representing the same knot; though, as we have already seen, a scheme is perfectly definite as to the knot it represents. Hence, in the first part of our work, we shall suppose that the crossings are taken alternately + and -, so that no reduction is possible. But it will afterwards be shown that, even when all essentially nugatory crossings are removed, it is not always necessary to have the regular alternation of + and - in order that the knot may not be farther reducible. It is easy

to see a reason for this, if we think of a knot made up of different knots on the same string, whether separate from one another or linked together. For the irreducibility of each separate knot depends only upon the alternations of + and - *in itself*, and the two knots may be put together, so that this condition is satisfied in the partial schemes, but not in the whole. As there cannot be a knot with fewer than three crossings, we do not meet with this difficulty till we come to knots with six crossings. And as there can be no linking without at least two crossings, we do not meet with linked knots on the same string till we come to eight crossings at least.

§ 5. We are now prepared to attack our main question.

*Given the number of its double points, to find all the essentially different forms which a closed curve can assume.*

Going round the curve continuously, call the first, third, &c., intersections A, B, C, &c. In this category we evidently exhaust all the intersections. The complete scheme is then to be formed by properly interpolating the same letters in the even places; and the form of the curve depends solely upon the way in which this is done.

It cannot, however, be done at random. For, *first*, neither A nor B can occur in the second place, B nor C in the fourth, and so on, else we should have necessarily nugatory intersections, as shown in § 2. Thus the number of possible arrangements of  $n$  letters (viz.,  $n.n-1...2.1$ ) is immensely greater than the number which need here be tried. But, *secondly*, even when this is attended to, the scheme may be an impossible one. Thus, the scheme

$$A D B E C A D B E C | A$$

is lawful, but

$$A D B A C E D C E B | A$$

is not.

The former, in fact, may be treated as the result of superposing two closed (and not self-intersecting) curves, both denoted by the letters A D B E C A, so as to make them cross one another at the points marked B, C, D, E, then cutting them open at A, and joining the free ends so as to make a continuous circuit with a crossing at A.

But in the latter scheme above we have to deal with the curves A D B A and C E C E, and in the last of these we cannot have junctions alternately + and - as required by our fundamental principle. In fact, the scheme would require the point C to lie simultaneously inside and outside the closed circuit A D B A.

Or we may treat A D B A and C E D C as closed curves intersecting one another and yet having only one point, D, in common.

Thus, to test any arrangement, we may strike out from the whole scheme all the letters of any one closed part as A—A, and the remaining letters must satisfy the fundamental principle, *i.e.*, that they can be taken with suffixes + and - alternately, or



(what comes to the same thing) that an even number of letters intervenes between the two appearances of each of the remaining letters.

Or we may strike out all the letters of any two sets which begin and end similarly, *e.g.*,  $A\dots X$ ,  $X\dots A$ , the two together being treated as one closed curve, and the test must still apply.

More generally, we may take the sides of any closed polygon as  $A-X$ ,  $X-Y$ ,  $Y-Z$ ,  $Z-A$ , and apply them in the same way. But in this, as in the simpler case just given, the sides must all be taken the same way round in the scheme itself.

A simple mode of applying these tests will be given later, when we are dealing with the question of *Beknottedness*.

It may be well to explain here how a change of the crossing selected as the initial one alters the scheme. Take the simple case of making  $B$  the first, and reckoning on from it. Then  $B$  becomes  $A$ , &c., and the scheme, which may be any whatever, suppose for example

$$A F B L C E D H \dots$$

becomes (by writing for each letter that which alphabetically precedes it)

$$N E A K B D C G \dots$$

or beginning with  $A$ ,

$$A K B D C G \dots$$

Hence the letters

$$F, L, E, H, \dots$$

in the even places of a scheme are equivalent to

$$K, D, G, \dots E,$$

*i.e.*, we may change each to the preceding letter taken in the cyclical order of the alphabet and put the first to the end, or *vice versa*, without altering the scheme. An arrangement of this kind is *unique* (reproducing itself) if the letters are in cyclical order; and if the number of letters be a prime, any arrangement is either unique or is reproduced after a number of operations of this kind equal to the number of letters. If it be not prime, arrangements may be found which will reproduce themselves after a number of operations equal to any one of its aliquot parts.

Another lawful change is this:—Begin from the  $A$  in the even places and letter as usual, *i.e.*, start from the same crossing as before, and in the same direction round the curve, but not by the same branch of the cord or wire. This will be evident from an example. Beginning at the second  $A$ , and lettering alphabetically every second crossing, we have the suffixed letters,

$$\begin{array}{cccccccc} A & D & B & A & C & F & D & B & E & C & F & E & | & A \\ & & & & & & & & & & & & & & F & A & B & C & D & E \end{array}$$

Now write the same equivalents for the same letters in the odd places, and the scheme in its new lettering is

$$A F C A D B F C E D B E | A$$

or the following are equivalents in the even places

D A F B C E  
D F E B A C,

and each of these has, of course, five other equivalents found by the first of these two processes.

But we may also start from the same intersection A by either of these paths, but *in the reverse direction round the curve*. To effect this we have only to read the scheme backwards, beginning at either A, and changing the lettering throughout in accordance with our plan. Thus, taking the last example,

A D B A C F D B E C F E | A  
F E D C B | A

we keep the terminal A unchanged, and write B, C, &c., for the 2nd, 4th, &c., *preceding* letters. We have thus, as it were, the key for translating from the upper line to the lower. Apply this key to all the letters, and then write the result in the reverse order. Thus we get

A C B E C F D B E A F D | A.

This new scheme has for its even places

C E F B A D

which is equivalent (in this particular case) to the *second* of the two direct schemes just given, viz. :—

D F E B A C.

Finally, if we read this reversed scheme from the A in the even places, its even letters become

E A F C B D

which (in this case) is the same as

D A F B C E

the even letters of the original scheme.

The notation we shall employ is this—*do*, *de*, *ro*, *re*, signifying the even places of the four cases

*d o* the *direct* scheme, read from A in the *odd* place  
*d e* the *direct* scheme, read from A in the *even* place  
*r o* the *reversed* scheme, read from A in the *odd* place  
*r e* the *reversed* scheme, read from A in the *even* place

and we shall denote by an appended numeral the number of times the operation above has to be performed. Thus, in the example just given it will be found that

$r o = d e 2$   
 $r e = d o 2.$

§ 6. With one intersection or two only, a *knot* is thus impossible, for the crossings must necessarily be nugatory. Hence we commence with *three*. And here there is but one case, for by our rule we must write A, B, C in the odd places, and *we have no choice* as to what to interpolate in the even ones. Thus the only knot with three intersections has the scheme

$$A C B A C B | A.$$

One of its two projections is the "trefoil" knot below.

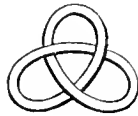

For *four* intersections our choice in the even places is restricted to C or D for the second, D or A for the fourth, &c., as expressed below,

$$\begin{array}{cccc} C & D & A & B \\ D & A & B & C. \end{array}$$

Now, if we take C to begin with, we obviously *must* take D next, else we shall not get it at all. Similarly A *must* come third. And if we begin with D, we *must* end with C, so that this case also is determinate. The only possible sets, therefore, are given by these two rows as they are written. But it is obvious that, as they are in cyclical order, the full schemes will be identical if one be read from the beginning, the other from the A in the even places. Thus they represent the same arrangement, and the sole knot with four intersections has the scheme

$$A C B D C A D B | A.$$

One of its two projections is given by the annexed figure:—

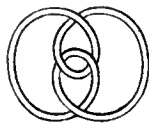

§ 7. When we have *five* intersections, our choice for the even places in order is limited to the following groups of three for each, viz.:—

$$\begin{array}{cccccc} C & D & E & A & B \\ D & E & A & B & C \\ E & A & B & C & D. \end{array}$$

This gives the following thirteen arrangements:—

- (1) C D E A B
- (2) C E A B D
- (3) C E B A D
- (4) C A E B D
- (5) D E A B C
- (6) D E B A C
- (7) D E A C B
- (8) D A E B C
- (9) D A E C B
- (10) E D A B C
- (11) E D A C B
- (12) E D B A C
- (13) E A B C D.

Now of these (1), (5), and (13) are unique; (6), (7), (8), and (10) can be obtained from (2) by cyclical alteration of the letters and bringing the last to be the beginning, and by the same process (4), (9), (11), (12) may be deduced from (3).

Hence the only possible forms are included in the following arrangements for the letters in the even places:—

C D E A B  
C E A B D  
C E B A D  
D E A B C  
E A B C D.

Of these the 1st, 3rd, and 5th violate the conditions laid down in § 5 above. Hence there are but two schemes for five intersections, viz.:—

A C B E C A D B E D | A,

of which this is one of the four forms



and

A D B E C A D B E C | A,

one of the two forms of which is the pentacle or Solomon's seal,



§ 8. The case of six intersections gives the following choice:—

C D E F A B  
D E F A B C  
E F A B C D  
F A B C D E.

I found, by trial, that there are 80 possible arrangements included in this form; and that the following 20 alone are distinct. I have appended to each the number of apparently different forms in which it occurs among the 80 arrangements:—

1. C D E F A B Unique 2. C D F B A E Six forms 3. C D F A B E Six forms 4. C D A F B E Six forms 5. C D B F A E Three forms 6. C E F B A D Six forms 7. C E F A B D Six forms 8. C E A F B D Three forms 9. D E F A B C Unique 10. C F E B A D Two forms		11. E F A B C D Unique 12. D F A B C E Six forms 13. C F A B D E Six forms 14. D F A C B E Six forms 15. D F B A C E Three forms 16. C F B A D E Six forms 17. C A F B D E Six forms 18. C A B F D E Three forms 19. D A F C B E Two forms 20. F A B C D E Unique
---	--	--

Of these, all but (5), (6), (7), (8), (12), (14), (15), (18), violate the conditions of § 5, and therefore do not correspond to real knots. Of those excepted the schemes agree in pairs when the branch first taken from the starting-point is changed.

Hence there are only *four* forms of 6-fold knottiness. These are as follows:—

( $\alpha$ ). (5) and (18) agree in giving the scheme

A C B A C B D F E D F E | A,

of which one form is the following:—

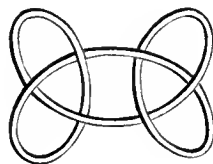

This form consists of two *separate* trefoil knots.

( $\beta$ ). (6) and (14) give the scheme

A C B E C F D B E A F D | A,

one form of which is as follows:—



(γ). From (7) and (12) we have

$$A C B E C F D A E B F D | A,$$

which has as one form

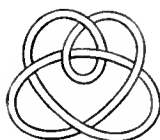

(δ). (8) and (15) give

$$A C B E C A D F E B F D | A,$$

of which one form is

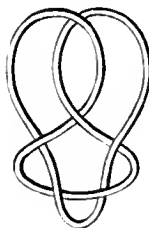

§ 9. The case of *seven* intersections is the only other to which I have found leisure to apply this method. As I did not see how otherwise to make certain that I had got all possible forms, I wrote out all the combinations of seven different letters, one from each column (in order) of the scheme—

C	D	E	F	G	A	B
D	E	F	G	A	B	C
E	F	G	A	B	C	D
F	G	A	B	C	D	E
G	A	B	C	D	E	F

These I thus found to amount to 579. Then, by the help of an improvised arrangement of cardboard, somewhat resembling *Napier's Bones*, I rapidly struck off six

of each equivalent set of 7. Thus 87 forms in all were left, viz., one form from each of 82 groups of seven, and 5 unique forms. Here they are—

1. C D E F G A B	30. C E B G D A F	59. C A F G B E D
2. C D E G A B F	31. C E B A G D F	60. C A F G D B E
3. C D E A G B F	32. C F G A B D E	61. C A F B G E D
4.* C D E B G A F	33.* C F G A D B E	62. C A G B D E F
5. C D F B G A E	34.* C F G A B E D	63.* C A B G D E F
6. C D F G B A E	35. C F G B A E D	64. D E F G A B C
7. C D F A G B E	36. C F G B A D E	65. D E G A B C F
8. C D G F A B E	37. C F G B D A E	66. D E G A C B F
9. C D G F B A E	38.* C F A G B D E	67.* D E G B A C F
10. C D G A B E F	39.* C F A G D B E	68. D E G C A B F
11. C D G B A E F	40.* C F A G B E D	69. D E A G B C F
12. C D A G B E F	41. C F A B G D E	70. D E A G C B F
13.* C D A B G E F	42. C F A B G E D	71.* D F G A B C E
14.* C D B A G E F	43. C F B G A D E	72.* D F G A C B E
15.* C D B G A E F	44. C F B G D A E	73. D F G B A C E
16. C E F G A B D	45. C F B G A E D	74. D F A G C B E
17.* C E F G B A D	46. C F B A G E D	75. D G A B C E F
18. C E F G A D B	47. C F B A G D E	76. D G A C B E F
19. C E F A G B D	48. C G E B A D F	77. D G B A C E F
20.* C E G F B A D	49. C G E B D A F	78. D G B C A E F
21. C E G F D A B	50. C G F A B D E	79. D A G B C E F
22.* C E G A B D F	51. C G F A B E D	80. D A G C B E F
23. C E G A D B F	52.* C G F A D B E	81.* E F G A B C D
24.* C E G B A D F	53. C G F B A D E	82. E G A B C D F
25. C E G B D A F	54. C G F B A E D	83.* E G A B D C F
26.* C E A G B D F	55. C G A F D B E	84. E G A C B D F
27. C E A G D B F	56. C G A B D E F	85.* E G B A D C F
28. C E A B G D F	57. C G B A D E F	86. F G A B C D E
29. C E B G A D F	58. C A F G B D E	87. G A B C D E F

On testing these by the rules of § 5, I found that 22 only, viz., those marked with an asterisk, correspond to real knots.

§ 10. When we study these groups by the method of § 5, we find that more than one of them correspond to different readings of the scheme of one and the same knot. Of course that knot will be the least symmetrical which has the greatest number

of essentially different schemes. The following grouping has thus been arrived at (the notation is that of § 5 above):—

	<i>d o</i>	<i>d e</i>	<i>r o</i>	<i>r e</i>
I.	(4) (13)	1,(63) 6,(15)	(63) (15)	6,(4) 1,(13)
II.	(17)	3,(83)	5,(83)	2,(17)
III.	(20)	3,(85)	3,(85)	(20)
IV.	(22)	6,(33)	(22)	6,(33)
V.	(24)	(39)	(26)	5,(52)
VI.	(34)	(34)	6,(34)	6,(34)
VII.	(38)	(67)	(67)	(38)
VIII.	(40)	6,(40)	6,(40)	(40)
IX.	(71)	(71)	(71)	(71)
X.	(72)	(72)	5,(72)	5,(72)
XI.	(81)	(81)	(81)	(81)
	(14)	(14)	(14)	(14)

Thus it appears that the knot V., represented by any of the four schemes (24), (26), (39), and (52), is devoid of symmetry, while VI., VIII., IX., X., XI. have the highest symmetry. No number has been in this table affixed to (14), because it is only accidentally a 7-fold knot. It is represented by the third figure in § 2 above, and when the nugatory crossing is removed, it becomes ( $\alpha$ ) of the 6-fold type, § 8. Also it will be noticed that (4) and (63), although their common scheme differs from that of (13) and (15), are included with them under I. The reason is that the knot represented is a composite one, consisting of a 3-fold and a 4-fold knot, and that either may be slipped along the string or wire into any position whatever relative to the other. But even with this licence it appears that there are only 4 really distinct schemes.

In the second and third rows of figures of Plate IV. projections of each of these classes of 7-fold knottiness are given, with the number of the class attached.

§ 11. But the knots represented by these eleven forms are not all distinct. It will readily be seen that (by the process of inversion of § 15 below) II., when formed of wire, with crossings + and - alternately, may be brought into the form (whose *perversion* will be found in Sir W. Thomson's paper on "Vortex-Motion," *Trans. R.S.E.*, 1867-68, p. 244)

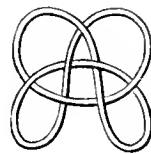



while IV. may be modified into

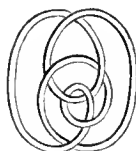

These are two of the three figures of 7-fold knots given as examples by Listing: and he has stated, though without any explanation, that these two forms are equivalent, *i.e.*, convertible into one another. Hence II. and IV. form but one class of 7-fold knot.

How to effect this transformation has been already hinted in § 4. It is merely the passing of a crossing from one loop of the string to another (which intersects it twice) by a *twist* through two right angles. And the diagrams 5, 6, 7 of Plate IV. show the nature of this transformation, as well as of two others which I have since detected, *viz.*, that of III. into V., and of VI. into VII. Hence there are in reality only *eight* distinct forms of 7-fold knottiness.

Thus, as the result of the last six sections, we have the following table:—

Knottiness,	3,	4,	5,	6,	7.
No. of Forms,	1,	1,	2,	4,	8.

§ 12. I have not attempted the application of the preceding method to forms with more than 7 intersections. Prof. Cayley and Mr Muir kindly sent me general solutions of the problem, "*How many arrangements are there of n letters, when A cannot be in the first or second place, B not in the second or third, &c.*" Their papers, which will be found in the *Proceedings R.S.E.*,\* of course give the numbers 13, 80, and 579, which I had found by actually writing out the combinations for 5, 6, and 7 letters. But they show that the number for 8 letters is 4738, and that for 9, 43,387; so that the labour of the above-described process for numbers higher than 7 rises at a fearful rate. I cannot spare time to attack the 8-fold knots, but I hope some one will soon do it. There is little chance of anything more than that, at least of an exhaustive character, being done about knots in this direction, until an analytical solution is given of the following problem:—

*Form all the distinct arrangements of n letters, when A cannot be first or second, B not second or third, &c.*

[Arrangements are said to be distinct when no one can be formed from another by cyclic alteration of the letters, at every step bringing the last to the head of the row, as in § 5.] This, I presume, will be found to be a much harder problem than that of merely *finding the number* of such arrangements, which itself presents very grave difficulties, at least where *n* is a composite number. In fact it is probable that the solution of these and similar problems would be much easier to effect by means

\* 1877, p. 338, and p. 382.

of special (not very complex) machinery than by direct analysis. This view of the case deserves careful attention.

In a later section it will be shown how, by a species of *partition*, the various forms of any order of knottiness may be investigated. But we can never be quite sure that we get *all* possible results by a semi-tentative process of this kind. And we have to try an immensely greater number of partitions than there are knots, as the great majority give links of greater or less complexity.

§ 13. But even supposing the processes indicated to have been fully carried out for 8, 9, and 10-fold knottiness, a new difficulty comes in which is not met with, except in a very mild form, in the lower orders. For when a knot is single, *i.e.*, not composite or made up of knots (whether interlinked or not) of lower orders, any deviation from the rule of alternate + and - at the crossings gives it, in general, nugatory crossings, in virtue of which it sinks to a lower order. But when it is composite, and the component knots are separately irreducible, the whole is so. Thus *there are more distinct forms of knots than there are of their plane projections*. For instance, the first species ( $\alpha$ ) of the 6-fold knots (§ 8) may be made of three essentially different forms, for the separate "trefoil" knots of which it is made may (when neither is nugatory) be both right-handed, both left-handed, or one right and the other left-handed. This species is thus, from the physical point of view, capable of furnishing *three* quite distinct forms of vortex-atom. And it will presently be shown that in each of these forms it is capable of having regular alternations of + and -, or a set of sequences at pleasure.

At least one knot of every even order is *amphicheiral*, *i.e.*, right or left-handed indifferently, but no knot of an odd order can be so. Hence, as there is but one 3-fold knot form, and one 4-fold, there are two possible 3-fold vortices, right and left-handed, but only one 4-fold. A combination of two trefoil knots gives, as we have seen, three distinct knots; that of two 4-fold knots would give an 8-fold, with only one form. When a 3-fold and a 4-fold are combined, as in Class I. of § 10, there are two distinct vortices, for the trefoil part may be right or left-handed. Thus it appears that though we have shown that there are very few distinct outlines of knots, at least up to the 7-fold order, and though probably only a very small percentage of these would be stable as vortices, yet the double forms of non-amphicheiral knots give more than one distinct knot for each projected form into which they enter as components.

## PART II.

### *The number of Forms for each Scheme.*

§ 14. A possible scheme being made according to the methods just described, with the requisite number of intersections, let it be constructed in cord, with the intersections alternately + and -. Then [since all schemes involving essentially nugatory crossings, like those mentioned in § 2, must be got rid of, as they do not really possess the requisite number of intersections] no deformation which the cord can suffer will

reduce, though it may increase, the number of double points. If it *do* increase the number, the added terms will be of the nugatory character presently to be explained. If it do not increase that number, the scheme will in general still represent the altered figure. For, as we have seen, the scheme is a complete and definite statement of the nature of the knot. But, as already stated, in certain cases the knot can be distorted so as no longer to be represented by the same scheme.

All deformations of such a knotted cord or wire may be considered as being effected by bending at a time only a limited portion of the wire, the rest being held fixed. This corresponds to changing the point of view *finitely* with regard to the part altered, and yet *infinitesimally* with regard to all the rest. This, it is clear, can always be done, as the *relative* dimensions of the various coils may be altered to any extent without altering the character of the knot. In general such deformations may be obtained by altering the position of a luminous *point*, and the plane on which it casts a shadow of the knot. Any addition to the normal number of intersections which may be produced by this process is essentially nugatory. As is easily seen, it generally occurs in the form of the avoidable overlapping of two branches, giving *continuations of sign*.

The process pointed out in § 11 gives a species of deformation which it is perhaps hardly fair to class with those just described, though by a slight extension of mathematical language such a classification may be made strictly accurate. It may be well to present, in passing, a somewhat different view of the application of this method. Thus, it is obvious at a glance that the two following figures are mere *distortions* of the second form of the 4-fold knot figured in § 17 below:—



Also it will be seen that by twisting, the dotted parts being held fixed, either of these may be changed into the other, or changed to its own reverse (as from left to right).

We may now substitute what we please for the dotted parts. I give only the particular mode which reproduces the two forms stated by Listing to be equivalent:—



Another mode of viewing the subject, really depending on the same principles, consists in fixing temporarily one or more of the crossings, and considering the impossibility of unlocking in any way what is now virtually two or more *separate*

interlacing closed curves, or a single closed curve with full knotting, but with fewer intersections than the original one.

Another depends upon the study of the cases of knots in which one or more crossings can be got rid of. Here, as will be seen in § 33 below, it is proved that *continuations* of sign are in general lost when an intersection is lost; so that, as our system has no continuations of sign, it can lose no intersections.

§ 15. Practical processes for producing graphically all such deformations as are represented by the same scheme are given at once by various simple mechanisms. Thus, taking O any fixed point whatever, let  $p$ , a point in the deformed curve, be found from its corresponding point, P, by joining PO and producing it according to any rule such as

$$PO \cdot Op = a^2,$$

or

$$PO + Op = a, \text{ \&c., \&c.}$$

The essential thing is that points near O should have images distant from O, and *vice versa*. And  $p$  must be taken in PO *produced*, else the distorted knot is altered from a right-handed to a left-handed one, and *vice versa*, as will be seen at once by taking the image of the crossing figured in § 1 above.

It is obvious, from the mode of formation, that these figures are all represented by the same scheme,—for the scheme tells the order in which the various crossings occur,—and it is easy to show that they give merely different views of the same knot. The simplest way of doing this is to suppose the knot projected on a sphere, and *there* constructed in cord, the eye being at the centre. Arrange so that one closed branch, *e.g.*, A—A, forms nearly a great circle. Looking towards the centre of the sphere from opposite sides of the plane of this great circle, the coil presents exactly the two appearances related to one another by the deformation processes given above. What was inside the closed branch from the one point of view is outside it from the other, and *vice versa*. In fact, because the new figure is represented by the same scheme as the old, the numbers of sides of the various compartments are the same as before, and so also is the way in which they are joined by their corners. The deformation process is, in fact, simply one of *flying*, an excellent word, very inadequately represented by the nearest equivalent English phrase “turning outside in.”

Hence to draw a scheme, select in it any closed circuit, *e.g.*, A...A—the more extensive the better, provided it do not include any less extensive one. Draw this, and build upon it the rest of the scheme; commencing always with the common point A, and passing each way from this to the *next occurring* of the junctions named in the closed circuit. [It is sometimes better to construct both parts of the rest of the scheme *inside*, and then invert one of them, as we thus avoid some puzzling ambiguities.] Inversions with respect to various origins will now give all possible forms of the scheme, though not necessarily of the knot.

§ 16. Applying these methods to the "trefoil" knot (§ 6)

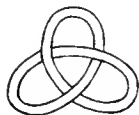

we easily see that if  $O$  be external, or be inside the inner *three*-sided compartment, we reproduce (generally with much *distortion*, but that is of no consequence, § 2) the same form; but if  $O$  be in any one of the *two*-sided compartments, we have the form

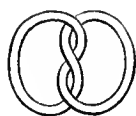

This again is reproduced from itself if  $O$  be external, or be within either of the *two*-sided compartments. But it gives the trefoil knot if  $O$  be placed inside either of the *three*-sided compartments.

Here notice that the angles of the *two*-sided compartments are left-handed, and those of the *three*-sided right-handed in each of the figures. The *perverted* or right-handed form is of course



and its solitary deformation is the perversion of the other figure above.

§ 17. When we come to the deformations of the single 4-fold knot

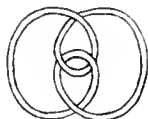

we obtain a very singular result. If we place  $O$  external to the figure, we simply reproduce it; but if we put  $O$  inside the *two*-sided compartment in the middle we get the *perversion* of the same figure.

Again, if we place  $O$  in either of the *boundary* *three*-sided compartments we get



but if we place it in either of the *interior* three-sided spaces we get the *perversion* of this last figure.

Thus this 4-fold knot, in each of its forms, can be deformed into its own *perversion*. In what follows all knots possessing this property will be called *Amphicheiral*.

§ 18. The first of the two 5-fold knots (§ 7) has the following forms:—

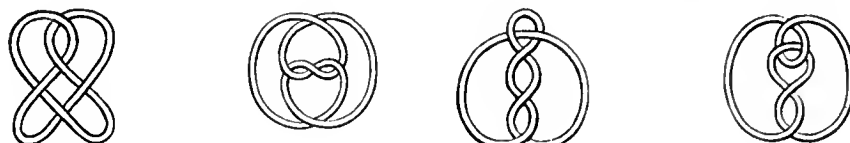

These I found were long ago given by Listing as reduced forms of a reducible 7-fold knot, and I have now substituted for my former drawing of the second form his more symmetrical one.

The second of the 5-fold knots has only two forms, viz.:—



§ 19. Plate IV. figs. 2, 3, 4, give various forms of the 6-fold knot distinguished as  $\alpha$  in the classification in § 8. It will be seen that in the first of these the crossings are alternately over and under, but that it is not so in the others.

And in fig. 8 we have a collection (not complete) of forms of various species of the 7th order, drawn so as to show their relation to a lower form—the trefoil knot. It will be seen that in none of these is the connection merely *apparent*, the trefoil part having its signs alternately + and – if those of the complete knot have this alternation. But if, for instance, we had drawn the fine line horizontally through the trefoil, so as to divide each of the upper two-cornered compartments into two three-cornered ones, we should have got No. II. of the 7-fold forms, and the original trefoil would have been rendered only *apparent*.

§ 20. In my British Association paper, No. XXXVIII. above, I showed that any closed plane curve, or set of closed plane curves, provided there be nothing higher than double points, divides the plane into spaces which may be coloured black and white alternately, like the squares of a chess-board, or, to take a closer analogy, as the adjacent elevated and depressed regions of a vibrating plate, separated from one another by the nodal lines (Plate IV. figs. 9 and 10). I afterwards found that Listing had employed in his notation for knots, in which the crossings are alternately over and under, a representation which comes practically to the same thing; depending as it does on the fact that in such a knot all the angles in each compartment are either right or

left-handed, and that these right and left-handed compartments alternate as do my black and white ones.

I have since employed a method, based on the above proposition, as a mode of symbolising the form of the projections of a knot, altogether independent of its reduceibility. I was led to this by finding that Listing's notation, though expressly confined to reduced knots, in which each compartment has all its angles of the same character, is ambiguous: in the sense that a *Type-Symbol*, as he calls it, may in certain cases not only stand for a linkage as well as a knot, but may even stand for two quite different reduced knots incapable of being transformed into one another\*. The *scheme*, already described, has no such ambiguity, but it is much less easy to use in the classification of knots. Hence, following Listing, I give the number of corners of each compartment, but, unlike him, only of those which are black or of those which are white. But I connect these in the diagram by lines which show how they fit into one another in the figure of the knot. An inspection of Plate IV. figs. 11 and 12 (species VII. of sevenfold knottiness) will show at once how diagrams are arrived at, either of which fully expresses the projection of the knot in question by means of the black or of the white spaces singly. The connecting lines in the diagrams evidently stand for the crossings in the projection, and thus, of course, either diagram can be formed by mere inspection of the other†, and the rule for drawing the curve when the diagram is given is obvious. Thus the annexed diagram shows the result of the process as applied to a symmetrical symbol.

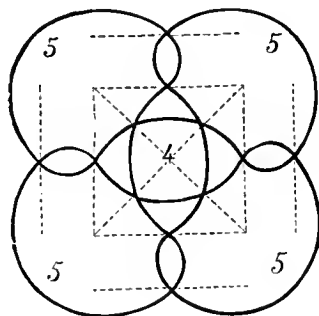

An inspection of one of these diagrams shows at once

(1) The number of joining lines is the same as the number of crossings. Hence, as each line has two ends, the sum of the numbers representing the number of corners in either the black or the white spaces is twice the number of crossings.

(2) Every additional crossing involves one additional compartment, for the abolition of a crossing runs two compartments into one. But where there is no crossing there are two compartments, the inside and outside (*Amplex*, in Listing's phraseology), of

\* *Proc. R.S.E.* 1877, p. 310 (footnote), and p. 325.

† Some further illustrations of this will be found in the abstract of my paper on "Links," *Proc. R.S.E.* 1877, p. 321.

what must then be merely a closed oval. Thus when there are  $n$  crossings there are  $n + 2$  compartments.

(3) No compartment can have more than  $n$  corners. For, as the whole number of corners in the black or white compartments is only  $2n$ , if one have more than  $n$ , the rest must together have less, and thus some of the joining lines in the diagram must *unite the large number to itself, i.e.,* must give essentially nugatory intersections.

As an illustration, let us use this process in giving a second enumeration or delineation of the forms of 7-fold knottiness. The numbering of the various forms is the same as that already employed in §§ 10, 11 above.

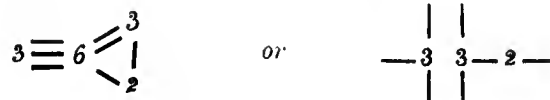

I.

The second form of this symbol is particularly interesting as consisting of two parts. This accords with the composite nature of the knot.



II.

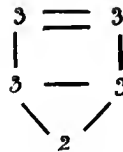

III.

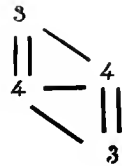

IV.

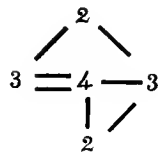

V.

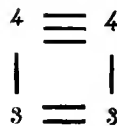

VI.

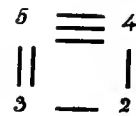

VII.

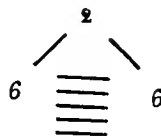

VIII.

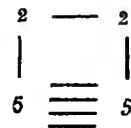

IX.



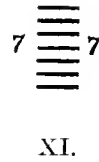
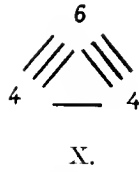

The relations of equivalence in pairs among six of these forms, which were pointed out in § 11 and in Plate IV. figs. 5, 6, 7, are even more clearly seen as below:—

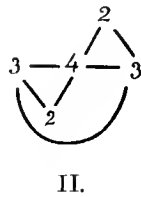

=

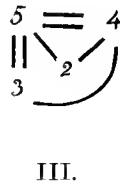
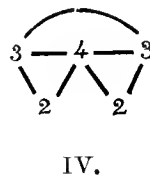

=

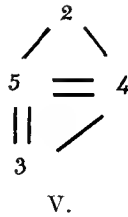

=

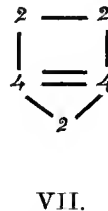

where the mode of passing from one form to the equivalent one is obvious.

§ 21. A tentative method of drawing all possible systems of closed curves with a given number ( $n$ ) of double points is thus at once obvious.

Write all the partitions of  $2n$ , in which no one shall be greater than  $n$  and no one less than 2. Join each of these sets of numbers into a group, so that each number has as many lines terminating in it as it contains units. Then join the middle points of these lines (which must not intersect one another) by a continuous line which intersects itself at these middle points and there only. When this can be done we have the projection of a *knot*. When more continuous lines than one are required we have the projection of a *linkage*.

To give simple examples of this process, let us limit ourselves to 4 and 5 intersections.

The only partitions of 8, subject to the conditions above, are

- (1) 4 4
- (2) 4 2 2
- (3) 3 3 2
- (4) 2 2 2 2

Now the number of black and white compartments together must in this case be 4 + 2. Hence there are but four combinations to try, viz., (1) and (4), (2) and (2), (3) and (3), (2) and (3). Of these, the last is impossible; the others are as in Plate V. fig. 16. The third is the amphicheiral knot already spoken of, and the second may for the same reason be called an *amphicheiral link*.

The partitions of 10, subject to our rule, are

- 5 5
- 5 3 2
- 4 4 2
- 4 3 3
- 4 2 2 2
- 3 3 2 2
- 2 2 2 2 2

and the four figures (Plate V. fig. 17) give the only valid combinations of these. The third and the first are the knots already described (§ 18), the others are links.

§ 22. The spherical projection already mentioned (§ 15) will in general allow us to regard and exhibit any knot as a more or less perfect *plait*. It does so perfectly whenever the coil is *clear*, i.e., when all the windings of the cord may be regarded as passing in the same direction round a common vertical axis thrust through the knot. When the coil is not clear some of the cords of the plait are doubled back on themselves. Thus by drawing the plait corresponding to a given scheme we can tell at once whether one of its forms is a clear coil or not.

Let us confine our attention for a moment to clear coils. It is easy to see that

*If the number of windings is even the number of crossings is odd, and vice versâ.*

Various proofs of this may be given, all depending on the fundamental theorem of § 1, but the following one is simple enough, and will be useful in some other applications.

First, in a clear coil of two turns there must be an odd number of intersections. For there must be one intersection, and the two loops thus formed must have their other intersections (if any) in pairs.

Now begin with any point in a clear coil, where the curve intersects itself for the first time. The loop so formed intersects the rest in an even number of points. Hence every turn we take off removes an odd number of intersections. Thus, as two turns give an odd number (or, more simply, as one turn gives none), the proposition is proved.

Thus, to form the symmetrical clear coil of two turns and of any (odd) number of intersections, make the wire into a helix, and bring one end through the axis in the same direction as the helix (not in the opposite direction, as in Ampère's *Solenoids*), then join the ends. [The solenoidal arrangement, regarded from any point of view, has only nugatory intersections.]

§ 23. A very curious illustration of the irreducible clear coils which have two turns only is given by the edges of a long narrow strip of paper. Bend it, without twisting, till the ends meet, and then paste them together. The two edges will form separate non-linked closed curves without crossings.

Give the slip *one half twist* (*i.e.* through  $180^\circ$ ) before pasting the ends together. The edges now form one continuous curve—a clear coil of two turns with *one* (nugatory) crossing.

Give *one full twist* before pasting. Each edge forms a closed curve, but there are two crossings. The curves are, in fact, once linked into one another. (See Plate IV. fig. 13.)

Give *three half twists* before joining. The edges now form one continuous clear coil with three intersections.

*Two full twists* give two separate closed curves with four crossings, *i.e.*, twice linked together. (See Plate V. fig. 12.)

*Five half twists* give the pentacle of § 7 above. And so on. In all these examples, from the very nature of the case, the crossings are alternately + and -.

§ 24. Now suppose that, in any of the above examples, after the pasting, we cut the slip of paper up the middle throughout its whole length.

The first, with no twist, splits of course into two separate simple circuits.

That which has half a twist, having originally only one edge, and that edge not being cut through in the process of splitting, remains a closed curve. It is, in fact, a clear coil of two turns, which, having only one intersection, may be opened out into a single turn. But in this form it has *two whole* twists, half a twist for each half of the original strip, and a whole twist additional, due to the bending into a closed circuit.

That with one whole twist splits, of course, into two interlinking single coils, each having one whole twist.

That with three half twists gives, when split, the trefoil knot, and when flattened out it has three whole twists.

From two whole twists we get two single coils twice linked, each with two whole twists. This result may be obviously obtained from a continuous strip, *with only half a twist*. One continued cut, which takes off a strip constantly equal to one quarter of the original breadth of the slip, gives a half twist ring of half breadth, intersecting *once* a double twist ring of quarter breadth. A second cut splits the wider ring into one similar to the narrow one, but there is now double linking.

§ 25. A good many of these relations may be exhibited by dipping a wire, forming a two-coil knot, into Plateau's glycerine soap solution, and destroying the film which fills up the clear interior of the coil. Neglecting the surface curvature of the remaining film, it has twists similar to those of the paper strips above treated, and the integral amounts of twist show how far the wire-knot is, if at all, reducible.

This mode of regarding a clear coil of two turns, as, in certain cases, the continuous edge of a strip of paper whose ends are pasted together after any odd number of half twists, is one of many ways in which we are led to study *all clear coils* as specimens of more or less perfect *plaiting*, the number of threads plaited together being the same as the number of turns of the coil. Another mode in which we are led to the same way of regarding them is by supposing a cylinder to be passed through the middle of the (flattened) clear coil, and then to expand so as to draw all the turns tight. As there can be only a finite number of intersections, we have always an infinite choice of generating lines of the cylinder on which no intersection lies. Suppose the whole to be cut along such a line and rolled out flat. It would, of course, be a more or less perfect plait, but with a special characteristic, depending upon the fact that *it is formed from one continuous cord or wire*.

Call the several laps of the cut cord  $\alpha$ ,  $\beta$ ,  $\gamma$ , &c. Then we may arrange the cut ends anyhow as follows:— $\alpha$  to  $\gamma$ ,  $\gamma$  to  $\epsilon$ ,  $\epsilon$  to  $\beta$ ,  $\beta$  to  $\delta$ ,  $\delta$  to  $\alpha$  if there be but five; and similarly for any other number, *exhausting all before repeating any one oftener than once*. We may now, after having settled their order, *change their designations*, so as to name them, as they occur, in the natural order of the alphabet. Thus any such plait may be represented by a diagram as in Plate IV. fig. 14, where the dotted parts may cross and recross in any conceivable way, but must begin and end as above.

The number of ways in which such coils can be exhibited in plaits essentially distinct from one another is therefore, if  $n$  be the number of laps,  $\overline{n-1} \overline{n-2} \dots 2.1$ . All the other possible arrangements,  $n-1$  times the last written number, correspond to links or, at all events, to more than one continuous cord.

§ 26. From this point of view another notation for clear coils may be given in the form

$$\begin{array}{l} \alpha \gamma \beta \alpha \\ \beta \alpha \gamma \beta \dots \end{array}$$

Here  $\alpha, \beta, \gamma, \dots$  are, as above, the several strings plaited, so that in the coil  $\beta$  is the prolongation of  $\alpha, \gamma$  that of  $\beta$ , &c., and  $\alpha$  that of the last of the series. The expression  $\frac{\alpha}{\beta}$  means that  $\alpha$  crosses *over*  $\beta$ . It is sometimes useful to indicate whether a crossing takes place to the right or left. This is done by putting + or - over the symbol. Thus the four crossings above may be more fully written as

$$\begin{array}{cccc} + & - & + & - \\ \alpha & \gamma & \beta & \alpha \\ \beta & \alpha & \gamma & \beta \dots \end{array}$$

The properties of this notation were examined in detail in my first paper; but as they are more curious than useful, I merely mention one or two.

Thus the combination just written cannot be simplified in itself; but

$$\begin{array}{cccc} + & - & - & - \\ \alpha & \gamma & \gamma & \alpha \\ \beta & \alpha & \beta & \beta \end{array} = \begin{array}{cc} \gamma & \gamma \\ \beta & \alpha \end{array}, \text{ \&c.}$$

This notation requires care. For instance, the terms

$$\begin{array}{c} \alpha \alpha \\ \beta \beta \end{array}$$

are simply nugatory, and may be cancelled. But, on the other hand, the terms

$$\begin{array}{c} \alpha \beta \\ \beta \alpha \end{array}$$

usually add to the beknottedness of the whole scheme.

When the scheme is not compatible with a clear coil there occur terms of the form

$$\begin{array}{c} \alpha \\ \alpha, \end{array}$$

and the application of this method becomes very troublesome.

§ 27. A question closely connected with plaited clear coils is that of the numbers of possible arrangements of given numbers of intersections in which the *cyclical* order of the letters in the 2nd, 4th, 6th, &c., places of the scheme shall be the same as that in the 1st, 3rd, 5th, &c., *i.e.*, the alphabetical. Instances of such have already been given above. In the first scheme of § 5, for example, the letters in the even places are

$$D E A B C.$$

Here the cyclical order of the alphabet is maintained, but A is postponed by two places. It is easy to see that the following statements are true.

Whatever be the number of intersections a postponement of *no* places leads to nugatory results.

A postponement of one place is possible for three and for four intersections only.

Postponement of two places is possible only for (*four*), five, and eight—three for seven and ten—four for nine and fourteen—five for (*eight*), eleven and sixteen,—six for (*ten*), thirteen, and twenty, &c. Generally there are in all cases  $n$  postponements for  $2n+1$  intersections; and for  $3n+2$ , or  $3n+1$  intersections, according as  $n$  is even or odd. The numbers which are italicised and put in brackets above, arise from the fact that a postponement of  $r$  places, when there are  $n$  intersections, gives the same result as a postponement of  $n-r-1$  places. [It will be observed that this cyclical order of the letters in the even places is possible for *any* number of intersections which is not 6 or a multiple of 6.]

When there are  $n$  postponements with  $2n+1$  intersections the curve is the symmetrical double coil, *i.e.*, the plait is a simple *twist*.

The case with  $3n+2$  or  $3n+1$  intersections is a clear coil of three turns, corresponding to a regular plait of three strands.

Figures 16, 17 of Plate IV. give the diagrams corresponding to the latter case for  $n=2, 3$  respectively; *i.e.*, with 8 and 10 crossings. The diagrams 15 and 18, constructed according to the same plan for 6 and 12 intersections, show why there are no multiples of six in this form of coil. In fact, whenever the number of crossings in this three-ply plait is a multiple of 6, the strands are separate closed curves.

### PART III.

#### *Methods of Reduction.*

§ 28. Before taking up the question of the complexity of a knot, a word or two must be said about the methods of reducing any given knot to its simplest form. I have not been able as yet to find any general method of doing this, nor have I even discovered, what would probably solve this difficulty, any perfectly general method of pronouncing at once from an inspection of its scheme or otherwise, whether a knot is reducible or not. It is easy to give multitudes of special conformations in which reduction can always be effected; but of these I shall give only a few, with the view of showing their general character.

One very simple case of such reduction has already been given, *viz.*, *where a letter occurs twice in succession.*

For, if we have as part of a scheme, the letters

... P Q Q R ...

the corresponding part of the coil must have the form shown in Plate IV. fig. 19. Whichever way the crossing at Q is effected, the loop can be at once got rid of, and it is thus nugatory, *because the scheme shows that it is not intersected by any other branch.*

If we put in the signs of the crossings, they must obviously be different for the two Q's; and thus in

$$\dots P Q Q R \dots$$

$$+ -$$

we may treat them as  $+Q - Q = 0$ , and obliterate Q altogether.

An immediate consequence of this is, of course, that any group such as

$$\dots P Q R R Q P \dots$$

whatever be the number of letters arranged in this form, may be wholly struck out. Cases corresponding to this have been already figured in § 1.

§ 29. Another useful step in simplification occurs when we have a scheme containing the following terms:—

$$\dots P Q \dots P Q \dots$$

$$+ + \quad - -$$

for then both P and Q may be struck out.

[*N.B.*—The *order* of P and Q need not be the same at each occurrence, the essential thing is that they should *twice occur together, and with like signs*. This explanation shows that the process is not confined to clear coils.]

For the corresponding part of the diagram must evidently be of the form shown in Plate IV. fig. 20, since the scheme shows that there are no intersections between P and Q on either branch. Hence, as P and Q have the same sign for each branch, one branch may be slipped off from the other without otherwise altering the coil.

If a single turn of the coil pass across between P and Q, the only ways in which it can prevent the slipping off just described are that shown in Plate IV. fig. 21, and the same looked at from the other side, *i.e.*, with all the signs changed.

Hence in the scheme

$$\dots P R Q \dots P S Q \dots R S \dots$$

$$+ + \quad - -$$

(where the order is again indifferent in each of the groups) we can always leave out P and Q, unless R be negative and S positive, *i.e.*, unless this part of the scheme has in itself the greatest possible number of changes of sign.

But when we *can* thus strike out P and Q, it is necessary to observe that in R S or S R, which *must* occur at some other part of the scheme, the order is to be changed. Thus

$$\dots P R Q \dots P S Q \dots R S \dots$$

$$+ + + \quad - + - \quad - -$$

is simplified into

$$\dots R \dots S \dots S R \dots$$

$$+ \quad + \quad - -$$

§ 30. Such a portion as that figured in Plate IV. fig. 22 evidently goes out of itself, whatever be the character of B; *i.e.*, the whole of it

$$\begin{array}{c} \dots ABC ABC \dots \\ - + + - \end{array}$$

may be struck out of any scheme. In fact, whichever sign be given to B, § 29 applies and removes two of the intersections. Then § 28 disposes of the remaining one.

This is merely a particular case of the general and obvious theorem, that any portion of a coil which may be treated as a separate coil, and which, if alone, could be reduced, may be reduced *in situ*.

A more general theorem, which includes the preceding, is that, if in

$$\dots A B C \dots G H A \dots$$

the signs of B, C, ... G, H, where they occur between the two A's, are all alike, all these intersections, including A, may be struck out. This is quite obvious, because it indicates a complete turn of the coil entirely above or below the rest. When one or more of B, C, G, H has a different sign from the others, a less amount of simplification is usually still possible.

Along with this we may take the case of fig. 23. Here we have

$$\begin{array}{c} \dots P Q R P S \dots R Q S \dots \\ - - + + + \quad - + - \end{array}$$

If the sign of P were changed these parts of the scheme would contain alternately + and -. The scheme obviously loses three intersections, and becomes

$$\begin{array}{c} \dots Q \dots Q \dots \\ - \quad + \end{array}$$

If the signs in the complete knot, with the exception of that of P, were all + and - alternately, there will generally be farther reductions possible.

§ 31. A glance shows that the first of the diagrams, 24, 25, Plate IV., can be reduced to the second. Hence in the scheme of a knot

$$\begin{array}{c} \dots P Q R P \dots Q R \dots \\ + + - - \quad - + \end{array}$$

may be simplified into

$$\begin{array}{c} \dots Q R \dots R Q \\ + - \quad + - \end{array}$$

[*N.B.*—The essential point is that P and Q should have the *same* sign, and R the opposite. If Q and R had the same sign they might both be struck out, § 29. But if P and Q have different signs, as also Q and R, no simplification can be effected, though, as has been shown in § 11, a change of scheme is practicable.]



§ 32. The scheme

$$\begin{array}{ccccccc} \dots & A & B & C & \dots & E & F & G & \dots & \dots & A & M & N & \dots & P & Q & G & \dots \\ & + & + & + & & + & + & + & & & - & & & & & - & & \end{array}$$

always admits of striking out A and G. But special consideration is necessary as to what is to take the place of B, C, . . . E, F. Their substitutes will all be positive, and may be called *m, n, . . . p, q*, since they are in number the same as M, N, . . . P, Q—irrespective altogether of the number of B, C, . . . E, F. In fact, M and *m*, N and *n*, . . . &c., lie (as near one another, in pairs, as we please) on the several turns of the coil which intersect the arc A M . . . Q G. And *m, n, . . . &c.*, are on the *opposite* side of that arc from B, C, . . . F.

§ 33. There are numberless other special rules, but those just given are among the simplest, and they are in general sufficient for coils with only a moderate number of intersections. With the present notation it is not easy to classify them, or to show how they may be exhibited as particular cases of more general rules. We will therefore, for the present, employ them only for the simplification (where possible) of a few diagrams of knots. But it must be particularly noticed that the simplifications above are mainly such as *tend to remove continuations of sign from a scheme*, none of them but the first being applicable to a scheme whose signs present no continuations.

§ 34. *Examples.*

$$\begin{array}{cccccccccccccccc} \text{I.} & A & E & B & F & C & G & D & A & E & K & F & L & G & D & H & B & K & C & L & H & | & A \\ & - & + & + & + & - & + & - & + & - & + & - & + & - & + & - & - & - & + & - & + & \end{array}$$

This is, of course, rendered irreducible by changing the sign of B. It is figured Plate V. fig. 1.

[If we were to change the sign of F, L, H, the knot would acquire a great increase of beknottedness, and would consist, in its simplest form, of a pentacle and a trefoil knot linked together, as in Plate V. fig. 25.]

$$\begin{array}{ccccccc} (a) \text{ Now} & \dots & E & B & F & \dots & E & K & F & \dots & B & K & \dots \\ & & + & + & + & & - & + & - & & - & - & \end{array}$$

$$\begin{array}{ccccccc} \text{become} & \dots & B & \dots & K & \dots & K & B & \dots \\ & & + & & + & & - & - & \end{array}$$

(b) Two intersections being thus lost, the knot has now the form, Plate V. fig. 2, with the scheme

$$\begin{array}{cccccccccccccccc} A & B & C & G & D & A & K & L & G & D & H & K & B & C & L & H & | & A \\ - & + & - & + & - & + & + & + & - & + & - & - & - & + & - & + & \end{array}$$

$$\begin{array}{ccccccc} \text{Now in} & \dots & \dots & D & A & K & L & G & \dots \\ & & & + & + & + & & & \end{array}$$

with G before or D after, we can at once get rid of K, L, if A be put close to G.

(c) Hence the scheme becomes

$$\begin{array}{c} \text{B C A G D A G D H B C H} \mid \text{B} \\ + - - + - + - + - - + + \end{array}$$

and the knot is as in the figure 3, Plate V.

Now  $\text{H B} \dots \text{H B} \dots$  go out (§ 29).  
 $- - \quad + +$

(d) The scheme is now

$$\begin{array}{c} \text{C A G D A G D C} \mid \text{C} \\ - - + - + - + + \end{array}$$

so that C goes out by § 28, and we have finally

$$\begin{array}{c} \text{A G D A G D} \mid \text{A} \\ - + - + - + \end{array}$$

the trefoil knot.

II. The knot figured in Plate V. fig. 4 has no beknottedness.

III. That in fig. 5 is reducible to the trefoil.

These are left as exercises to the reader.

#### PART IV.

##### *Beknottedness.*

§ 35. Recurring to the two species of five-crossing knots discussed in § 18, we easily see that there is less entanglement or complication in the first species than in the second. For if the sign of *either* of the two crossings towards the top of the first figure be changed, it is obvious that it will no longer possess any but nugatory crossings. But if we change the sign of any one crossing in the pentacle, that crossing, and *one* only of the adjacent ones, become nugatory, so that the knot becomes the trefoil with alternating + and -. This, in turn, has all its intersections made nugatory by the change of sign of any one of them. Thus one change of sign removes all the knotting from the first of these knots, but two changes are required for the second.

In what follows the term *Beknottedness* will be used to signify the peculiar property in which knots, even when of the same order of knottiness, may thus differ: and we may define it, at least provisionally, as *the smallest number of changes of sign which will render all the crossings in a given scheme nugatory*. This question is, as we shall soon see, a delicate and difficult one. It is probable that it will not be thoroughly treated until one considers along with it another property, which may be called *Knotfulness*—to indicate the number of knots of lower orders (whether interlinked or not) of which a given knot is in many cases built up. But this term will not be introduced in the present paper.

§ 36. It may be well to premise a few lemmas which will be found useful in examining for our present purpose the plane projection of a knot.

( $\alpha$ ) Regarding the projection as a wall dividing the plane into a number of fields, if we walk along the wall and drop a coin into each field as we *reach* it, each field will get as many coins as it has corners, but those fields only will have a coin in each corner whose sides are all described in the same direction round. For we enter by one end of each side and leave by the other. The number of coins is four times the number of intersections; and two coins are in each corner bounded by sides by each of which we enter, none in those bounded by sides by each of which we leave. Hence a mesh, or compartment, which has a coin in each corner has all its sides taken in the same direction round; and we see by fig. 6, Plate V., that this is the case with twists in which the laps of the cord run opposite ways, not if they run the same way. Compare this with the remarks of § 35, as to the two species of 5-fold knottiness.

( $\beta$ ) To make this process give the distinction between crossing *over* and crossing *under*, we may suppose the two coins to be of different kinds,—silver and copper for instance. Let the rule be:—silver to the right when crossing *over*, to the left when crossing *under*. Then, however the path be arranged, of the four angles at each crossing, one will have no coins, the vertical or opposite corner will have *two* silver or *two* copper coins, the others *one* copper or *one* silver coin each.

It is easily seen that a reversal of the direction of going round leaves the single coins as they were, but shifts the pair of coins into the angle formerly vacant: also that in all deformed figures the circumstances are exactly the same as in the original. Hence we may divide the crossings into silver and copper ones, according as two silver or two copper coins come together. And the excess of the silver over the copper crossings, or *vice versâ*, furnishes an exceedingly simple and readily applied test (not, however, as will soon be seen, in itself absolutely conclusive of identity, though absolutely conclusive against it), which is of great value in arranging in family groups (those of each family having the same number of silver crossings), the various knots having a given number of intersections.

( $\gamma$ ) Or, still more simply, we may dispense altogether with the copper coins, so that, going round, we pitch a coin into the field to the *right* at each crossing *over*, to the *left* at each crossing *under*. When the coins are in the same angle the crossing is a silver one, when in two vertical angles it is copper. Each of these three processes has its special uses.

§ 37. This process, thus limited, is obviously intimately connected with that required for the estimation of the work necessary to carry a magnetic pole along the curve, the curve being supposed to be traversed by an electric current. Hence it occurred to me that we might possibly obtain a definite measurement of beknottedness in terms of such a physical quantity: as it obviously must be always the same for the same knot, and must vanish when there is no beknottedness. To make the measure complete, we must record the numbers of non-nugatory silver and copper

crossings separately, with the number to be deducted as due merely to the *coiling* of the figure. This last is a very important matter, and will be dealt with later.

§ 38. When unit current circulates in a simple circuit, it is known that the work required to carry unit magnetic pole once round any closed curve once linked with the circuit is  $\pm 4\pi$ . Instead of the current we may substitute a uniformly and normally magnetized surface bounded by the circuit. The potential energy of the pole in any position is measured by the spherical aperture subtended at the pole by the circuit; but its sign depends upon whether the north or south polar side is turned to the pole. Hence the pole has no potential energy when it is situated in the plane of the circuit but external to it, and the potential energy is  $\pm 2\pi$  when the pole just reaches the plane of the circuit internally.

In fact the electro-magnetic force exerted by an element  $d\alpha$  of a unit current, on a unit north pole placed at the origin of  $\alpha$ , is

$$\frac{V\alpha d\alpha}{T\alpha^3}$$

or, as we may write it,

$$V \cdot d\alpha \nabla \frac{1}{T\alpha}.$$

This is identical in form with the expression for the differential whose integral, taken round a closed circuit, is Ampère's *Directrice*\*.

Hence the element of work done by the closed circuit while the pole describes a vector  $\delta\alpha$ , is

$$\delta W = -S \cdot \delta\alpha \int \frac{V\alpha d\alpha}{T\alpha^3} = -S \cdot \delta\alpha \int d\alpha \nabla \frac{1}{T\alpha}.$$

But, if  $d\Omega$  be the spherical angle subtended at  $\alpha$  by a little plane area  $ds$ , whose unit normal vector (drawn *towards* the origin of  $\alpha$ ) is  $U\nu$ , obviously

$$d\Omega = \frac{S \cdot U\nu U\alpha}{T\alpha^2} ds = -S \cdot U\nu \nabla \frac{1}{T\alpha} ds.$$

Now, in the general formula (No. XIX. above, p. 143)

$$-\int V\sigma d\alpha = \iint ds V \cdot (VU\nu \nabla) \sigma,$$

put

$$\sigma = \nabla \frac{1}{T\alpha}$$

and we have

$$\begin{aligned} \int \frac{V\alpha d\alpha}{T\alpha^3} &= \iint ds \left( U\nu \nabla^2 \frac{1}{T\alpha} - \nabla S U\nu \nabla \frac{1}{T\alpha} \right) \\ &= \iint ds U\nu \nabla^2 \frac{1}{T\alpha} + \nabla \Omega. \end{aligned}$$

Now the double integral always vanishes while  $T\alpha$  is finite, and we have therefore

$$\delta W = \int \frac{S \cdot \alpha \delta\alpha d\alpha}{T\alpha^3} = S \cdot \delta\alpha \nabla \Omega = -\delta\Omega.$$

\* "Electrodynamics and Magnetism," §§ 5-8, *Anté*, p. 24.

That is, the work done during any infinitesimal displacement of the pole is numerically equal to the change in the value of the spherical angle subtended by the circuit. The angle is, of course, a discontinuous function, its values differing by  $4\pi$  at points indefinitely near to one another, but lying on opposite sides of the uniformly and normally magnetized surface whose edge is the circuit. There is, however, no discontinuity in the value of the work, for the element of the double integral is finite, and equal to  $4\pi$ , when  $T\alpha = 0$ .

Gauss\* says (with date January 22, 1833):—"Eine Hauptaufgabe aus dem *Grenzgebiet der Geometria Situs* und der *Geometria Magnitudinis* wird die sein, die Umschlingungen zweier geschlossener oder unendlicher Linien zu zählen." And he adds that the integral

$$\iint \frac{(x' - x)(dydz' - dzdy') + (y' - y)(dzdx' - dx dz') + (z' - z)(dxdy' - dydx')}{((x' - x)^2 + (y' - y)^2 + (z' - z)^2)^{\frac{3}{2}}},$$

extended over both curves, has the value

$$4m\pi,$$

where  $m$  is the number of linkings (Umschlingungen). This is obviously the same as the integral of  $-\delta W$  above, viz.:-

$$-\iint \frac{S \cdot \alpha d\alpha \delta \alpha}{T\alpha^3},$$

extended round each of two closed curves, of which  $d\alpha$  and  $\delta\alpha$  are elements.

§ 39. A very excellent investigation, by means of Cartesian co-ordinates, will be found in Clerk-Maxwell's *Electricity and Magnetism*, §§ 417—422. It is there shown that the above integral may vanish, even when the circuits are inseparably linked together. In fact  $m$  may vanish either because there is no real linking at all, or because the number of linkings for which the electro-magnetic work is negative is the same as that for which it is positive. For our present application this is of very great consequence, because it shows that the electro-magnetic work, under the circumstances with which we are dealing, cannot in all cases measure the amount of beknottedness. In fact the processes, soon to be described, enable us, without trouble for any given *linkage*, to find the value of  $m$  in Gauss' formula; but there are special ambiguities when we try to apply the process to knots.

§ 40. To construct the magnetized surface which shall exert the same action on a pole as a current in any given closed circuit does, we may either suppose a cylinder extending to infinity in one direction (say for definiteness, upwards from the plane of the paper), and having the circuit for its edge; or we may form, as in the figure, a finite autotomic surface of one sheet, having the circuit for its edge. In dealing with the *two* curves of Gauss' proposition, our procedure is perfectly definite; but when one and the same curve is to be the current and also

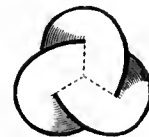

\* *Werke*, Göttingen, 1867, v. p. 605.

the path of the pole, there is an ambiguity in estimating the electro-magnetic work. To clear this away we require a definite statement of how the pole moves along the curve itself. For if its path screw round the curve  $\pm 4\pi$  must be added to the



work for each complete turn. As an illustration, suppose we bend, as in the figure, an india-rubber band coloured black on one side, so that the black is always the concave surface, and so that one loop is the perversion of the other, we find on pulling it out straight that

it has no twist. If both loops be made by *overlying*, when pulled out it becomes twisted through two whole turns. This illustrates the kinematical principle that spiral springs act by torsion. An excellent instance of its connection with knots is to be seen in the process employed in § 11. For if we have portions of a cord, as in the diagram (Plate V. fig. 7), the pulling out of the loop in the upper cord changes the arrangement, as shown in the second figure.

A practical rule, which completely meets the Gaussian problem, may easily be given from the consideration of the cylindrical magnetized surface above mentioned. Go round the curve, marking an arrow-head after each crossing to show the direction



in which you passed it. Then a junction like the following gives  $+4\pi$  for the upper branch, and nothing for the lower (which, on this supposition, does not pass through the magnetic sheet). Change the crossing from *over* to *under*, and this quantity changes sign.

The junction figured above would, in our first illustration, be a silver one. But a still simpler process is to go round, as in § 36 ( $\gamma$ ), putting a dot to the *right* after each crossing *over*, and *vice versa*.

§ 41. Now, in order that our rule when applied to *knots* may give no work where there is no beknottedness, we must make the required expression such as to vanish whenever all the intersections are nugatory. Those which are nugatory only in consequence of their signs are in pairs, silver and copper, and will take care of themselves, as we see by special examples like the following. Hence



the only part to correct for is that depending on the number of whole turns, and the sketch of the india-rubber band above shows that the work at the vertex of each such partial closed circuit is simply not to be counted, *i.e.*, that the  $4\pi$ , which would be reckoned for each such crossing by our rule (positively or negatively as the case may be), is to be considered as made up for by the corresponding screwing of the pole round the curve.

§ 42. There must be some very simple method of determining the amount of beknottedness for any given knot; but I have not hit upon it. I shall therefore content myself with a few remarks on the subject, some of which are general, others applicable only to certain classes of forms. There seems to be little doubt that the difficulty will be solved with ease when the true method of attacking amphicheiral forms is found.

1. To form from a given projection the knot with the greatest amount of beknottedness, it is clear that we must in general so arrange the crossings over and

under as to make *all* the crossings simultaneously silver or copper ones. And when this is done, a projection will give greater beknottedness for the same number of crossings the smaller is the number of crossings which have to be left out of account. Thus the simple *twists* (or clear coils with two turns) are the forms which, with a given amount of knottiness, can have the greatest beknottedness. For in them (see § 41) only one crossing has to be left out of the reckoning. Even a regular plait if of more than two strands cannot have so much beknottedness as it would acquire with the same amount of knottiness if two of its strands were first twisted together, then a third round these, and so on. And thus also entirely nugatory forms like the two first cuts in § 1 can have no beknottedness, for *all* their crossings have to be left out of the reckoning.

As an illustration, take the figure (Plate V. fig. 8) where the supposed number of loops may be any whatever. The free ends must, of course, be joined externally.

If we make the crossings alternately + and - it will be seen at a glance that a change of *one* sign (*i.e.*, that of the extreme crossing at either end) removes the whole knotting; so that there is but one degree of beknottedness. The crossings in this figure are in three rows. Those in the upper row are all copper (the last, of course, becomes silver when its sign is changed), and their number is  $n$  the number of loops. Each of the other rows has  $n-1$ , and all of them are silver. Thus when the one sign is changed there are  $n-1$  copper crossings, and  $2n-1$  silver. By pulling out the right-hand loop we change  $n$  to  $n-1$ , so that one copper and two silver crossings are lost. After  $n-1$  operations like this there remains only one (silver) crossing. It is easy to see from this that the crossings to be omitted in the reckoning of beknottedness (as in § 41) must be the lower row. To prove that it is so, study the beknottedness when the crossings are made so that the upper row are copper, silver, copper, &c., alternately, and those of the two other rows, silver, copper, silver, &c., alternately. It will be easily seen that with five loops there are two degrees of beknottedness, &c., and thus that our rule is correct. It is a curious problem to investigate the torsional and flexural rigidities of a wire bent in this form.

To give the greatest beknottedness to a knot with the same projection, it is obvious that all we have to do is to make the copper crossings into silver ones, *i.e.*, change the sign of each of the upper row of crossings. This gives fig. 9. With five loops it has four degrees of beknottedness.

Another excellent illustration is given by the coils of the class figured in Plate IV. figs. 16 and 17, which have been already described (§ 27). A full investigation of the higher knottinesses of this class (especially when fully beknotted) would well repay the trouble it would involve.

As they are all amphicheiral, and in each case the crossings are divisible into two sets, those of each set being in all respects alike, while those of different sets differ only as to silver or copper, it is no matter (so far as testing beknottedness is concerned) which crossing we suppose to have its sign changed.

In the 8-fold amphicheiral of fig. 16 the change of any one sign reduces the whole to the irreducible trefoil knot (§ 16), right or left-handed according as we have changed one of the four outer, or of the four inner, crossings in the figure. Hence it has *two* degrees of beknottedness. But if we change the signs of one set of crossings (Plate V. fig. 24) so as to make all the crossings alike silver (or copper), we find the knot irreducible, though with continuations of sign; but with *three* degrees of beknottedness. And it is easy to see that it can now be analysed into two right-handed trefoil knots linked together as shown in the other part of the figure. But the linking is *left-handed*. Had it been right-handed we should have had + and - alternately, and thus we could not have transformed back to the form with continuations of sign (§ 4).

Similar remarks apply to the 10-fold amphicheiral plait (Plate IV. fig. 17). Change of any one sign reduces it to the third form of 6-fold knottiness ( $\gamma$ , § 8), which has only one degree of beknottedness. Hence the 10-fold plait has but *two* degrees of beknottedness when its signs are alternate. If we make all its crossings silver (or copper), as in Plate V. fig. 25, it has *four* degrees of beknottedness; and the reason is obvious from the other half of the figure, where it is seen to be made up of a pair of irreducibles—a pentacle and a trefoil, once linked together. There is one degree of beknottedness for the trefoil, one for the link, and two for the pentacle. The trefoil and pentacle are right-handed, the link left-handed, else we should not have had the continuations of sign which the figure must show.

A very curious illustration of this is to be found in the excepted cases, where the number of crossings is a multiple of six. From the two figured (Plate IV. figs. 15, 18) it is obvious that all of these are formed by three unknotted closed curves, *no two of which are linked together*, yet the whole is irreducible, having alternate signs. Hence we require a *third* term to complete our descriptions—knottling, linking, locking (?).

To give the greatest amount of belinkedness to these figures, let us suppose the ovals taken all the same way round, and arrange so that all the crossings shall be silver. Then we have continuations of sign (Plate V. fig. 26) as in the knots of the same series. But whereas Plate IV. fig. 15, if made of wire, is particularly stiff, the new figure is eminently flexible. This seems to have been practically known to the makers of chain armour.

The 9-fold knot of Plate V. fig. 15 has its crossings so drawn as to be all copper. Three must be left out of reckoning for the coiling, so it has *three* degrees of beknottedness.

But if we made the crossings alternately + and - we should find zero for the corrected electro-magnetic work—three copper and three silver crossings remaining. Change, then, the sign of any one of the three outer or inner crossings, and the whole reduces to the 4-fold knot. Hence it has *two* degrees of beknottedness.

If the crossing whose sign is changed be neither an outer nor an inner one, the result is a very singular 8-fold knot (irreducible, though having continuations of



sign), differing from that of fig. 24, Plate V., in the fact that its component trefoil knots are *unsymmetrically* linked together. And it has but *one* degree of beknottedness, while that of fig. 24 has *three*.

I have called attention to this example because of its bearings on the question of *the numbers of different irreducible knots having the same projection*, which we meet with as soon as we reach 8-fold knottiness\*.

2. To remove all beknottedness from a projection it is only necessary to make every crossing in its scheme + (or -) when it is first met with, reading from any point whatever. For then the several laps of the coil are, as it were, paid out in succession one over the other. When the beknottedness of a scheme so marked is calculated (as in § 41), it will be found that there is always at least one choice of a set of crossings such that, when these are omitted from the count, the electro-magnetic work is zero.

As an illustration take the very simplest form, the trefoil knot, with the suffixed signs determined by this rule. The scheme is

$$\begin{array}{cccccc|c} - & + & - & - & + & - & \\ A & C & B & A & C & B & A. \\ + & + & + & - & - & - & + \end{array}$$

Now, by § 41 we are entitled to leave out of count either A, B, or C. Leaving out either A or B gives zero for the electro-magnetic work, as it ought to be; but leaving out C gives  $-8\pi$ .

3. The only way in which we can have the intersections + and - alternately while every letter is + on its first appearance, *i.e.*, when there is no beknottedness, is obviously the wholly nugatory scheme

$$\begin{array}{cccc} A & A & B & B, \text{ \&c.} \\ + & - & + & - \end{array}$$

§ 43. To illustrate these methods let us take again the 5-fold knots (as in § 18) whose schemes are

$$\begin{array}{cccccccc|c} + & + & + & + & + & + & + & + & \\ A & D & B & E & C & A & D & C & E & B & A, \\ - & + & - & + & - & + & - & + & - & + & \\ \\ - & - & - & - & - & - & - & - & - & - & \\ A & D & B & E & C & A & D & B & E & C & A. \\ - & + & - & + & - & + & - & + & - & + & \end{array}$$

The lower signs refer to over or under, the upper to the electro-magnetic work, or to the silver-copper distinction.

Hence to determine the electro-magnetic work we must divide each scheme into independent circuits, no one of which includes a less extensive one; and omit from the reckoning the work for the terminal of each such circuit, and for each of the intersections which is not included in any one of the separate circuits. There are usually more ways than one of doing this. Sometimes these agree in their results;

\* [This very interesting question has since been discussed, for 8-fold and for 9-fold knottiness, by Prof. C. N. Little (*Trans. R. S. E.* xxxv., 1889). 1898.]

but the rule for choosing which to omit is to take them such that *with their proper signs*, and the rest with any signs whatever, they may be capable of making each letter positive on its first appearance. But there are cases even when the knot is not amphicheiral in which this process cannot be carried out. These occur specially when a part of the knot forms a lower knot with which the string is again linked.

In the first of the two schemes above there is but one independent non-automatic circuit, which may be taken as

A D B E C A.

In this all the intersections are included, so that the whole work is to be found by leaving out that for A only; *i.e.*, it is  $-16\pi$ .

But in the second scheme we may take the two circuits

B A D B and C A D C,

and E is not included in either. Hence we must leave out of count the work for B, C, and E. This is found to satisfy our test, and thus the whole work is only  $-8\pi$ .

This is an instance in which the estimate by the electro-magnetic process exactly agrees with the result of simpler considerations, as given in § 35 above.

§ 44. It will be found that the alteration of five signs is sufficient to remove the knotting from the annexed figure, and the stages of operation of the various modes of reduction show that this form can be regarded as made up of simpler knots intersecting one another on the same string. These separate knots are virtually independent, and to change *all* the signs in any one of them does not in cases like this necessarily simplify the knot. Uncorrected the work is  $-13 \times 4\pi$ . Corrected it is  $-10 \times 4\pi$ , which agrees with the removal of the beknottedness by change of *five* signs only.

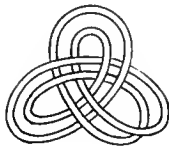

If the sign of the one unsymmetrical crossing be altered, four changes of sign will suffice; for the uncorrected work is  $-11 \times 4\pi$ ; corrected it is  $-8 \times 4\pi$ , corresponding to four changes of sign.

§ 45. It is clear from what precedes that the Gaussian integral does not, except in certain classes of cases, express the measure of what may be called, by analogy with § 35, *Belinkedness*. It may be well to examine a simple form of link with all its possible arrangements of sign to see what the integral really gives in each of these. Let us choose for this purpose two lemniscates having four mutual crossings, suggested by the edges of the band shown in fig. 13, Plate IV.

If we suppose the signs to be made alternately + and -, as in Plate V. fig. 10, the form is a six crossing one, and irreducible. The silver or copper character of the *self* crossings does not depend upon the directions in which we suppose the lemniscates to be described, that of the *mutual* crossings does. We thus have, from another

point of view than that of § 41, a proof that these are to be left out of account in the reckoning.

The four crossings of the *two* curves are copper, if these curves are supposed to be described in the same way round; those of the separate curves (which do not count) are silver. Hence the work is  $-16\pi$ , or two degrees of belinkedness.

Change the sign of any *one* of P, Q, R, S, that and the adjacent one slip off, U and V become nugatory. The linkage is the simplest possible, and the integral is  $8\pi$ .

Change the sign of either or both of U and V. In either of these three cases both become nugatory, and the whole takes the form of two doubly-linked ovals, with the integral =  $-16\pi$ . (Plate V. figs. 12, 13.)

If the signs of both R and S be changed the value of the integral is obviously  $4(2-2)\pi$ , for R and S have become silver, while P and Q remain copper.

If in addition the signs of U and V be both, or neither, changed, only one crossing is got rid of, and the link may be put in the form (Plate V. fig. 14). It cannot be farther reduced, because the crossings are alternately over and under.

But if the sign of one only of U, V be changed, it will be seen that there is no linking (Plate V. fig. 11). Here the integral vanishes because there is really *no work*, not as in the last case, where there are *equal amounts of positive and negative work*.

§ 46. This gives a hint as to the reckoning of beknottedness from the silver and copper crossings in the cases where we have found a difficulty. After omitting from the reckoning the crossings which belong merely to the *outline* of the figure, there must remain an *even* number of crossings (§ 22). Hence, whatever numbers be silver and copper respectively, the excess of the one of these over the other must be an even number (zero included). In general, *half this number is the beknottedness*. But when the knot, or even part of it, is amphicheiral there is usually more beknottedness than this rule would give. And, in particular, there may be beknottedness when the number is zero. In this case the number of silver (and of copper) crossings is even, and is double the degree of beknottedness.

As I have already stated, I have not fully investigated this point, and therefore for the present I content myself with giving two instructive examples from the six-fold knots. The observations which will be made on these contain at least the germ of the complete solution.

The form  $\gamma$  (of § 8) is not amphicheiral. As there drawn, it has four copper and two silver crossings, the latter being the intersections of the loop with the trefoil; but the scheme shows that two copper crossings must be omitted from the reckoning, one of these being necessarily that which is uppermost in the figure. If the sign of this last be changed, the knot opens out, so that it has but one degree of beknottedness. Hence, in this case, the two copper and two silver crossings correspond to one degree

of beknottedness only. But if we change the sign of *any one* of the other three copper junctions the knot sinks to the 4-fold amphicheiral, retaining its one degree of beknottedness.

In the amphicheiral form  $\beta$  (of § 8) there are three silver and three copper crossings. As the figure is drawn, these are to the right and left of the figure respectively; and either crossing at the end of the lower coil may be left out, along with any one of the three on the other side. Thus there remain, as in the former case, two silver and two copper ones. This corresponds to one degree of beknottedness, as in the last case, for the change of sign of *either* crossing at the end of the lower coil unlooses the knot. But if any one of the other four crossings (alone) have its sign changed, the whole becomes a right or left-handed trefoil knot, retaining, as in the former example, its one degree of beknottedness.

To give the greatest beknottedness to these forms, we must alter two signs in ( $\gamma$ ) and three in ( $\beta$ ). In each case one crossing is lost, and the form becomes the pentacle (§ 7) with its two degrees of beknottedness.

## PART V.

### *Amphicheiral Forms.*

§ 47. These have been defined in § 17, and several examples have been given, not only of knots, but of links, which possess the peculiar property of being transformable into their own perversions.

The partition method (§ 21) suggests the following mode of getting amphicheirals:— Since the right-handed and left-handed compartments must agree one by one, and since (§ 20) the whole number of compartments is greater by two than the number of crossings, the number of crossings must be even. Let it be  $2n$ , and let  $p_1, p_2, \dots, p_{n+1}$  be the partitions. Then our selection must be made from the numbers which satisfy

$$p_1 + p_2 + \dots + p_{n+1} = 4n,$$

no one being greater than the sum of the others. If a set of such can be grouped as in § 20 so that the other set for the complete scheme shall be the same numbers *with the same grouping*, we have an amphicheiral form. The words in italics are necessary, as the following example shows; for here the black and white compartments have the same set of partitions but not the same grouping, and the knot is not amphicheiral:—

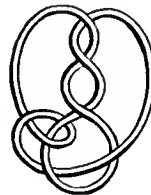

But a different grouping of the *same* set of partitions gives the amphicheiral form below

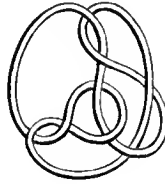

But an easier mode of procedure, though even more purely tentative, is the following:—If a cord be knotted, any number of times, according to the pattern below,

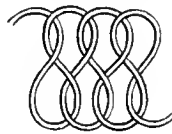

it is obviously *perverted* by simple *inversion*. Hence, when the free ends are joined it is an amphicheiral knot. Its simplest form is that of 4-fold knottiness. All its forms have knottiness expressible as  $4n$ .

The following pattern gives amphicheiral knottiness  $2 + 6n$ :—

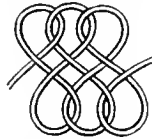

And a little consideration shows that on the following pattern may be formed amphicheiral knots of all the orders included in  $6n$  and  $4 + 6n$ :—



Among them these forms contain all the even numbers, so that *there is at least one amphicheiral form of every even order.*

Many more complex forms may easily be given. See, for instance, Plate V. figs. 18, 19, 20. Some are closely connected with knitting, &c.

An excessively simple mode of obtaining such to any desired extent is to start with an amphicheiral, whether knot or link, and insert additional crossings. These must, of course, be inserted symmetrically in pairs, each in the original figure being accompanied by another which will take its place in the perversion or image.

Thus, taking the simplest of all amphicheirals, the single link (Plate V. first of figures 27), we may operate on it by successive steps as in the succeeding figures.

The second, third, and fourth are formed from the first by adding, the fifth and sixth from the fourth by removing, pairs of crossings. The third, like the first, is a link; the others are knots.

Figures 28, Plate V., give another series, of which the genesis is obvious. The protuberances put in the first figure, for instance, show how it becomes the second. The fifth of fig. 27, and the second and fourth of fig. 28, all alike represent the amphicheiral form ( $\beta$ ) of § 8. But we need not pursue this subject.

§ 48. It will be seen at a glance that the first pattern in last section gives for two loops (*i.e.*, four crossings) the knot of § 6; while the third pattern as drawn is simply  $\beta$  of § 8. In this form of the knot, the two dominant crossings (§ 46) are those in the middle, and mere inspection of the figures shows that the whole knotting becomes nugatory if the sign of either of these be changed.

It might appear at first sight that amphicheirals of the same knottiness, formed on such apparently different patterns as the two first of last section, would be necessarily different. But the very simplest case serves to refute this notion. For the lowest integers which make

$$4n = 2 + 6n'$$

give 8 as the value of either side. Figs. 22, 23, Plate V., represent the corresponding amphicheirals, apparently very different, but really transformable into one another by the processes of § 11. Fig. 21, Plate V., represents another 8-fold amphicheiral form, suggested by a somewhat similar pattern. I hope to return to the consideration of this very curious part of the subject, and at the same time to develop a method of treating knots altogether different from anything here given, which I recently described to the Society\*.

After the papers, of which the foregoing is a digest, had been read, I obtained from Professors Listing and Klein a few references to the literature of the subject of knots. It is very scanty, and has scarcely any bearing upon the main question which I have treated above. Considering that Listing's Essay was published thirty years ago, and that it seems to be pretty well known in Germany, this is a curious fact. From Listing's letter (*Proc. R. S. E.* 1877, p. 316), it is clear that he has published only a small part of the results of his investigations. Klein† himself has made the very singular discovery that *in space of four dimensions there cannot be knots*.

The value of Gauss' integral has been discussed at considerable length by Boeddicker (by the help of the usual co-ordinates for potentials) in an Inaugural Dissertation, with the title, *Beitrag zur Theorie des Winkels*, Göttingen, 1876‡.

\* *Proceedings R.S.E.*, May 7th, 1877.

† *Mathematische Annalen*, ix. 478.

‡ Professor Fischer has just shown me an enlarged copy of Boeddicker's pamphlet above mentioned. Twenty pages are now added, mainly referring to the connection of knots with Riemann's surfaces, and the title is altered to *Erweiterung der Gauss'schen Theorie der Verschlingungen*, Stuttgart, 1876.

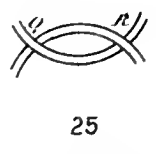
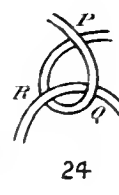
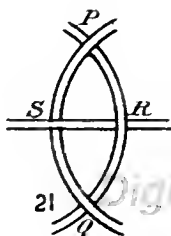
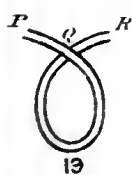
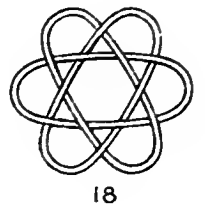
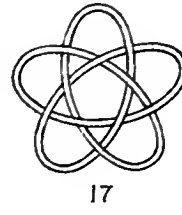
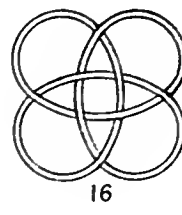
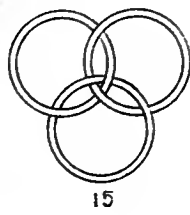
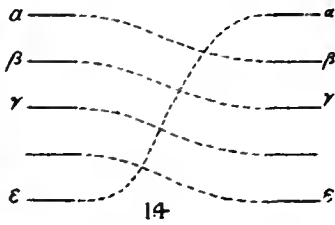
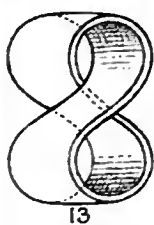
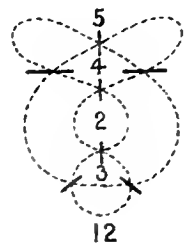
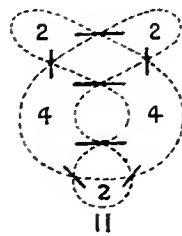
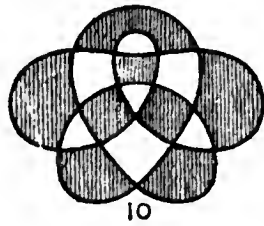
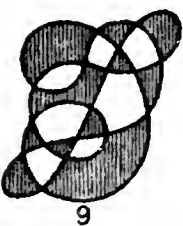
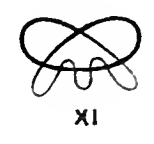
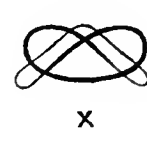
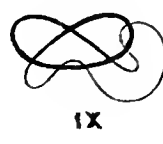
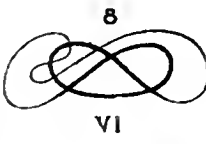
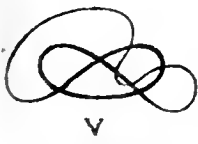
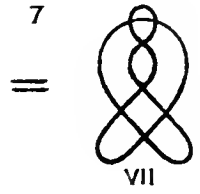
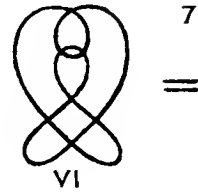
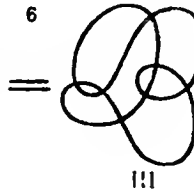
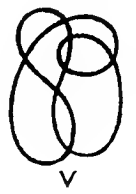
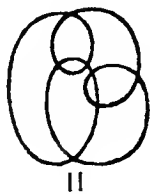
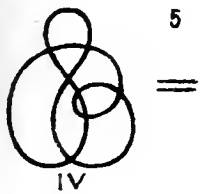
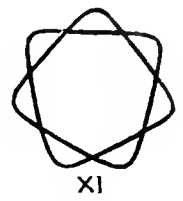
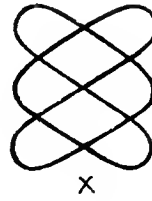
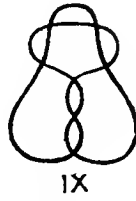
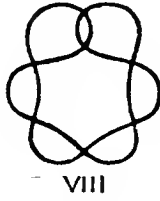
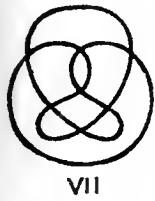
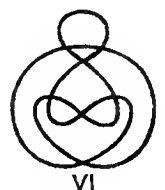
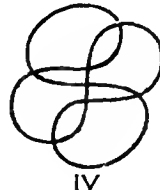
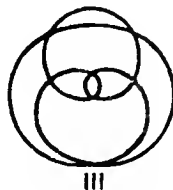
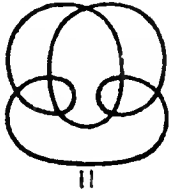
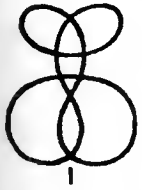
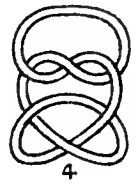
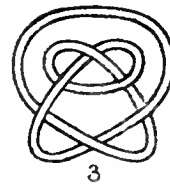
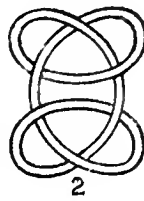
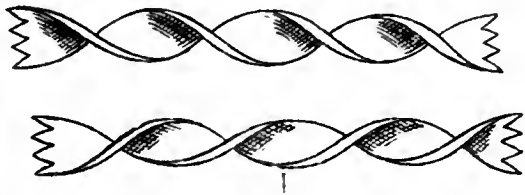





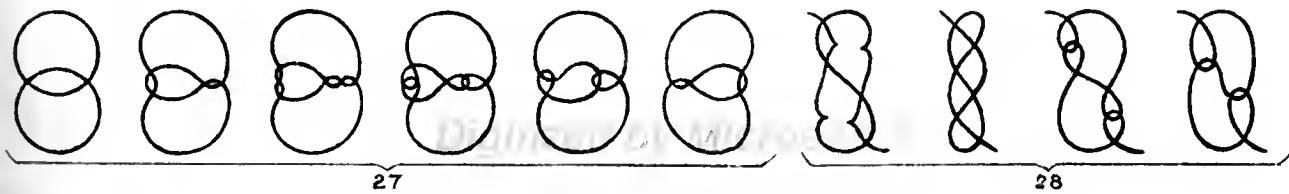
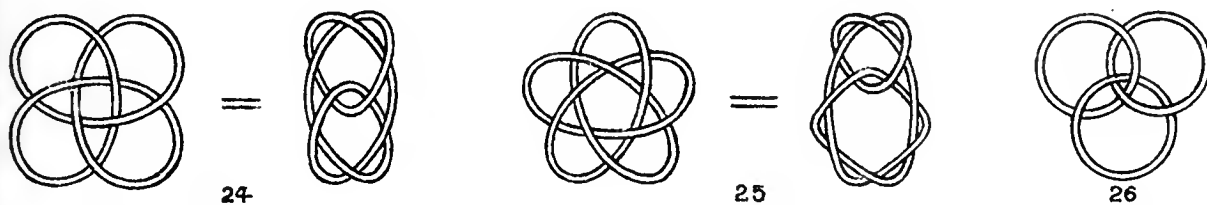
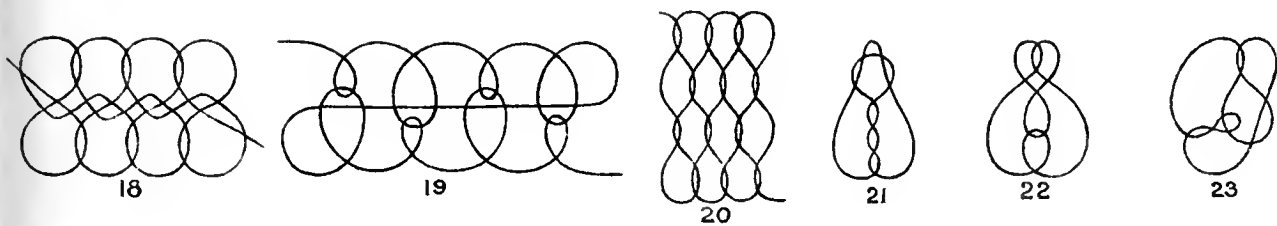
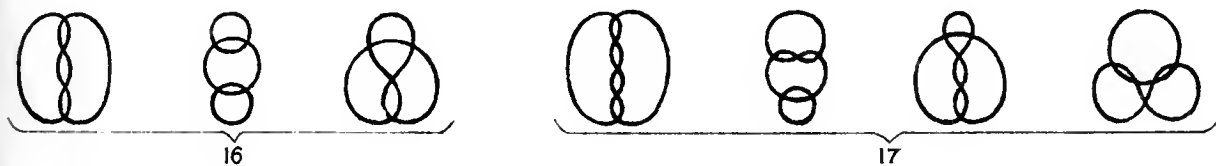
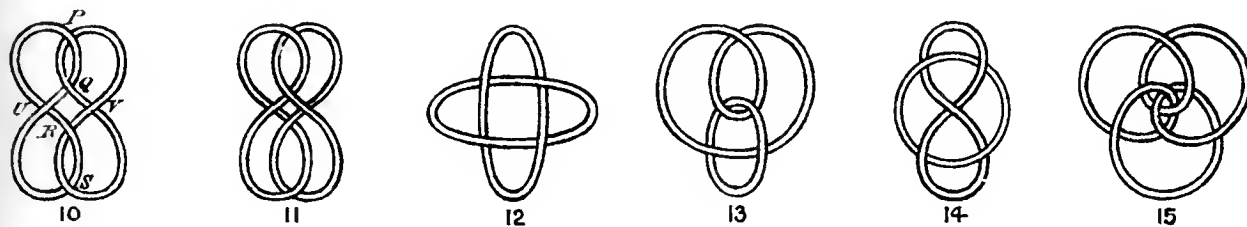
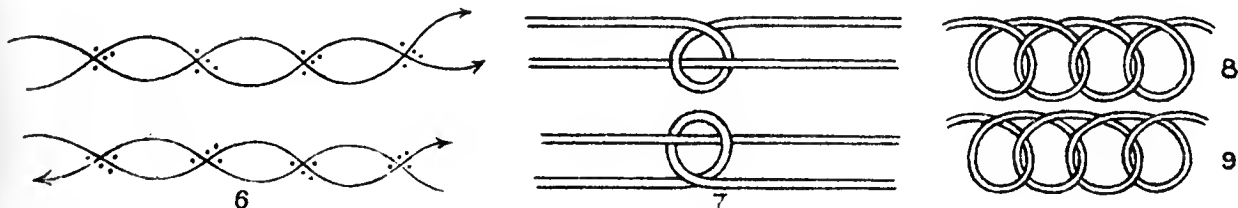
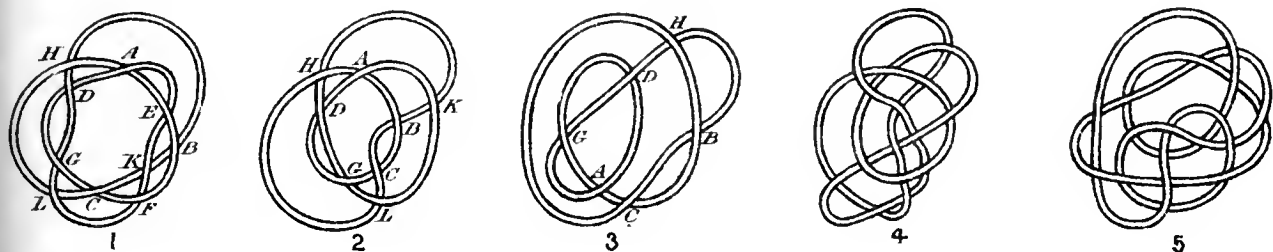



An Inaugural Dissertation by Weith, *Topologische Untersuchung der Kurven-Verschlingung*, Zürich, 1876, is professedly based on Listing's Essay. It contains a proof that there is an infinite number of different forms of knots! The author points out what he (erroneously) supposes to be mistakes in Listing's Essay; and, in consequence, gives as something quite new an illustration of the obvious fact that there can be irreducible knots in which the crossings are not alternately over and under. The rest of this paper is devoted to the relations of knots to Riemann's surfaces.

## XL.

## ON KNOTS. PART II.

[*Transactions of the Royal Society of Edinburgh*, Vol. XXXII. Read 2nd June, 1884.]

ONE main object of the present brief paper is to take advantage of the results obtained by Kirkman\*, and thus to extend my census of distinct forms to knottiness of the 8th and 9th orders; for the carrying out of which, by my own methods, I could not find time. But I employ the opportunity to give, in a more extended form than that in the short abstract in the *Proceedings*, some results connected with the general subject of knots, which were communicated to the Society on January 6, 1879, as well as others communicated at a later date, but not yet printed even in abstract.

I. *Census of 8-Fold and of 9-Fold Knottiness.*

1. The method devised and employed by Kirkman is undoubtedly much less laborious than the thoroughly exhaustive process (depending on the *Scheme*) which was fully described and illustrated in my former paper†; but it shares, with the *Partition* method, which I described in § 21 of that paper and to which it has some resemblance, the disadvantage of being to a greater or less extent tentative. Not that the rules laid down, either in Kirkman's method or in my partition method, leave any room for mere guessing, but that they are too complex to be always completely kept in view. Thus we cannot be absolutely certain that by means of such processes we have obtained all the essentially different forms which the definition we employ comprehends. This is proved by the fact that, by the partition method, I detected certain omissions in Kirkman's list, which in their turn enabled him to discover others, all of which have now been corrected. And, on this ground, the present census may still err in defect, though such an error is now perhaps not very probable.

\* The Enumeration, Description, and Construction of Knots with fewer than Ten Crossings. *Trans. R.S.E.* XXXII.

† No. XXXIX. above.

On the other hand, the treatment to which I have subjected Kirkman's collection of forms, in order to group together all mere varieties or transformations of one special form, is undoubtedly still more tentative in its nature; and thus, though I have grouped together many widely different but equivalent forms, I cannot be *absolutely* certain that all those groups are essentially different one from another.

Unfortunately these sources of possible error, though they tend (numerically) in opposite directions, and might thus by chance compensate one another so far as to make the assigned numbers of essentially different forms accurate, cannot in any other sense compensate. In other words, there may still be some fundamental forms omitted, while others may be retained in more than one group of their possible transformations. Both difficulties grow at a fearfully rapid rate as we pass from one order of knottiness to the next above; and thus I have thought it well to make the most I could of the valuable materials placed before me; for the full study of 10-fold and 11-fold knottiness seems to be relegated to the somewhat distant future.

2. The problem which Kirkman has attacked may, from the point of view which I adopt, be thus stated:—"Form all the essentially distinct polyhedra\* (whether solids, quasi-solids, or unsolids) which have three, four, &c., eight, or nine, four-edged solid angles." Thus, in his results, there is no fear of encountering two different projections of the same polyhedron; or, in the language of my former paper, no two of his results will give the same scheme. Thus there is no one which can be formed from another by the processes of § 5 of my former paper.

3. But, when a projection of a knot is viewed as a polyhedron, we necessarily lose sight of the changes which may be produced, by *twisting*, in the knot itself when formed of cord or wire; a process which (without introducing nugatory crossings) may alter, often in many ways, the character of the corresponding polyhedron. This subject was treated in §§ 4, 11, 14, &c. of my former paper. But it is so essential in the present application that it is necessary to say something more about it here. It would lead to great detail were I to discuss each example which has presented itself, especially in the 9-folds; but they can all be seen in Plate VI., by comparing together two and two the various members of each of the groups.

The following example, however, though one only of several possible transformations is given, is sufficiently general to show the whole bearing of the remark, so far at least as we at present require it.

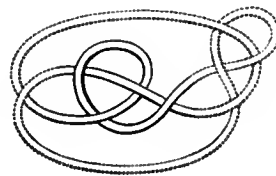
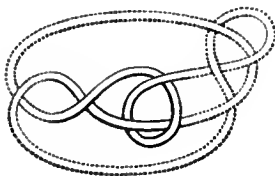

\* This word is objectionable, on many grounds, in the present connection. But a more suitable one does not occur to me; and the qualification (given in brackets) will prevent any misconception. Of course no projection of a *true* polyhedron can be cut by a straight line in two points only.

It is obvious that either figure may be converted into the other, by merely rotating through two right angles the part drawn in full lines, the dotted part of the cord being held fixed. Also, the numbers of corners or edges in the right and left-handed meshes in these two figures are respectively as below:—

$$\begin{array}{ccc} 55332 & & 64332 \\ 443322 & \text{and} & 433332. \end{array}$$

These numbers would necessarily be *identical* if the forms could be represented by the same scheme. As will be seen by the list below, § 6, these are respectively the second, and the sixth, of the group of equivalent forms of number VIII of the ninefold knots. (See Plate VI.)

The characters of the various faces of the representative polyhedra (so far at least as the number of their sides is concerned) are widely different in the two cases. [Mr Kirkman objects to this process that it introduces twisting of the cord or tape *itself*. No doubt it does, or at least seems to do so, but the algebraic sum of all the twists thus introduced is always zero; *i.e.*, by “ironing out” the tape in its new form, all this twist will be removed. I have often used a comparison very analogous to this, to give to students a notion of the nature of the kinematical explanation of the equal quantities of + and – electricity, which are always produced by electrification. If the two ends of a stretched rope, along whose cylindrical surface a generating line is drawn, be fixed, and torsion be applied to the middle by means of a marlinspike passed through it at right angles, one half of the generating line becomes a right-handed, the other an equal left-handed cork-screw. Thus the algebraic sum of the distortions is zero. And, in consequence, if the rope be untwistable (the *Universal Flexure Joint* of § 109 of Thomson and Tait’s *Natural Philosophy*) and endless, the turning of the spike merely gives it rotation like that of a vortex-ring. Such considerations are of weighty import in many modern physical theories.]

As will be seen, by an examination of the latter part of Plate VI., even among the forms of 9-fold knottiness there are several which are capable of more than one different changes of this kind. Some of these I may have failed to notice. But it is worthy of remark that the 8-folds seem, with two exceptions, to resemble the 7-folds in having at most two distinct polyhedral forms for any one knot.

4. Kirkman’s results for knottiness 3, 4, 5, 6, 7, when biflars and composites are excluded, agree exactly with those given in my former paper. I have figured these afresh in Plate VI., in the forms suggested by Kirkman’s drawings, omitting only the single 6-fold, and the single 7-fold, which are composite knots.

As will be seen in the Plate, where they are figured in groups, there are but 18 simple forms of 8-fold knottiness. Besides these there are 3 not properly 8-fold, being composite (*i.e.*, made up of two *separate* knots on the same string); either two of the unique 4-fold, or a trefoil with one or other of the two 5-folds. These it was not thought necessary to figure, especially as they may present themselves in a variety of forms.

And the Plate also shows that there are 41 simple forms of 9-fold knottiness. Besides these, and not figured, there are 5 made up of two mere separate knots of lower orders, and one which is made up of three separate trefoils.

5. Thus the distinct forms of each order, from the 3rd to the 9th inclusive, are in number

$$1, 1, 2, 4, 8, 21, 47;$$

or, if we exclude combinations of separate knots,

$$1, 1, 2, 3, 7, 18, 41.$$

The later and larger of the numbers in these series, however, would be considerably increased if we were to take account of arrangements of sign at the crossings, other than the alternate over and under which has been tacitly assumed; for these are, in certain cases, compatible with non-degradation of the order of knottiness. This raises a question of considerable difficulty, upon which I do not enter at present. Applications to one of the 8-folds and to one of the 9-folds will be found in my former paper, § 42 (1).

Another interesting fact which appears from Plate VI. is, that there are six distinct amphicheiral forms of 8-fold knottiness: at least if we include one, not figured, which consists of two separate 4-folds; in which case we must consider that there are two six-fold amphicheirals, the second being the combination of right and left-handed trefoils, described in § 13 of my former paper. Thus the number of amphicheirals is, in the 4-fold, 6-fold, and 8-fold knots respectively, either 1, 2, 6, or (if we exclude composites), 1, 1, 5. All but two of these 8-fold amphicheirals were treated in my former paper, two having been separately figured, and the other being a mere common case of the general forms of § 47.

Finally, as a curious addition to the paragraphs on the genesis of amphicheiral knots, given in my first paper, I mention the following, which is at once suggested by the amphicheiral 6-fold:—Keeping one end of a string fixed, make a loop on the other; pass the free end through it and across the fixed end; pass the free end again through the external loop last made, then across the fixed end, and so on indefinitely. The second time the fixed end is reached we have the trefoil (if the alternate over and under be adhered to), the third time we have the amphicheiral 6-fold; and, generally, the  $n$ th time, a knot of  $3(n-1)$  fold knottiness, which is amphicheiral if  $n$  is odd. Three of these were, incidentally, given in my former paper.

But, reverting to the main object of my former paper, we now see that the distinctive forms of less than 10-fold knottiness are together more than sufficient (with their perversions, &c.) for the known elements, as on the Vortex Atom Theory.

6. From the point of view of theory, as suggested in §§ 12, 21, of my former paper, it may be well to give here the partitions of  $2n$  which correspond to true knots—for the values of  $n$  from 3 to 9 inclusive. The various partitions, subject to the proper conditions, are all given, in the order of the number of separate parts in each; those

which have a share in one or more of the true knots, as given in the Plate, are printed in larger type.

$n = 3$	$n = 6$ (contd.)	$n = 8$ (contd.)	$n = 9$	$n = 9$ (contd.)
<b>33</b>	42222	<b>772</b>	<b>99</b>	<b>66222</b>
<b>222</b>	<b>33222</b>	<b>763</b>	972	<b>65322</b>
	222222	<b>754</b>	963	<b>64422</b>
		664	954	<b>64332</b>
$n = 4$	$n = 7$	<b>655</b>	<b>882</b>	<b>63333</b>
		8422	873	<b>55422</b>
44	<b>77</b>	8332	<b>864</b>	<b>55332</b>
422	752	7522	855	<b>54432</b>
<b>332</b>	743	7432	774	<b>54333</b>
2222	<b>662</b>	7333	765	<b>44442</b>
	653	6622	<b>666</b>	<b>44433</b>
	<b>644</b>	<b>6532</b>	9522	822222
	554	6442	9432	732222
$n = 5$	7322	<b>6433</b>	9333	642222
	6422	<b>5542</b>	8622	633222
<b>55</b>	6332	5533	8532	<b>552222</b>
532	<b>5522</b>	<b>5443</b>	8442	<b>543222</b>
<b>442</b>	<b>5432</b>	4444	8433	<b>533322</b>
433	<b>5333</b>	82222	<b>7722</b>	444222
4222	4442	73222	<b>7632</b>	<b>443322</b>
<b>3322</b>	<b>4433</b>	64222	<b>7542</b>	<b>433332</b>
<b>22222</b>	62222	63322	<b>7533</b>	<b>333333</b>
	53222	<b>55222</b>	<b>7443</b>	6222222
	<b>44222</b>	<b>54322</b>	6642	5322222
	<b>43322</b>	<b>53332</b>	<b>6633</b>	<b>4422222</b>
	<b>33332</b>	<b>44422</b>	<b>6552</b>	<b>4332222</b>
66	422222	<b>44332</b>	<b>6543</b>	<b>3333222</b>
642	<b>332222</b>	<b>43333</b>	6444	42222222
633	<b>2222222</b>	622222	<b>5553</b>	<b>33222222</b>
<b>552</b>		532222	<b>5544</b>	<b>222222222</b>
<b>543</b>		442222	93222	
444	$n = 8$	<b>433222</b>	84222	
6222		<b>333322</b>	83322	
5322	88	4222222	75222	
4422	862	<b>3322222</b>	74322	
<b>4332</b>	853	22222222	73332	
3333	844			

The whole numbers of available partitions are thus in order:—

2, 4, 7, 14, 23, 40, 66.



Of these there are employed for knots proper only

2, 1, 4, 4, 12, 17, 36,

respectively. The remainder give links, or composite knots, or combinations of these. (See *Appendix*.)

To enable the reader to identify, at a glance, any knot of less than 10-fold knottiness, I subjoin the partitions corresponding to each figure in Plate VI. It is to be remembered that (as in § 15 of my former paper) deformations which are compatible with the *same scheme*, however they may change the appearance of a knot, do not alter the partitions. But it is also to be remembered that identity of partitions, alone, does not necessarily secure identity of form.

The 3, 4, 5, and 6-folds may be disposed of in a single line.

$n = 3$	$n = 4$	$n = 5$	$n = 6$
33	$\overline{332}$	442    55	543    552
$\overline{222}$		3322 ,    22222	$\overline{4332}$ ,    33222 ,    33222

Here the bar indicates not only that the right and left-handed partitions are alike in number and value, but also that they are similarly connected, *i.e.*, that the knot is amphicheiral.

For the Sevenfolds, we have

<p>I.</p> <p>5333    4433 43322    or    43322</p>	<p>II.</p> <p>5432    5432 43322    or    33332</p>	<p>III.</p> <p>5432    4433 44222    or    44222</p>	
<p>IV.</p> <p>644 332222</p>	<p>V.</p> <p>5522 44222</p>	<p>VI.</p> <p>662 332222</p>	<p>VII.</p> <p>77 2222222</p>

For the Eightfolds,

<p>I.</p> <p><math>\overline{44332}</math></p>	<p>II.</p> <p>54322    54322    54322 53332    or    44332    or    43333</p>	<p>III.</p> <p>53332    44332 44422    or    44422</p>	
<p>IV.</p> <p>5443 333322</p>	<p>V.</p> <p>54322    54322 44332    or    <math>\overline{54322}</math>    or    <math>\overline{44332}</math></p>	<p>VI.</p> <p>6532    6532 333322    or    433222</p>	<p>VII.</p> <p><math>\overline{43333}</math></p>
<p>VIII.</p> <p>6433    5443 433222    or    433222</p>	<p>IX.</p> <p>5542    54322 433222    44332</p>	<p>X.</p> <p>54322    54322 44332    or    54322</p>	<p>XI.</p> <p>55222    55222 44332    or    54322</p>

XII.	XIII.	XIV.	XV.	XVI.	XVII.	XVIII.
	6532	655	763	754		772
<u>54322</u>	433222	3322222	3322222	3322222	<u>55222</u>	3322222

Finally, for the Ninefolds, the list is

I.	II.					
44433	63333	63333	54333	54333	44433	44433
433332	533322	or 443322	or 533322	or 443322	or 533322	or 443322
III.	IV.					
54333	44433		54432	54432	54432	54432
443322	or 443322		533322	or 533322	or 443322	or 443322
V.	VI.	VII.				
44442	64332	55332	64332	[ 55332 ]*	54432	54432
443322	443322	or 443322	or 443322	[ or 443322 ]	433332	or 433332
VIII.						
	64332	55332	64332	55332	55332	64332
	443322	or 443322	or 533322	or 533322	or 433332	or 433332
IX.	X.	XI.	XII.			
54432	5553	5544	64422	64422	64422	64422
443322	3333222	3333222	433332	or 333333	or 533322	or 443322
XIII.	XIV.					
55422	55422	55422	65322	65322	65322	65322
443322	or 533322	or 433332	433332	or 433332	or 533322	or 443322
XV.	XVI.					
65322	55332	55332	65322	7632	7632	7632
443322	or 443322	or 543222	or 543222	3333222	or 3333222	or 4332222
XVII.	XVIII.					
64332	64332	54432	54432	64332	54333	54432
533322	or 443322	or 533322	or 443322	543222	or 543222	or 543222
XIX.						
XX.						
	55422	55422	55332	54432	54432	
	533322	or 443322	543222	or 543222	or 543222	

\* [See Part III. below, § 20, p. 344; and fig. L, pl. VII. 1898.]

XXI.

7443      7443      6543      6543      7533      6633      7533      6633  
 4332222 or 3333222 or 3333222 or 4332222      4332222 or 4332222 or 3333222 or 3333222

XXII.

XXIII.

6543      5553      6552      6552      64422      44442      44442      64422  
 4332222 or 4332222      4332222 or 3333222      443322      543222 or 443322 or 543222

XXIV.

XXV.

XXVI.

66222      66222      66222      5544      6543      7533      6543  
 443322 or 543222 or 443322      4422222 or 4422222      4332222 or 4332222

XXVII.

XXVIII.

XXIX.

64422      64422      7542      7542      65322      55332  
 543222 or 443322      4332222 or 3333222      543222 or 543222

XXX.

XXXI.

XXXII.

44442      64422      7632      6633      7542      5544      44433  
 552222 or 552222      4422222 or 4422222      4422222 or 4422222      333333

XXXIII.

XXXIV.

XXXV.

XXXVI.

666      864      882      66222      7722      99  
 33222222      33222222      33222222      552222      4422222      22222222

XXXVII.

XXXVIII.

XXXIX.

XL.

XLI.

It will be seen that the above list suggests many curious remarks. Thus, in the eightfolds, we have two *different* amphicheirals, each having the partitions  $\overline{44332}$ . Again, we have  $\overline{54322}$  for a knot which is not amphicheiral, as well as  $\overline{54322}$  for one which is amphicheiral. (See § 47 of my former paper.) And we have  $\overline{54322}$  standing  $\overline{44332}$  for two quite distinct knots. All these apparent difficulties, however, are due to the incompleteness of the definition by partitions *merely* (*i.e.*, as by Listing's Type-Symbol). For, in addition to this, it is requisite that we should know the relative grouping of the right-handed or of the left-handed partitions.

In the Plate I have inserted the designations given in my former paper to the various forms of 6-fold and 7-fold knottiness:—and I have also appended to each form the designation of the corresponding figure in Kirkman's drawings.

The Plate contains a great deal of information of a kind not yet alluded to in this paper. It gives, for instance, an excellent set of examples of *Knottfulness*. This term implies (§ 35 of my former paper) "*the number of knots of lower orders (whether interlinked or not) of which a given knot is built up.*" It is to be understood as applied

to *simple* forms only; for we have set aside, as *composite* knots, all such as have any one component separable, so that it may be drawn tight without fastening together two laps belonging to one or two of the other components.

Thus, as a few of the examples of 2-fold knotfulness among the 8-folds, we have

VI. and XI. (3-fold and once-beknotted 5-fold);

and II. and V. (each two 4-folds); while

III., IX., and XIV. are different forms of two (linked) 3-folds.

Among the 9-folds we have, for instance,

XXX. and XXXIII. (4-fold and clear coiled 5-fold),

XVI. and XXVI. (3-fold and  $\delta$  6-fold),

XIV., XV., XVIII., and XXV. (4-fold and once-beknotted 5-fold).

But we have also

IV., XIII., XXIII., and XXIV. (linked 3-fold and 4-fold),

XX., XXVII. (two 3-folds, linked, and with one kink).

The analysis of self-locked knots, such as IV. and VII. of the 8-folds, and II., IX., X., XIX., &c., of the 9-folds, is considered below.

## II. *Beknottedness.*

7. The question of *Beknottedness* (on which I have occasionally made short communications to the Society since my papers of 1876-7 were printed in a brief condensed form) has been again forcibly impressed on me while endeavouring to recognise identities among Kirkman's groups. I still consider that its proper measure is *the smallest number of changes of sign which will remove all knottiness*. But, shortly after my former paper was published, I was led to modify some ideas on the subject, which were at least partially given there. I had been so much impressed by the very singular fact of the existence of amphicheiral forms, that I fancied their properties might in great measure explain the inherent difficulties of this part of the subject. I have since come to see that this notion was to some extent based on an imperfect analogy, due to the properties of the 4-fold amphicheiral, and that the true difficulty is connected with *Locking*.

8. The existence and nature of this third method of entangling cords were first made clear to me by one of the random sketches which I drew to illustrate Sir W. Thomson's paper on *Vortex-Motion* [*Trans. R. S. E.*, 1867-8]. I had not then even imagined that the crossings in any knot or linkage could *always* be taken alternately over and under, though I found that I could make them so in all these sketches. The particular figure above referred to again presented itself, among others possessing a similar character, while I was studying the peculiar group of plaited knots

whose schemes contain the lettering in alphabetical order in the even as well as in the odd places. (See §§ 27, 42, of my former paper.) But I soon saw that, though I had first detected locking in those members of the group of plaits where *three* separate strings are involved, essentially the same sort of thing occurs in the other members of the group, though they are also proper knots in the sense of being each formed

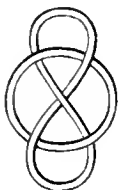

with a *single* continuous and endless string. And, as the above very simple example sufficiently shows, we can have locking, independent of either knotting or linking, with *two* separate strings. For it is clear that the irreducibility of this combination depends solely upon the sign of the *central* crossing. There is no real linking of the two cords, and there is obviously no knotting. But if the sign of any one of the crossings, except the central one, be changed, the whole becomes the simple amphicheiral link, the linking having been *introduced* by the change of sign. [This, as will be seen in § 14 below, is an excellent example of a case in which the key-crossing of a locking is also a root-crossing of a fundamental loop.]

9. We may therefore define, as one degree of locking, any arrangement, or independent part of an arrangement, analogous to that above (whether it be made of one, two, or three separate strings), the criterion being that the change of one sign unlocks the whole. But it is well to notice, again, that if, in the above figure, we change the sign of any crossing except the central one, we have one degree of linking left, and that this has in reality been *introduced* by the change of sign. This remark extends, with few exceptions, to more complex cases.

10. Thus, though the following 8-fold knot (which I reproduce from No. XXXIX. above, § 47, p. 314) does not, at first sight, appear to depend on locking, we have only to



make a simple transformation (as *ante*, § 3) to reduce it to the symmetrical form in which the single degree of locking is at once evident. It was by considering this knot,

with its (quite unexpected) single degree of beknottedness, that I first saw the true bearing of locking in the present subject. (It is given as x. of the 8-folds in Plate VI.)

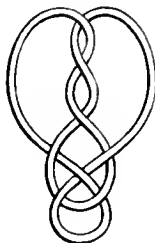

Other excellent instances of the same difficulty are the following. The first of these is completely resolved, the second changed to the 3-fold, while the third becomes apparently two linked trefoils, all by the change of the single crossing in the middle of the lock. But with the 9-fold knot (which is merely a different projection of Plate VI., fig. xxxv.) the trefoils are so linked after this operation, that the change of sign of one crossing of either resolves the whole. This is, however, much more easily seen

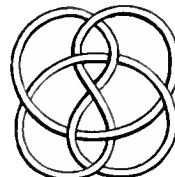
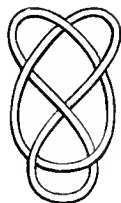

by at once changing the signs of the middle and of the lower (or the upper) crossing, for the whole is thus resolved. [This course is at once pointed out by the process of § 13 below, if we choose as *fundamental* crossings the three highest in the figure.] Hence the beknottedness is 1, 2, 2 in the last three figures respectively.

11. Another instructive example is afforded by the 8-fold knot below, which is figured as IV. on Plate VI.:

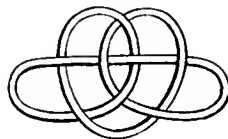

At a first glance it appears to be made of two once-linked trefoils, and therefore to have three degrees of beknottedness. But a little consideration shows that neither the trefoils nor the link have alternations of signs (*i.e.*, there is neither knotting nor linking), but that the whole is kept from resolution solely by the lap of cord which has been drawn as a straight line in the figure. This forms, as it were, the

tail of a Rupert's drop; break it, and the whole falls to pieces. A change of sign of either of the interior crossings on that lap *makes* one trefoil; of either of the 4 lateral external crossings, the 6-fold amphicheiral; of the upper crossing, the 4-fold amphicheiral; and of the lower axial crossing, the 5-fold of one degree of beknottedness. All these modes of resolution lead to the result that the knot is of 2-fold beknottedness.

12. It is now obvious why, in consequence of locking and not of amphicheirality as I first thought, the electro-magnetic test fails in certain classes of cases to indicate properly the amount of beknottedness. For it is clear that in pure locking there is no electro-magnetic work along the locked part of any one of the three courses involved. Hence, for the part of a knot or link which is locked, the electro-magnetic test necessarily gives an incorrect indication of beknottedness. Perhaps it may be said that, in such cases, beknottedness is not the proper name for this numerical feature of a knot:—but it is obviously correct *if defined as in § 7 above*.

13. A simple but thoroughly practical improvement on the methods given in my first paper for the graphical solution of Gauss' problem (extended) is as follows:—Draw the knot or link, as below, with a double line, like the edges of an untwisted tape, and dot (or go over with a coloured crayon) one of the two lines. Now it



is easy to see that, of the four angles at a crossing, one angle is bounded by full lines, and its vertical angle by dotted lines. These will be called the *symmetrical* angles. Also it is clear that the electro-magnetic work has one sign for the crossings when the symmetrical angles are right-handed, and the opposite sign when they are left-handed. Thus we can at once mark each crossing as *r* or *l*, silver or copper, at pleasure. If the figure be a knot, and if we cut it along a line dividing a symmetrical angle, re-uniting the pairs of ends on either side of that line, the whole remains a knot (still with alternations of over and under if the original was so), but of knottedness at least one degree lower. When the line divides an unsymmetrical angle, the whole becomes (after re-uniting the ends, as before) two separate closed curves, in general linked and, it may be, individually knotted. [When we treat a *link* in this way at any of the linkings (*i.e.*, where two *different* strings cross one another), it becomes a knot. It is curious that by this process a knot is equally likely to be changed into a knot or into a link, while a link *always* becomes a knot.] This method has the farther advantage of showing at a glance the various sets of crossings which we may choose for omission (in the electro-magnetic reckoning), as due merely to the *coiling* of the figure, not to knotting, linking, or locking. For each such crossing must belong to a simple loop, which, for reference, we will call

*fundamental.* Such a loop is detected immediately by its having (throughout) the full line or the dotted line for its external boundary, and therefore is necessarily closed at a symmetrical angle. If we now erase these fundamental loops in succession, till no crossings are left, the crossings at their bases form one of the groups which may be tried. When part of the knot has locking, it is sometimes necessary to try more than one of these groups before we arrive at the true measure of beknottedness. As this is a matter of importance, it may be well to discuss it a little farther.

14. When there is no beknottedness (whether true, or depending on linking or locking), the electro-magnetic work, with the proper correction for mere coiling, is certainly *nil*. But this *proper* correction requires to be found, and where there is locking its discovery sometimes presents a little difficulty. When there is no locking, all we need do is to draw the knot afresh, beginning at a point external to each of the fundamental loops, and making each crossing positive *when we first reach it*. It is evident that the fundamental loops or coils will now be simply laid on one another. The signs of *all* the crossings on any one loop may be changed, while that of the base of the loop is immaterial, and this process may be carried out with some or all of the other fundamental loops in any order. Compare the various signs in any state thus produced with those (alternate or not) of the original knot, so as to find the smallest number of changes necessary for its full resolution. The sign of the crossing at the base of each fundamental loop is simply to be disregarded. Another mode of going to work is to alter the signs at pairs of points where two fundamental loops cross, so as to diminish as far as possible the necessary number of real changes of sign. But we must be very careful in using this process, to see *that it does not introduce locking*.

15. When there is locking in part of the knot, the real difficulty is met with *only* if the crossing or crossings, which form as it were the key of the locked part, *must* also be taken as the base or bases of fundamental loops. In this case we commence the fresh drawing of the knot at a point exterior to the locking, but on the fundamental loop of which one of the key crossings forms the base. This ensures that the completion of the fundamental loop is effected by the *last* of the operations on the locked part. But the application of the method can be learned far more easily from an example or two than from any rules which could be laid down. Thus the following drawings represent the results of this method as applied to two of the knots already figured. In the first of these the two lower external crossings are taken

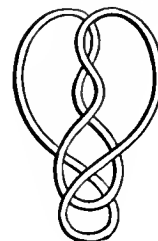
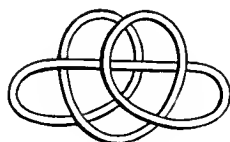



for the fundamental loops, and we see that the knot (if originally over and under alternately) requires for its full resolution only the change of sign of each of the two crossings which lie in its axis of symmetry. But, if we had chosen the crossings last mentioned as bases of fundamental loops, we should at once have felt the difficulty due to locking.

In the second, all four crossings in the axis of symmetry close fundamental loops; but the change of the sign of the *lowest* of these, alone (which is the key of the locked part), is required for the full resolution.

## APPENDIX.

*Note on a Problem in Partitions.*

(Read July 7, 1884.)

In the partition method of constructing knots of any order,  $n$ , of knottiness, we have to select from the group of partitions of  $2n$  those only in which no part is greater than  $n$ , and no part less than 2.

Thus, as given in the text, § 6, we have for sevenfold knottiness the series of partitions of 14;—but they are now arranged below in classes according to the value of the largest partition.

77	662	554	4442	33332	2222222
752	653	5522	4433	332222	
743	644	5432	44222		
7322	6422	5333	43322		
	6332	53222	422222		
	62222				

It is an interesting inquiry to find how many there are in each class, for any value of  $n$ . The number of classes is obviously  $n - 1$ ; and, if we remove from each the first partition (*i.e.*, that which is not inferior to any of the others), the remainders form a new set of classes of partitions which we may designate as

$$p_n^n, p_{n+1}^{n-1}, p_{n+2}^{n-2}, \dots, p_{2n-2}^2$$

respectively;—where  $p_r^s$  is defined as the number of partitions of  $s$ , in which no partition is greater than  $r$ , and none less than 2.

Without explicitly introducing finite differences or generating functions it is easy to calculate the values of the quantity  $p_r^s$ ;—and to put them in a table of double entry which can be developed to any desired extent by the simplest arithmetical processes. The method is similar to one which I employed some years ago for the solution of a problem in Arrangements (No. XXVII. above).

In the first place we see at once that if  $r > s$

$$p_r^s = p_s^s.$$

Thus, if  $r$  denote the column, and  $s$  the row, of the table in which  $p_r^s$  occurs, all numbers in the row following  $p_r^s$  are equal to it. Thus the values of  $p_r^s$  enable us to fill up half the table. In the remaining half  $r$  is less than  $s$ ; and by a dissection of this class of partitions, similar to that which was given above, we see that

$$p_r^s = p_{r-r}^s + p_{r-r+1}^{s-1} + \dots + p_{r-2}^2 + p_{r-1}^1 + p_r^0,$$

where the two last terms obviously vanish; and the first term is obviously 1 in the case of  $r = s$ , unless  $r < 2$ , when it vanishes.

Hence, if the following be a portion of the table, the crosses being placed for the various values of  $p_r^s$ , *nil* or not,

		Values of $r$ .								
		0	1	2	3	4	5	6	7	8
Values of $s$ .	0	+	+	+	+	+	+	+	H	+
	1	+	+	+	+	+	+	+	G	+
	2	+	+	+	+	+	+	+	F	+
	3	+	+	+	+	+	+	+	E	+
	4	+	+	+	+	+	+	+	D	+
	5	+	+	+	+	+	+	+	C	+
	6	+	B	+	+	+	+	+	+	+
	7	A	+	+	+	+	+	+	K	+

it will be seen at a glance that the above equation tells us to add the numbers A, B, C, D, E together, to find the number at K. This is quite general, so that L, in the second last column, is the sum of A, B, ..., H; and all the numbers beyond it, in the same row, are equal to it. In the table on next page, each number corresponding to the *first* L is printed in heavier type, and its repetitions are taken for granted.

Thus it is clear that simple addition will enable us to construct the table, row by row, provided we know the numbers in the first row and those in the first column. Those in the first and second columns are all obviously zero, as above. The rest of the first row consists of units. These are the values of  $p_r^0$ , i.e., the first term of the expression above for  $p_r^s$ . Hence we have the table on the following page, which is completed only to  $r = 17$ , with the corresponding sub-groups.

From the table we see that  $p_0^9 = 8$ . Hence the partitions of 18, subject to the conditions, are in number

$$8 + 11 + 11 + 14 + 10 + 8 + 3 + 1 = 66,$$

which agrees with the detailed list in § 7 above.

[The rule is to look out the number  $p_n^n$ , and add it to all those which lie in the diagonal line drawn from it *downwards* towards the left. But the construction of the table shows us that this is the same as to look out  $p_{2n}^n$  at once.]

Similarly we verify the other numbers of partitions given in the text.

And it is to be remembered that  $p_n^n$  is the number of required partitions in which  $n$  occurs, and that *every one* of the class  $p_{n+r}^{n+r}$  has for its largest constituent  $n - r$ . Thus, looking in the table for  $p_7^7$  and the numbers in the corresponding downward left-handed diagonal, we find the series

$$4 \quad 6 \quad 5 \quad 5 \quad 2 \quad 1,$$

which will be seen at once to represent the dissection of the partitions of 14 given above.

The investigation above was limited by the restriction, imposed by the theory of knots, that no partition should be less than 2. But it is obvious that the method of this note is applicable to partitions, whether unrestricted, or with other restrictions than that above. The only difficulty lies in the *bordering* of the table of double-entry. Thus, if we wish to include unit partitions, all we have to do is to put unit instead of zero at the place  $r = 1$ ,  $s = 0$ , and develop as before. Or, what will come to the same thing, sum all the columns of the above table downwards from the top, and write each partial sum instead of the last quantity added, putting unit at every place in the second column.

Similarly, we may easily form the corresponding tables when it is required that the partitions shall be all even, or all odd.

Table of the values of  $p_r^s$ ; the number of partitions of  $s$  in which no one is less than 2, nor greater than  $r$ .

(The values of  $r$  are in the first row, those of  $s$  in the first column.)

	0	1	2	3	4	5	6	7	8	9	10	11	12	13	14	15	16	17
0	0	0	1	.	.	.	.	.	.	.	.	.	.	.	.	.	.	.
1	0	0	.	.	.	.	.	.	.	.	.	.	.	.	.	.	.	.
2	0	0	1	.	.	.	.	.	.	.	.	.	.	.	.	.	.	.
3	0	0	0	1	.	.	.	.	.	.	.	.	.	.	.	.	.	.
4	0	0	1	1	2	.	.	.	.	.	.	.	.	.	.	.	.	.
5	0	0	0	1	1	2	.	.	.	.	.	.	.	.	.	.	.	.
6	0	0	1	2	3	3	4	.	.	.	.	.	.	.	.	.	.	.
7	0	0	0	1	2	3	3	4	.	.	.	.	.	.	.	.	.	.
8	0	0	1	2	4	5	6	6	7	.	.	.	.	.	.	.	.	.
9	0	0	0	2	3	5	6	7	7	8	.	.	.	.	.	.	.	.
10	0	0	1	2	5	7	9	10	11	11	12	.	.	.	.	.	.	.
11	0	0	0	2	4	7	9	11	12	13	13	14	.	.	.	.	.	.
12	0	0	1	3	7	10	14	16	18	19	20	20	21	.	.	.	.	.
13	0	0	0	2	5	10	13	17	19	21	22	23	23	24	.	.	.	.
14	0	0	1	3	8	13	19	23	27	29	31	32	33	33	34	.	.	.
15	0	0	0	3	7	14	20	26	30	34	36	38	39	40	40	41	.	.
16	0	0	1	3	10	17	26	33	40	44	48	50	52	53	54	54	55	.
17	0	0	0	3	8	18	27	37	44	51	55	59	61	63	64	65	65	66
18	0	0	1	4	12	22	36	47	58	66	73	77	81	83	85	86	87	.
19	0	0	0	3	10	23	36	52	64	75	83	90	94	98	100	102	.	.
20	0	0	1	4	14	28	47	64	82	95	107	115	122	126	130	.	.	.
21	0	0	0	4	12	29	49	72	91	110	123	135	143	150	.	.	.	.
22	0	0	1	4	16	34	60	86	113	134	154	168	180	.	.	.	.	.
23	0	0	0	4	14	36	63	96	126	155	177	197	.	.	.	.	.	.
24	0	0	1	5	19	42	78	115	155	189	220	.	.	.	.	.	.	.
25	0	0	0	4	16	44	80	127	171	215	.	.	.	.	.	.	.	.
26	0	0	1	5	21	50	97	149	207	.	.	.	.	.	.	.	.	.
27	0	0	0	5	19	53	102	166	.	.	.	.	.	.	.	.	.	.
28	0	0	1	5	24	60	120	.	.	.	.	.	.	.	.	.	.	.
29	0	0	0	5	21	63	.	.	.	.	.	.	.	.	.	.	.	.
30	0	0	1	6	27	.	.	.	.	.	.	.	.	.	.	.	.	.
31	0	0	0	5	.	.	.	.	.	.	.	.	.	.	.	.	.	.
32	0	0	1	.	.	.	.	.	.	.	.	.	.	.	.	.	.	.

From what has been stated in the previous pages, it is easy to see how to extend this table; forming the successive terms of each row by adding step by step upwards to the right along a diagonal, thence upwards to the top, zig-zag along the row of heavier type as soon as it is reached.

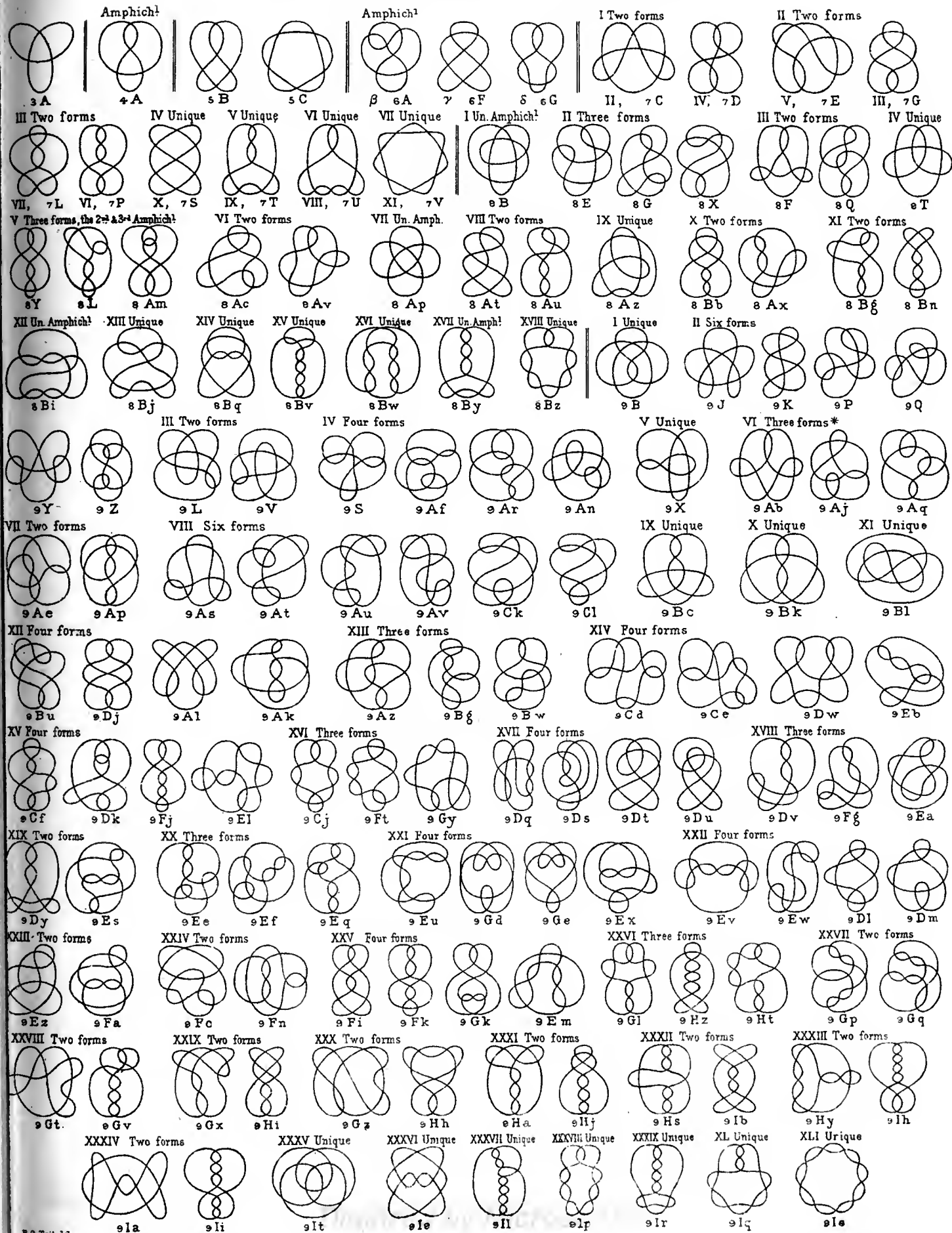

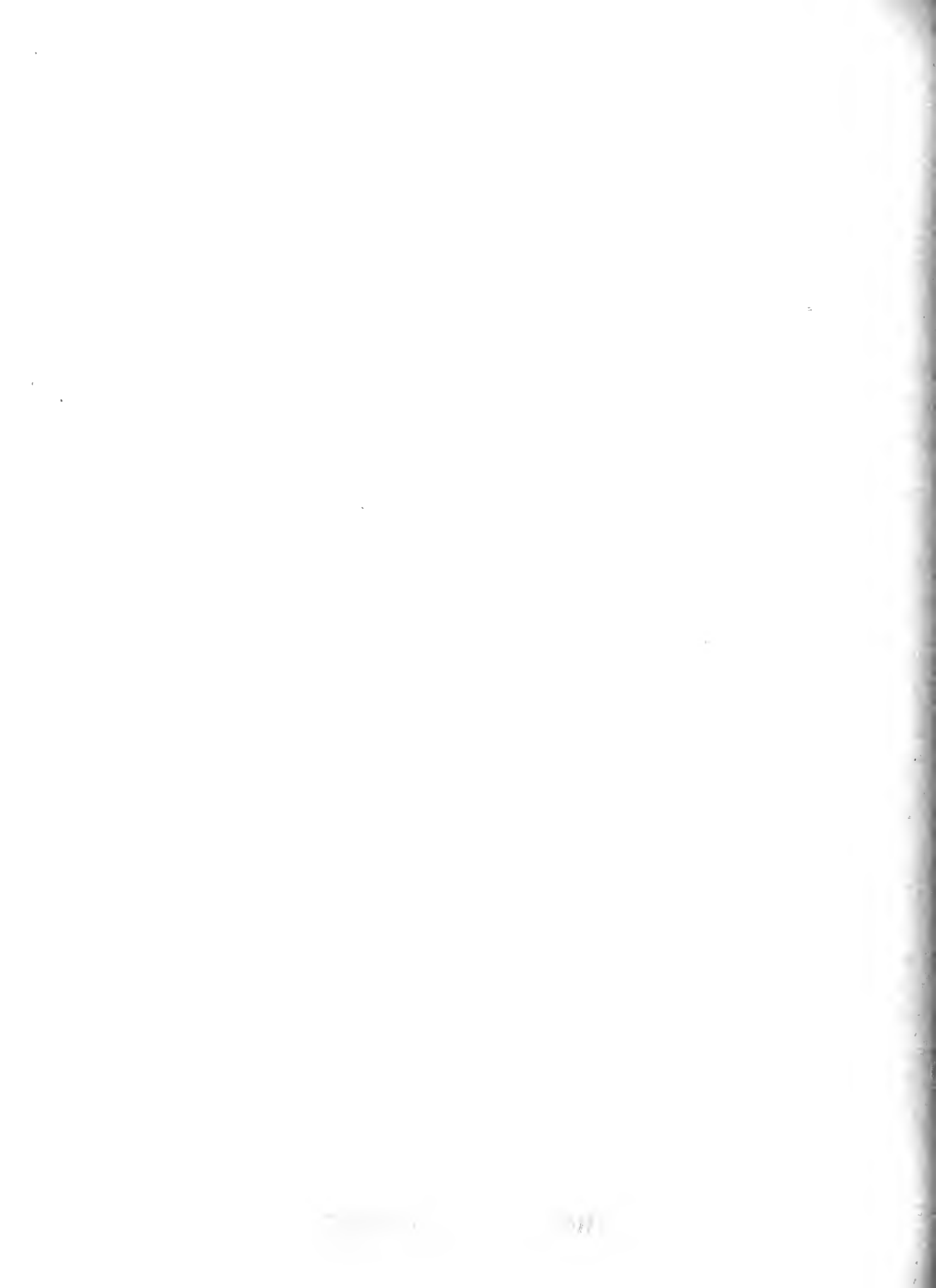

## XLI.

## ON KNOTS. PART III.

[*Transactions of the Royal Society of Edinburgh*, 1885.]

(Chapter I. read June 1st, Chapter II. July 20th, 1885. *One change, small but important, was made during printing. It is described at the end of the paper.*)

THE following additional remarks are the outcome of my study of the polyhedral data for tenfold knottiness, which I received from Mr Kirkman on the 26th of last January. My main object was, as in the first chapter of Part II., to determine the number of different types; as well as the number of essentially different forms which each type can assume, as distinguished from mere deformations due to the mode of projection.

This study has been a somewhat protracted one, in consequence (1) of the great number of tenfold knots; (2) of the very considerable number of distortions of several of the types, many of which are essentially distinct while others present themselves in pairs differing by mere *reversion*; and especially (3) of the fact that the polyhedral method often presents some of the distinct forms of one and the same type projected from essentially different points of view (of which, in the present case, there are sometimes twelve in all). Reason (3) depends on the fact that Kirkman's method occasionally builds up various forms of one type on different bases of a lower order, and it really involves additional labour only; but great care is requisite to avoid confusion as regards (2), and in consequence I may not have fully reduced the final number of distinct types. [At the end of this paper I shall give a simple illustration of the nature of this special difficulty.]

The fact that I was dealing with knottiness of an even order induced me to commence the testing of the materials at my command by picking out the Amphicheirals. This led to some new considerations of a very singular nature, which are

treated in the first of the following chapters. The second deals with the tenfolds as a whole.

### I. *Various Orders and Classes of Amphicheirals.*

1. As one form of check on Kirkman's results, I sought for an independent method of forming all the amphicheirals of a given order. But, as will be seen below, we must be careful in this matter, which is not so simple as I first thought. I therefore commence by recalling the original definition of an amphicheiral.

In § 17 of my first paper I introduced it thus:—

*An amphicheiral knot is one which can be deformed into its own perversion.*

The word "deformed" was here used in the sense of alteration of form by mere change of point of view, or mode of projection; a process which leaves the number of corners in each mesh, and the *relative* positions of the various meshes, unchanged. This definition implies that the right and left handed meshes are similar in pairs and similarly situated in *congruent* groups; and it will be adhered to for the present, though we shall afterwards find that there are at least three other senses in which a knot may be called amphicheiral, and shall thus be led to speak of different *orders* and *classes* of amphicheirals. The above definition will then be considered to belong to amphicheirals of the *First Order* and *First Class*.

2. Suppose an amphicheiral knot to be constructed in cord, and extended over the surface of a sphere which swells out when necessary so as to keep the cord tight like the netting on a gazogene. Let its various laps be displaced until the several corresponding pairs of right and left handed meshes are made equal as well as similar. Trace its position on the sphere. Now suppose it to become rigid, and move it about on the surface of the sphere. We can again bring it to coincide with its former trace, but in such a way that each left-handed compartment now stands where the corresponding right-handed one was, and each right-handed where its corresponding left-handed was. Now such a displacement, as we know, can always be effected by a finite rotation about a diameter of the sphere as axis.

This axis, of course, cannot terminate (at either end) inside a mesh, else that compartment could not be shifted by the rotation to the original position of the corresponding one of the other kind. Hence either end of the axis must be at a crossing, or midway on the lap of cord passing through two adjoining crossings. A little consideration shows that if one end be at a crossing the other also must be at a crossing, and the whole must be a link. This is easily seen from the fact that, if one end of the axis be at a crossing, the four meshes which meet there must each exactly fit that next it when the whole is turned through a right angle; and the series which immediately surrounds these must possess a similar property, &c., &c. Thus the whole spherical surface must be covered with a pattern which consists of four equal and similar parts,



each of which takes the place of the preceding one at every quarter of a rotation about the axis. And four laps of the string must therefore proceed all in the same way from one end of the axis to the other; since, if we can trace one lap of the string continuously from one crossing to the other, exactly the same must be true of the other three. [Of course, if the string cannot be traced from one crossing to the other, there must be two separate strings at least.]

Hence, for a true knot, both ends of the axis must be the middle points of laps; and therefore—

*There must be two laps, at least, in every amphicheiral knot, each of which is common to a pair of corresponding right and left handed meshes; and when the whole is symmetrically stretched over a sphere the middle points of these laps are at opposite ends of a diameter.*

3. With regard to the middle point of either of these laps, the various pairs of corresponding right and left handed meshes are situated at equal arcual distances measured in opposite directions on the same great circle. Hence if the whole be opened up at the middle point of either of these laps and projected on a plane symmetrically about the middle point of the other, the halves into which the plane figure is divided by any straight line passing through the latter point are congruent figures applied on opposite sides of that line as base; the point being, as it were, a *centre*. There are, thus, at least two ways of opening up any amphicheiral knot so as to exhibit this species of quasi-symmetry.

What precedes is on the supposition that the system of right, or of left, handed meshes can be applied to itself *in one way only*. If there be, as happens in some specially symmetrical cases, more than one way of doing this, there is a corresponding increase in the number of pairs of common laps, as defined in the preceding section.

It has also been assumed above that, on the sphere, the systems of right and left handed meshes are not only similar but *congruent*. The question of the possible existence of knots in which the system of right hand meshes shall be the *reversion* of the left hand system will be considered later.

4. We now obtain a perfectly general, though of course in one sense tentative, method of constructing amphicheirals of any order. Think of the result of § 3 as to the congruency of the halves of the knot when opened at either of the pair of corresponding laps. As a continuous line necessarily cuts the projection of a complete knot in an *even* number of points, the half figure which is to be drawn on one side of the common base must meet it in an *odd* number of points because one lap has been opened. Let these be called, in order, A, B, C, &c. Then, to form the half figure, these points must be joined in pairs, the odd one forming one end of the line whose other terminal is at the broken lap. These joining lines, and that with the free end, must be made to intersect one another in a number of points equal to *half* the knottiness of the amphicheirals sought. Every mode of doing this gives a figure which, when its congruent has been applied on the other side of the base, possesses the amphicheiral quasi-symmetry above described.

5. To ensure that the figure shall be a knot, and not a link or a set of detached figures, the following precautions are necessary. If  $A'$ ,  $B'$ ,  $C'$ , &c., in the congruent figure correspond to  $A$ ,  $B$ ,  $C$ , &c., in the original, they will be adjusted to one another as follows. (The case of five is taken as being sufficient to show the general principle.)

$$\begin{array}{ccccc} A & B & C & D & E \\ E' & D' & C' & B' & A' \end{array}$$

Now if  $B$  be joined with  $D$ , however the joining line be linked with the others,  $B$  will be joined to  $D'$ ; and these parts will form, together, one closed circuit, so that the figure is not a knot. Similarly if  $A$  and  $E$  be joined. Similarly if  $A$  be joined to  $B$ , and *also*  $D$  to  $E$ . If  $C$  be the terminal of the free lap, so will  $C'$ ; and again we have a figure consisting of more than one string.

It will be observed that the common characteristic of these excepted cases is that each possesses at least partial symmetry in the mode in which points to be joined are selected from the group. Hence the rule for selection is simply to *avoid every trace of symmetry*.

Even when this is done the final result may be a composite knot, *i.e.*, two or more separate knots on the same string. These can be detected and removed at once, so that it is not necessary to lay down rules for preventing their occurrence.

Repetitions of the same form from different points of view form the only really troublesome part of this process. These are inevitable, as we see at once from the fact that there may be several essentially different ways of cutting the complete quasi-symmetrical figure into congruent halves by lines meeting it in the *same* odd number of points. But it may also often be cut by one such line in one odd number of points and by another in a different odd number.

Still, with all these inherent drawbacks, the method is applicable without much labour to the tenfold amphicheirals; and it fully answered my purpose.

6. I had proceeded but a short way with the application of this method when I found that *there may be more than one distinct amphicheiral belonging to the same type*.

One example of this had been already given in § 48 of Part I. while I was dealing with amphicheirals, and again in Part II. in my census of eightfolds (Type V.), but I had carelessly passed it over as a special peculiarity probably due to the fact that the knot in question, though not composite, was constructed of portions each of which possessed, all but complete, the outline of the fourfold amphicheiral. From the point of view taken in § 4 above, however, the reason of the property is evident. For if the half knot, when the extremities of the strings are all held fixed, be capable of a distortion which shall change the relative positions of some of its meshes or the numbers of their corners, the same can of course be done with the congruent half. The whole preserves its type, and is still amphicheiral, but it becomes an essentially distinct form.

It will be seen that there is one type of tenfolds which has four different amphicheiral forms; another contains three; while there are four types each with two forms. The remaining seven amphicheiral types are either unique forms or have no amphicheiral distortion.

7. We are now prepared for one extension of the definition of an amphicheiral given in § 1 above. But we prefer to establish a new and independent definition:—thus

*An amphicheiral knot of the First Order and Second Class is one which can be distorted into its own perversion.*

Under this definition every distortion of an amphicheiral knot is included, even although it be such that its right and left handed meshes do not correspond to one another in pairs. For, whatever be the distortion, and whatever parts of the knot be affected by it, an exactly similar distortion might have been applied to the congruent parts of the original amphicheiral. These two distorted forms are, of course, capable of being distorted one into the other:—and that other is its perversion.

Every amphicheiral knot of the first order and second class corresponds to, and can be distorted into, at least one of the first class:—but the converse is not necessarily true.

8. Whether there are other classes of amphicheirals of the first order besides these I do not yet know. I have made attempts to construct a specimen of a supposed Third Class which should have the property of being changed into its own perversion by the twisting of a *single*, limited, portion, while the result could *not* be obtained by any simpler method. Such forms, if they exist, must in general be incapable of distortion into amphicheirals of either the first or the second class. This search has been fruitless. Among the requirements which it introduces, is the necessity for an ordinary amphicheiral in which *two* pairs of corresponding right and left hand meshes shall have one common corner; a condition which does not seem to be satisfied except by the simplest (amphicheiral) link, in which indeed it *must* be satisfied, as there are but four compartments in all. But this gives no satisfactory solution.

9. We may now take up the curious question raised in the last paragraph of § 3 above.

A simple method of producing arrangements in which the group of left handed meshes is similar to, but not congruent with, that of the right handed follows at once from the fact that, if one end of a diameter of a sphere trace a figure of any kind, the other end traces a similar and equal but (except in special cases of symmetry) non-congruent figure. These figures can, if we choose, be taken so as together to form one closed curve; and this, *along with a great circle of the sphere*, forms a link of two cords possessing the required property. On the plane we can carry out this construction by describing any figure within a circle, along with its inverse as regards the circle but on the opposite side of the centre; and arranging

so that these may join into a continuous curve linked with the circle. But this arrangement *remains a link* when we unite the new curve with the circle by so introducing new meshes as to leave the whole possessed of the required property.

Or, we may trace any curve on a hemisphere, and its image (in the common base) on the other hemisphere. These, together with the great circle separating the hemispheres, give another link solution.

It is clear, from the essentially limited nature of the spherical surface, that these two methods give the only possible solutions of the problem:—*i.e.*, when the corresponding right and left handed meshes required by the conditions are made equal in pairs, the lines joining similarly situated points in them must either meet in one point (which, of course, must be the centre of the sphere), or they must be parallel.

10. As I did not at once see how to obtain solutions corresponding to *unifilar* knots by means of either of these methods, I asked Mr Kirkman whether he knew of a polyhedron which possessed the requisite property. The first he suggested to me corresponded, as I easily found, to a trifilar which belongs to the results of the first method above:—*i.e.*, one of its cords being taken as the circle, the other two were inverses of one another with regard to it. But, as soon as he mentioned to me that the polyhedron, corresponding to a composite knot consisting of two separate once-beknotted 5-folds on the same string, satisfies the special conditions of the present question (though inadmissible on other grounds), I saw why I had failed in obtaining unifilars by the first of the two methods above. For the purpose of avoiding trifilars from the first I had always made the curve traced by either end of the moving diameter (in the process of § 9 above) *cross* the great circle wherever it met it, so as to join that traced by the other end. No insertions of new meshes could then reduce the whole to a unifilar without depriving it of the property for which it was sought.

11. But if we make the closed curve traced by one end of the moving diameter *touch* the great circle in one point, the point of contact must of course be regarded as a *crossing*, while the circle and the closed curve necessarily fuse into one continuous line. The same happens with the curve traced by the opposite end of the diameter. Thus we may obtain with the greatest ease any number of unifilars satisfying the conditions. And it is clear that, by a slight extension of the definition above, all such knots will be brought under the general term *amphicheiral*. To make them true knots, *i.e.*, not composites, the curves traced by the ends of the diameter must intersect one another, which implies that they must each cut the great circle in two points at least besides touching it at one or more. Hence the lowest knottiness in which they can possibly occur is 10-fold; *i.e.*, 2 points of contact with the great circle, 4 intersections with it, and 4 intersections of the two branches.

This process fails when applied in connection with the second method of § 9, for it brings in triple points which cannot be opened up into three double ones without depriving the whole figure of the desired property.

12. The 10-fold, whose genesis is described in last section, has the form shown in Plate VII. fig. D, where the great circle is made prominent. It is easily recognised as the ordinary amphicheiral, fig. 31, of Plate VIII. The reason why it figures in both categories is that the arrangement of the right or left handed meshes, being symmetrical, is not changed by reversion. Thus every ordinary amphicheiral, which is in this sense symmetrical, belongs also to the new kind of amphicheirals with which we are now dealing.

Plate VII. fig. A shows a 12-fold knot, which is its own inverse with regard to the part drawn as nearly circular, and which is not amphicheiral in the ordinary sense.

Equal distortions of two corresponding parts give it the new form fig. B, which is also its own inverse with regard to the circular part.

But if, as in fig. C, we perform one of these distortions alone, the form is no longer its own inverse. But it is certainly amphicheiral, in the sense that it can be distorted into its own perversion. This is effected, of course, by undoing the single distortion which produced C from A, and inflicting the other of the pair of distortions which, together, produced B from A.

13. Thus there are at least four different senses in which a knot may be amphicheiral.

A ( $\alpha$ ) Those in which the systems of right and left hand meshes are similar and congruent.

A ( $\beta$ ) Unsymmetrical distortions of any of the preceding, when such exist. [When the distortion is symmetrical the knot remains one of A ( $\alpha$ ).]

B ( $\alpha$ ) Those in which the systems of right and left hand meshes are similar but not congruent.

B ( $\beta$ ) Unsymmetrical distortions of any of the preceding. [When the distortion is symmetrical the knot remains one of B ( $\alpha$ ).]

A and B may be spoken of as different *Orders*, the *First* and *Second*;  $\alpha$  and  $\beta$  as *Classes*, *First* and *Second*. As already stated, the knot of fig. D belongs to both orders. But no knot can belong either to both classes of one order, or to the first of one order and the second of the other.

14. In fig. (D) the 10-fold (fig. 31) of § 11 is drawn so as to exhibit its symmetry. And we thus see at a glance that there are at least two ways (indicated by *heavier* lines, one continuous, the other dotted) in which we can choose the laps which are to form the circle with regard to which it is its own inverse.

Fig. 38 of the 10-folds, which by reason of its symmetry belongs to both orders of amphicheirals, can have its circles shown as in figs. (E) and (F).

15. But if we take a non-symmetrical knot of the kind B ( $\alpha$ ), such as fig. A above treated, we obtain some still more striking results as to the number of ways

in which we can choose the laps which form the circular portion. In this figure corresponding right and left handed meshes are marked with the same letter.

Thus, if we throw out the right hand mesh,  $d$ , from the contents of the circle and take in the left hand  $d$  instead, the figure (drawn to show the new circle) becomes fig. G.

If we throw out  $f$ , and take the amplexum instead, we obtain fig. H.

But, if we throw out from the circle  $g$ ,  $c$ , and  $e$ , and take instead of them the corresponding external meshes, the figure takes the curious form K. Here the full line is the new boundary between the two halves of the figure. This new boundary, as well as the entire figure, is easily seen to be its own inverse with regard to the part bounded by the heavier portion of the full line. This, however, is only one of four ways in which it might be selected from the full line alone. Such modifications are very curious as well as numerous, but we cannot pursue them here.

16. In the upper rows of Plate VII. I have given the amphicheirals of the first class, up to the tenfolds inclusive. They are drawn on the principle of § 4 above, and the first form in which each presented itself has been preserved. A comparison of these, with the corresponding figures as drawn in Plate VIII. directly from Kirkman's results, is very instructive.

[*Added*, Oct. 19, 1885.—Though the general statement in § 11 above is true from the point of view there taken, there is a possibility of evading it. Thus, if we draw a figure like E, Plate VII., but with a four-pointed star inside, we get vii. of the 8-folds; which is thus shown to be an amphicheiral of the Second, as well as of the First, Order. But, if we try a three-pointed star, we get the simplest trifilar locking; as in Part I. § 42 (1), and Part II. § 8.]

## II. *Census of Ten-fold Knottiness.*

17. Omitting composites, the number of separate types of 10-fold knottiness is, as shown in Plates VIII., IX., 123. Of these 48 are unique, while the remaining 74 give 315 distinct forms, 364 individuals in all. The largest number of distinct forms for one type is 12; and there are two such groups. One type which furnishes a group of 10, has 4 of them amphicheirals of the first order and first class, the remainder of the second class.

Each of the figures is drawn in the special deformation in which it is presented by the polyhedral method; and, for reference, the corresponding designation of the knot in Kirkman's list is appended to it.

18. Of the 107 partitions of 20, under the limits imposed by the nature of a knot, 52 only are utilised; the rest belonging to links, composites, &c. These are as below; each being followed by a distinctive letter, which will presently be employed (for brevity) in place of it.

For knots with 6 right handed and 6 left handed meshes:—

653222 A	544322 F
643322 B	543332 G
633332 C	533333 H
554222 D	444332 K
553322 E	443333 L

For 5 meshes of one class and 7 of the other:—

77222 <i>a</i>	65432 <i>l</i>	5522222 $\alpha$
76322 <i>b</i>	65333 <i>m</i>	5432222 $\beta$
75422 <i>c</i>	64442 <i>n</i>	5333222 $\gamma$
75332 <i>d</i>	64433 <i>p</i>	4442222 $\delta$
74432 <i>e</i>	55532 <i>q</i>	4433222 $\epsilon$
74333 <i>f</i>	55442 <i>r</i>	4333322 $\zeta$
66422 <i>g</i>	55433 <i>s</i>	3333332 $\eta$
66332 <i>h</i>	54443 <i>t</i>	
65522 <i>k</i>	44444 <i>u</i>	

For 4 of one and 8 of the other:—

8732 <i>a</i>	7652 <i>f</i>	43322222 $\theta$
8633 <i>b</i>	7643 <i>g</i>	33332222 $\kappa$
8552 <i>c</i>	7544 <i>h</i>	
8543 <i>d</i>	6653 <i>k</i>	
7742 <i>e</i>	6554 <i>l</i>	

And for 3 of one and 9 of the other:—

992 <i>p</i>	965 <i>s</i>	33222222 $\lambda$
983 <i>q</i>	875 <i>t</i>	
974 <i>r</i>	776 <i>u</i>	

19. In Part II. of this series I arranged the types of each degree of knottiness in the order in which their respective deformations first appeared in Mr Kirkman's lists. This had the disadvantage of mixing up together types with very different relative numbers of right and left handed meshes. On the present occasion I have taken in the first rank the knots which have an equal number of meshes (six) of each kind, next those which have respectively 5 and 7, 4 and 8, &c. This will considerably simplify the process of seeking for any particular ten-fold in so long a

list. The arrangement of the various types in each rank, however, follows somewhat closely the order of their earliest appearance in the first list which I got from Mr Kirkman, that upon which I commenced the present work.

To identify any 10-fold, all that is necessary is to count the numbers of corners in the respective right and left handed meshes, look out the contracted expressions for the corresponding partitions of 20 in § 18, and then search below for the symbol, or pair of letters so obtained. Their *order*, of course, is immaterial, as it can be altered by a mere change of mode of projection. If the symbol occur more than once, a closer examination must be made, account being now taken of the way in which the right, *or* the left handed, meshes are coupled together. This is easily done as in § 20 of my first paper.

20. The number of distinct forms which I detected as not contained in Mr Kirkman's first list of 10-folds bears a far smaller ratio to the whole than was the case with the nine-folds. I consider that this is due not to my remissness, but to Mr Kirkman's improvements in his methods, *i.e.*, rather to the non-existence than to the non-detection of omissions; and I think it is improbable that any distinct variety of a recognised type has escaped detection. Thus in the present census some types may be omitted (this is more likely to be true of unique types than of others); and I may have, as already indicated, grouped in two or more smaller detachments the varieties of one and the same type. But the possibility of either defect is due to the somewhat tentative nature of the methods employed.

The guarded way in which I spoke (Part II., § 1) of the completeness of the *Census* has been justified by a recent observation made by Mr Kirkman, *viz.*, a 9-fold not included either in his list or in mine. Fortunately this knot, figured as fig. L., Pl. VII., is not a new type but a distinct form of type VI. of the 9-folds as shown in the Plate attached to Part II. My methods ought to have supplied this additional member of a group, of which some forms had been furnished by Kirkman; but I had not, at the time, much readiness in applying them. The labour of the 10-folds has made me much more skilful than before in this matter.

21. In the following list, the order is the same as in the plates. The symbols for each knot are so written that the second, in all cases, corresponds to the group of meshes to which (as the figure happens to be drawn) the amplex belongs.

*The various Types of Ten-folds with their distinct Forms.*

Six right and six left hand meshes; 24 non-unique types, 14 unique; 133 individual distinct forms in all. Amphicheirals of the first order and first class are marked by a bar over the symbol instead of a repetition.



1.  $\bar{C}$ ,  $\bar{G}$ , GC, GG, CG, KC, KG,  $\bar{G}$ , GK,  $\bar{K}$ .    2. FC, GF, GF, GF.
3. HB, LB, BC, GB, BG, KB, HF, FC, FG, LF, GF, FK.
4. GE, KE, GE, GE, BK, GB, GB, KB, BG, GB, EK, EG.
5. FF, KB, FB, BF, FF, FK.    6. GE, LE, KE.
7. FE, FG, FB, EB, EG, EE, FE, FG, FB.    8. FK, KF.    9.  $\bar{F}$ , FF,  $\bar{F}$ .    10. GF, KF.
11. BF, KE, BB, GF, KG, GB, EF, KB, BE.    12. LF, LF, FH.    13. KG,  $\bar{K}$ ,  $\bar{G}$ .
14.  $\bar{B}$ ,  $\bar{E}$ ,  $\bar{G}$ , EB, BG, EG.    15.  $\bar{A}$ , EA,  $\bar{E}$ .    16. BB, FB, KB, KF, FB, FF.
17. GF, GF.    18. FD, DB, KD.    19. FA, KA, FA, GA, GA, EA.
20. BA, KA, KA, AF.    21. GA, GA, AF, BA.    22. FB,  $\bar{B}$ ,  $\bar{F}$ .    23. DB, FD.
24. EA, AA.    25. KG.    26.  $\bar{G}$ .    27.  $\bar{F}$ .    28. LK.    29.  $\bar{K}$ .    30. LG.
31.  $\bar{F}$ .    32. EF.    33. FE.    34. EF.    35.  $\bar{D}$ .    36. AD.    37.  $\bar{A}$ .    38.  $\bar{H}$ .

Five meshes of one kind, seven of the other. Forty-three non-unique types, twenty-one unique—200 distinct forms in all.

39. *es, es, ep,  $\gamma p$ ,  $s\gamma$ ,  $s\gamma$ .*    40. *em, em, ef.*    41. *el, ee,  $\gamma l$ ,  $\gamma e$ ,  $\eta e$ ,  $\eta l$ ,  $\zeta l$ ,  $\zeta e$ ,  $e\zeta$ ,  $l\zeta$ .*
42.  *$\zeta q$ ,  $\gamma l$ ,  $e l$ ,  $\gamma q$ ,  $e q$ ,  $\zeta l$ .*    43. *ef, em, ep, es,  $\gamma f$ ,  $\gamma m$ ,  $\gamma s$ ,  $\gamma p$ ,  $p\zeta$ ,  $s\zeta$ ,  $\zeta m$ ,  $\zeta f$ .*    44. *se, te.*
45.  *$\zeta d$ ,  $\zeta h$ ,  $eh$ ,  $eh$ ,  $ed$ ,  $ed$ ,  $h\zeta$ ,  $d\zeta$ .*    46.  *$\zeta l$ ,  $\zeta l$ ,  $\eta l$ .*    47.  *$k\gamma$ ,  $ek$ ,  $\eta k$ ,  $\zeta k$ .*
48. *eh, ed, em,  $h\beta$ ,  $m\beta$ ,  $d\beta$ .*    49.  *$\zeta c$ ,  $\zeta c$ ,  $\eta c$ ,  $\gamma c$ ,  $\zeta c$ ,  $ec$ .*    50.  *$g\gamma$ ,  $eg$ ,  $\zeta g$ ,  $\zeta g$ .*
51.  *$\zeta b$ ,  $\zeta b$ ,  $\zeta b$ ,  $b\epsilon$ ,  $\gamma b$ .*    52.  *$\beta b$ ,  $eb$ ,  $h\beta$ ,  $eh$ ,  $eh$ ,  $eb$ .*    53.  *$er$ ,  $\beta r$ ,  $el$ ,  $el$ ,  $\beta l$ ,  $l\beta$ .*    54.  *$p\epsilon$ ,  $t\epsilon$ .*
55.  *$s\beta$ ,  $t\beta$ ,  $m\beta$ ,  $s\beta$ ,  $p\beta$ ,  $s\beta$ .*    56.  *$\delta f$ ,  $\delta p$ ,  $\delta s$ .*    57.  *$u\gamma$ ,  $\gamma n$ ,  $en$ ,  $en$ .*
58.  *$\zeta r$ ,  $r\gamma$ ,  $ee$ ,  $\gamma e$ ,  $\zeta e$ ,  $er$ .*    59.  *$\delta l$ ,  $\delta q$ .*    60.  *$ee$ ,  $e\gamma$ ,  $l\gamma$ ,  $el$ ,  $\zeta l$ ,  $\zeta e$ .*
61.  *$ee$ ,  $el$ ,  $et$ ,  $t\beta$ ,  $e\beta$ ,  $l\beta$ .*    62.  *$e\beta$ ,  $p\beta$ ,  $l\beta$ ,  $el$ ,  $ep$ ,  $ee$ .*    63.  *$ek$ ,  $k\gamma$ ,  $\zeta k$ .*    64.  *$\beta l$ ,  $\beta q$ ,  $s\beta$ .*
65.  *$r\beta$ ,  $ec$ ,  $er$ ,  $\beta c$ .*    66.  *$eb$ ,  $\beta b$ ,  $eb$ .*    67.  *$d\beta$ ,  $m\beta$ ,  $\beta l$ .*    68.  *$d\beta$ ,  $\beta l$ ,  $s\beta$ .*
69.  *$eg$ ,  $g\gamma$ .*    70.  *$\delta d$ ,  $l\delta$ .*    71.  *$\beta r$ ,  $t\beta$ ,  $e\beta$ .*    72.  *$l\beta$ ,  $r\beta$ .*    73.  *$p\alpha$ ,  $t\alpha$ ,  $l\alpha$ ,  $r\alpha$ .*
74.  *$ec$ ,  $r\beta$ ,  $r\epsilon$ ,  $c\beta$ .*    75.  *$ek$ ,  $\beta k$ .*    76.  *$\beta c$ ,  $ec$ .*    77.  *$ea$ ,  $ea$ ,  $a\beta$ .*    78.  *$b\beta$ ,  $h\beta$ .*
79.  *$\beta c$ ,  $ec$ .*    80.  *$r\alpha$ ,  $a\epsilon$ .*    81.  *$h\alpha$ ,  $ab$ .*    82.  *$\zeta u$ .*    83.  *$se$ .*    84.  *$et$ .*    85.  *$\zeta t$ .*
86.  *$\zeta r$ .*    87.  *$\eta s$ .*    88.  *$p\zeta$ .*    89.  *$er$ .*    90.  *$\zeta n$ .*    91.  *$eq$ .*    92.  *$r\epsilon$ .*    93.  *$\zeta s$ .*
94.  *$m\zeta$ .*    95.  *$r\epsilon$ .*    96.  *$el$ .*    97.  *$l\epsilon$ .*    98.  *$el$ .*    99.  *$eh$ .*    100.  *$\beta k$ .*    101.  *$b\beta$ .*    102.  *$aa$ .*

Four meshes of one kind, eight of the other. Seven non-unique types and eight unique—twenty-five distinct forms in all.

103.  *$\kappa f$ ,  $\theta f$ .*    104.  *$\kappa a$ ,  $\kappa a$ ,  $\theta a$ .*    105.  *$\kappa d$ ,  $\kappa g$ ,  $d\theta$ ,  $g\theta$ .*    106.  *$\kappa c$ ,  $\theta c$ .*    107.  *$\theta d$ ,  $l\theta$ .*
108.  *$\theta b$ ,  $g\theta$ .*    109.  *$\theta l$ ,  $\theta h$ .*    110.  *$\kappa k$ .*    111.  *$l\kappa$ .*    112.  *$\kappa h$ .*    113.  *$\kappa g$ .*
114.  *$\theta k$ .*    115.  *$\theta f$ .*    116.  *$\theta e$ .*    117.  *$a\theta$ .*

Three meshes of one kind, nine of the other. Six unique types.

118.  *$\lambda u$ .*    119.  *$\lambda q$ .*    120.  *$\lambda p$ .*    121.  *$\lambda s$ .*    122.  *$\lambda r$ .*    123.  *$\lambda t$ .*

22. The nature of the special difficulty hinted at in the beginning of the paper will be easily seen from the simple case illustrated by the four figures M, Plate VII. They denote various forms of the type 40 of Plate VIII.

It will be noticed that the crossings A, B, C may, one, two, or all, be changed from one lap of the string to the other, as shown in the second figure. Also D may be transferred to a position between A and B, or between A and C. There are thus two positions for each of A, B, and C; and three positions for D; giving 24 combinations in all. But it is clear that we need not shift D at all, so far as the outline of the figure is concerned; for a mere rotation of the whole in its own plane (as A, B, and C are similar to one another) will effect this. Then a change of B will merely give the *reverse* of the figure obtained by changing C. Again, by inverting the first figure about a point in the inner mesh, we get the second. If we had changed C, and then inverted, we should have got the same figure as by changing simultaneously A and B. By changing C alone in the first, we get the third; but by shifting D in the first we get the fourth; and these two are obviously each the reverse of the other. Thus the 24 figures reduce to the three shown in Plate VIII. As another example, take the third form of the third type of 10-folds as given in Plate VIII. Two of the crossings on its external boundary can be shifted, but each to one other place only. The form itself, and the same with one or both of these crossings shifted, give a set of four; each of which can take five new forms by the shifting of other crossings. But it will be found that the 24 forms thus obtained are identical in pairs;—thus reducing to the 12 given in the Plate.

23. Mr Kirkman informs me that he has nearly completed the enumeration and description of the polyhedra corresponding to the unifilar 11-folds. I hope, therefore, at some future time to lay before the Society the census of 11-fold knottiness. This was the limit to which I ventured to aspire nearly two years ago, in a paper\* which, I am happy to think, directed Mr Kirkman's attention to the subject.

24. It must be remembered that, so far as these instalments of the census have gone, we have proceeded on the supposition that in each form the crossings have been taken *over and under alternately*. But, as was shown in § 13 of Part I., as soon as we come to 8-folds we have some knots which may preserve their knottiness even when this condition is not fulfilled. These ought, therefore, to be regarded as proper knots and to be included in the census as new and distinct types. This is a difficulty of a very formidable order. It depends upon the property which I have called *Knotfulness* (Part I. § 35; II. § 6), for whose treatment I have not yet managed to devise any but tentative methods.

To show, by a single case (even though not thoroughly worked out), of how great importance is this consideration, I have appended to Plate VII. the five figures N; with the nature of each crossing indicated. The numbers affixed show the positions they occupied in the census of 8-folds, when the crossings were alternately over and under. *Then* they were all unique knots, incapable of any change of form.

\* "Listing's Topologie," § 22, *Phil. Mag.*, Jan. 1884. [To be reprinted below. 1898.]

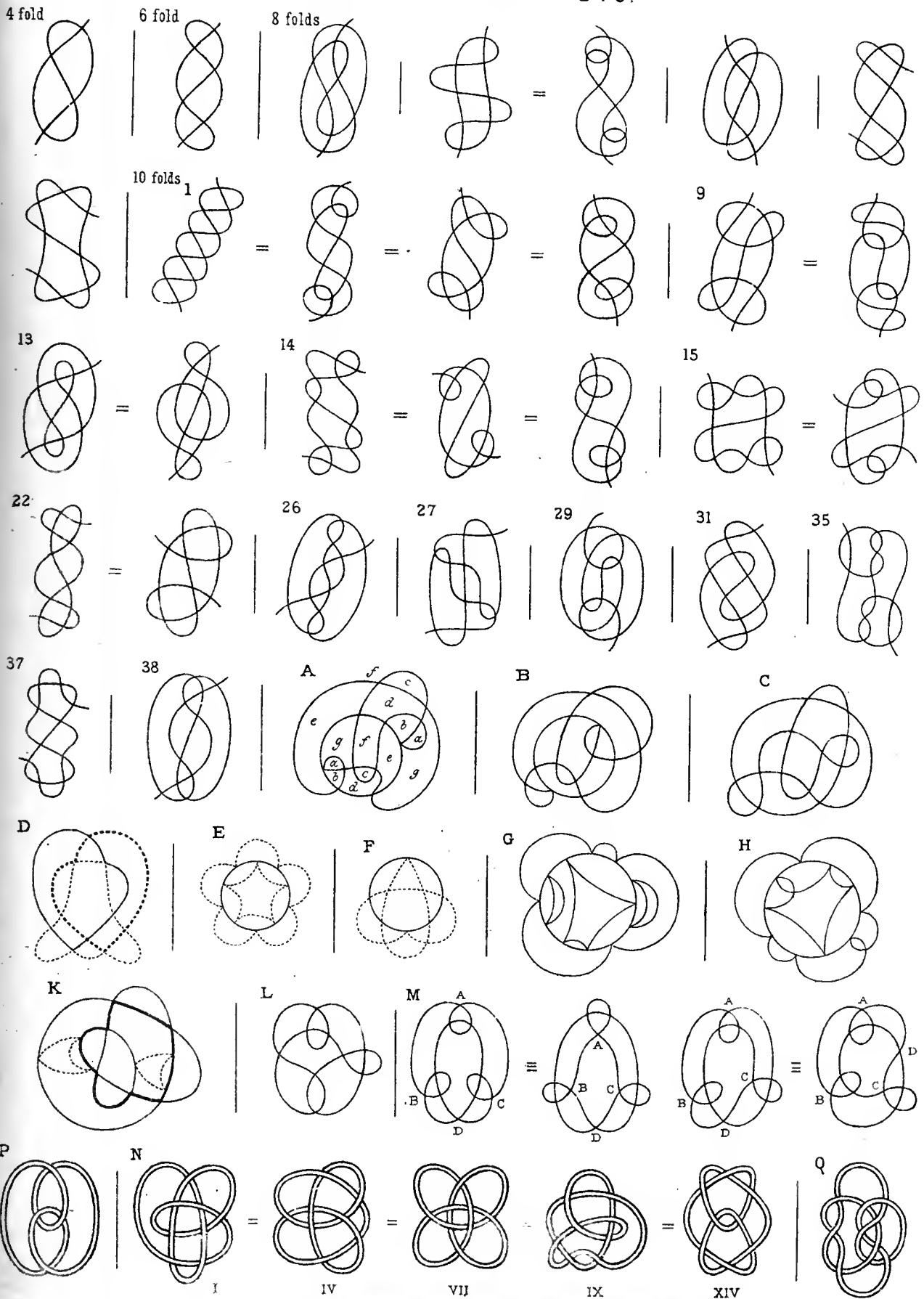



TENFOLD KNOTTINESS.

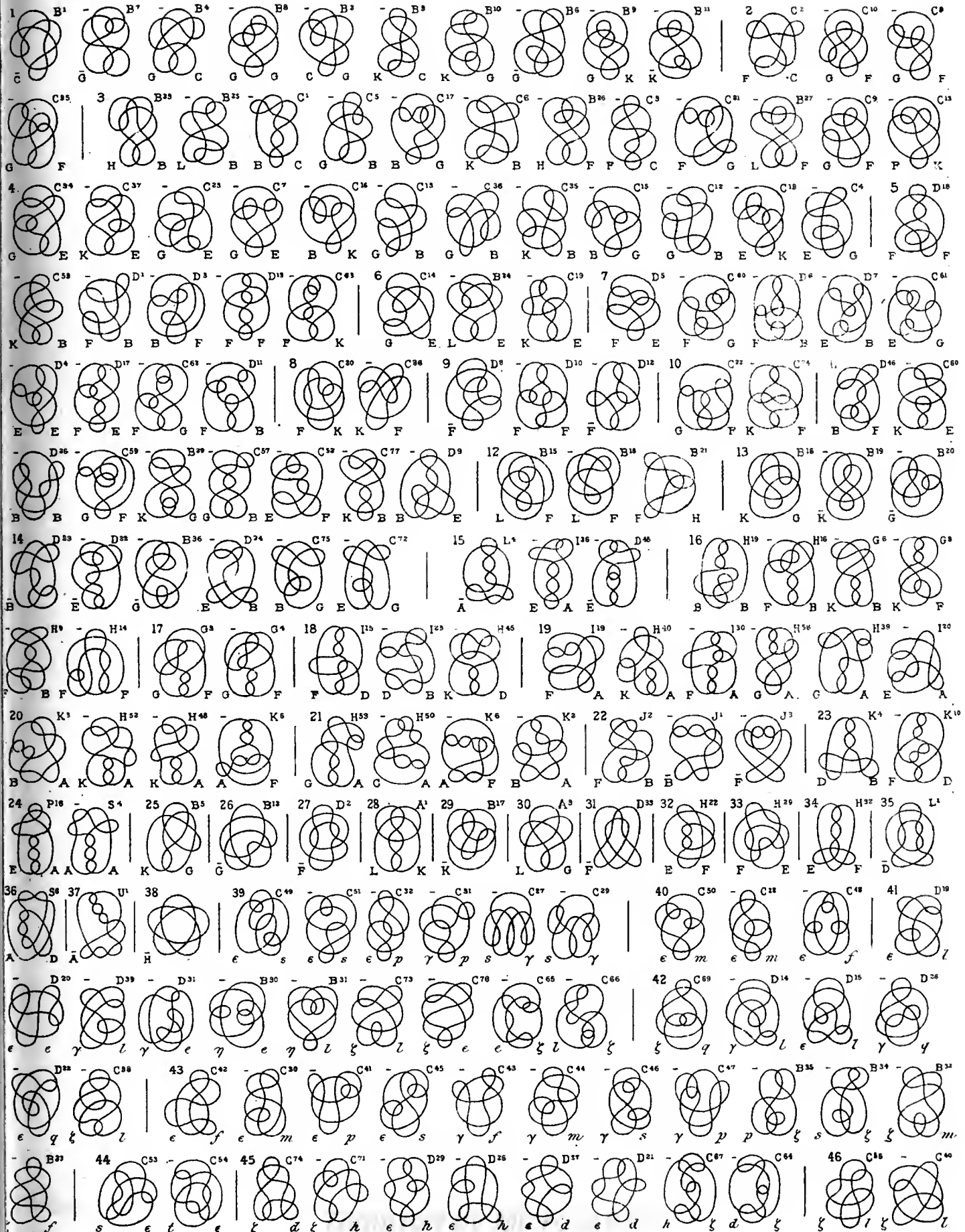



TENFOLD KNOTTINESS.

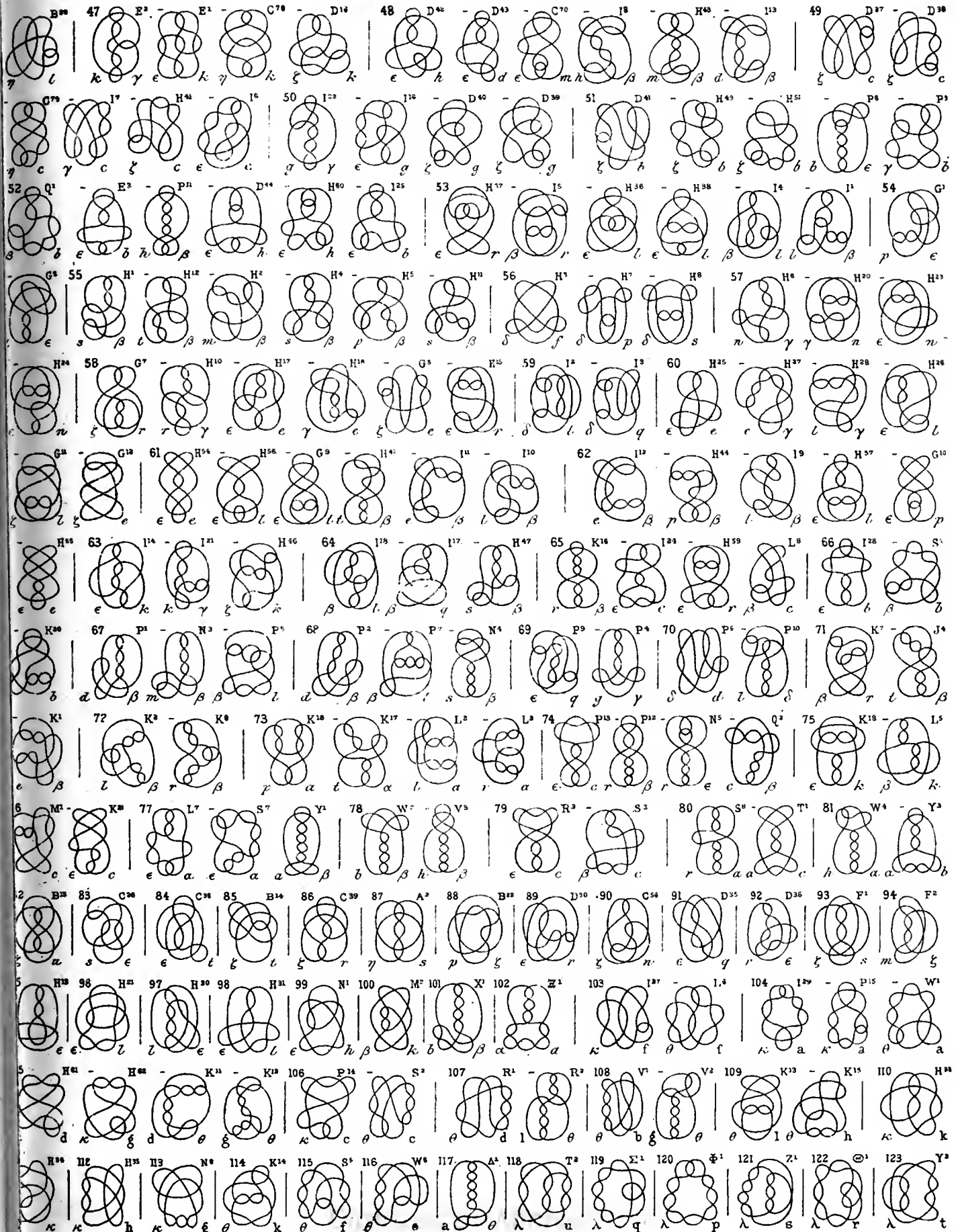





Now they are capable of being changed into one another. The linked trefoils in N, xiv. are perversions of one another. But we may have them of the same kind, and the link such that there shall be continuations of sign. This was briefly treated in Part I. § 42, 1. How many new types may by this process be added to the census, I have not yet made out with certainty even for the 8-folds.

*P.S.*—I may introduce here, as a note on Part I. of this series of papers, a remark or two with reference to the three-ply plaits treated there; in § 27 as fully knotted, and in § 42, 1, as fully beknotted. First, it is obvious that the 4-fold, as first drawn in § 17, should have been repeated in Plate V., at the head of the series of figures 15, 16, 17, &c. It is the case of  $3n+1$  of § 27, with  $n=1$ . Secondly, with its crossings arranged as in fig. P, Plate VII. of the present paper, it should have come in before figs. 24 and 25 of Plate VI., Part I., in a form reducible to the ordinary trefoil. Fig. 25 of that Plate puzzled me much at the time when I drew it, for I could not account for the production of a 3-fold and a 5-fold (linked) from a figure possessing a peculiar kind of (cyclonic?) symmetry round an axis. The figure is *accurate*, but I now see that it gives an erroneous impression of the true nature of the knotfulness. The correct idea is at once obtained from Plate VII., fig. Q, of the present paper. The knot is an irreducible trefoil, with a second of the same character tied *twice* through one of its three-cornered meshes.

(*Added, September 3, 1885.*)

Three days ago I received from Mr Lockyer a copy of a most interesting pamphlet "On Knots, with a Census for Order Ten," a reprint from the *Trans. Connecticut Acad.*, vol. VII., 1885. The author, Prof. Little of the State University, Nebraska, has made an independent census of 10-fold knots; employing the partition method, with some new special rules analogous to those in Mr Kirkman's recent paper. So far as I can judge from a first hasty comparison of the mere number of types and forms in each class, there are important discrepancies between this census and my own. One of these, at least, is due to a slip on my part; and, as my paper was not printed off when I detected it, I have taken the opportunity of correcting it both in the text and in the corresponding Plate. I had failed to notice that the two forms which now appear under No. 109 really belong to one type. Hence I have had to reduce by one the number of the distinct 10-fold types which was originally given in my paper. I hope in time to make a full comparison of the two versions of the census. Meanwhile I may note that there is one omission, and also one duplicate, in Class VI. of Mr Little's version. This duplicate has led him to insert one type too many.

More than a month ago I received from Mr Kirkman the full polyhedral data for the census of 11-folds, which I hope soon to undertake. The number of forms is so great, and the time I can spare for the work so limited, that I cannot promise it at an early date. [This arduous work was kindly undertaken by Prof. Little, who, in 1890, gave the 357 types in Plates I., II., *Trans. R.S.E.*, vol. xxxvi., 1898.]

## XLII.

NOTE ON THE EFFECT OF HEAT ON INFUSIBLE IMPALPABLE  
POWDERS.

[*Proceedings of the Royal Society of Edinburgh, January 29, 1877.*]

SEVERAL years ago Professor Dewar gave me a specimen of silica in a state of exceedingly minute division, which had been produced in Dr Playfair's laboratory in the preparation of flosilicic acid. I noticed at the time how much its great mobility is increased by heating—so that it behaves almost like a liquid. And I fancied that I observed close to the surface a thin stratum of what might by the same analogy be called a vapour; consisting of particles thrown up and falling back again, like the little drops thrown up at the surface of soda-water. I was inclined to ascribe these phenomena to heat directly—supposing that the particles were fine enough to behave, though in a very imperfect way, as the kinetic theory assumes the particles of a gas to behave. However this may be, the extreme mobility of such powders when heated on a platinum dish; and the fact, noticed by chemists, that a bath of calcined magnesia is capable of propagating waves when heated; seem to show that valuable results might be obtained by seeking for evidence of interdiffusion as the result of experiments made by very long-continued heating of vessels containing fine silica and magnesia originally in separate strata. I have brought this before the Society in the hope that (as it can hardly be classed as a laboratory experiment) some of the Fellows, who may have access to a suitable furnace which is in activity the greater part of the year, may be induced to give the experiment a fair trial.

### XLIII.

#### NOTE ON AN IDENTITY.

[*Proceedings of the Royal Society of Edinburgh, June 4, 1877.*]

WHATEVER be  $p$  and  $q$  it is obvious that

$$\frac{1}{p} = \frac{1}{q} + \frac{q-p}{q} \cdot \frac{1}{p}.$$

Hence

$$\frac{1}{p} = \frac{1}{q_1} + \frac{q_1-p}{q_1} \left( \frac{1}{q_2} + \frac{q_2-p}{q_2} \cdot \frac{1}{p} \right),$$

and so on. Finally we see that

$$\begin{aligned} \frac{1}{p} = & \frac{1}{q_1} + \frac{q_1-p}{q_1} \cdot \frac{1}{q_2} + \frac{q_1-p}{q_1} \cdot \frac{q_2-p}{q_2} \cdot \frac{1}{q_3} + \dots \\ & \dots + \frac{q_1-p}{q_1} \cdot \frac{q_2-p}{q_2} \dots \frac{q_{n-1}-p}{q_{n-1}} \cdot \frac{1}{q_n} + \frac{q_1-p}{q_1} \cdot \frac{q_2-p}{q_2} \dots \frac{q_n-p}{q_n} \cdot \frac{1}{p}, \end{aligned}$$

absolutely without any restriction on the values of the quantities involved.

It is obvious that an immense number of curious results in the form of sums of series, &c. can be derived with great ease from this expression and from various modifications of it. I give, therefore, only a few very simple examples.

Take  $q_1, q_2, \&c.$ , as the first  $n$  of the natural numbers, and the series becomes

$$\begin{aligned} \frac{1}{p} = & 1 - \frac{p-1}{2} + \frac{p-1}{2} \cdot \frac{p-2}{3} - \dots \\ (-)^{n-1} & \frac{p-1}{2} \cdot \frac{p-2}{3} \dots \frac{p-n+1}{n} (-)^n \frac{p-1}{1} \cdot \frac{p-2}{2} \dots \frac{p-n}{n} \frac{1}{p}, \end{aligned}$$

whence at once the sum of the first  $n+1$  terms of the expansion of  $(1-1)^p$  is seen to be

$$(-)^n \frac{p-1}{1} \cdot \frac{p-2}{2} \dots \frac{p-n}{n}.$$

We obtain merely the same result if we take  $q_1, q_2, \&c.$ , as any set of consecutive whole numbers; but from the theorem itself it is easy to obtain the equality,

$$\begin{aligned} \frac{p}{r} \left\{ 1 + \frac{p+r}{r+1} + \frac{p+r}{r+1} \cdot \frac{p+r+1}{r+2} + \dots + \frac{p+r}{r+1} \dots \frac{p+s-1}{s} \right\} \\ = \frac{p+r}{r} \cdot \frac{p+r+1}{r+1} \dots \frac{p+s}{s}. \end{aligned}$$

Next, write the general identity as follows:—

$$\begin{aligned} \frac{1}{p} = \frac{1}{q_1} + \frac{p}{q_2} \left( \frac{1}{p} - \frac{1}{q_1} \right) + \frac{p^2}{q_3} \left( \frac{1}{p} - \frac{1}{q_1} \right) \left( \frac{1}{p} - \frac{1}{q_2} \right) + \dots \\ + \frac{p^{n-1}}{q_n} \left( \frac{1}{p} - \frac{1}{q_1} \right) \dots \left( \frac{1}{p} - \frac{1}{q_{n-1}} \right) + p^{n-1} \left( \frac{1}{p} - \frac{1}{q_1} \right) \dots \left( \frac{1}{p} - \frac{1}{q_n} \right). \end{aligned}$$

If in this we write each letter for its reciprocal we have

$$p = q_1 + \frac{q_2}{p}(p - q_1) + \frac{q_3}{p^2}(p - q_1)(p - q_2) + \&c.,$$

of which a particular case is the curious formula

$$\begin{aligned} p = 1 + 2 \left( 1 - \frac{1}{p} \right) + 3 \left( 1 - \frac{1}{p} \right) \left( 1 - \frac{2}{p} \right) + \dots \\ + n \left( 1 - \frac{1}{p} \right) \left( 1 - \frac{2}{p} \right) \dots \left( 1 - \frac{n-1}{p} \right) + p \left( 1 - \frac{1}{p} \right) \dots \left( 1 - \frac{n}{p} \right). \end{aligned}$$

Another is

$$\begin{aligned} 1 = \cos \theta + \cos 2\theta (1 - \cos \theta) + \cos 3\theta (1 - \cos \theta) (1 - \cos 2\theta) + \dots \\ + \cos n\theta (1 - \cos \theta) \dots (1 - \cos (n-1)\theta) \\ + (1 - \cos \theta) (1 - \cos 2\theta) \dots (1 - \cos n\theta), \end{aligned}$$

of which a very interesting case is given by  $n\theta = 2\pi$ .

As a final example we have the singular formula

$$\frac{1}{x-y} = \frac{1}{x} + \frac{y}{x(x+1)} + \frac{y(y+1)}{x(x+1)(x+2)} + \dots \&c.$$

whence it follows that, subject to the introduction of the remainders as above (which vanish if the series are extended to infinity, and if  $x > y$ ),

$$\begin{aligned} \left( \frac{1}{x} + \frac{y}{x(x+1)} + \frac{y(y+1)}{x(x+1)(x+2)} + \dots \right) \left( \frac{1}{x} - \frac{y}{x(x+1)} + \frac{y(y-1)}{x(x+1)(x+2)} + \dots \right) \\ = \frac{1}{x^2} + \frac{y^2}{x^2(x^2+1)} + \frac{y^2(y^2+1)}{x^2(x^2+1)(x^2+2)} + \dots \end{aligned}$$

By another application of the formula we may easily obtain finite expressions for the sum of the series of which two successive terms are

$$\frac{y(y+1)\dots(y+r-1)}{x(x+1)\dots(x+s-1)} \text{ and } \frac{y(y+1)\dots(y+r)}{x(x+1)\dots(x+s)}.$$

I obtained the first expression above by integrating *by parts* a power such as  $x^{p-1}$ , but the following mode of obtaining it shows at once its nature.

Let there be a number of independent events,  $A, B, \dots N$ , whose separate probabilities are  $\alpha, \beta, \dots \nu$ . Then the chance that one at least of them occurs is

$$1 - (1 - \alpha)(1 - \beta) \dots (1 - \nu).$$

But we may obtain another expression for the same result by writing the chance that any one (say  $A$ ) occurs, adding to that the chance that another (say  $B$ ) occurs while  $A$  does not occur, then that  $C$  occurs and neither  $A$  nor  $B$ , &c. This gives

$$\alpha + \beta(1 - \alpha) + \gamma(1 - \alpha)(1 - \beta) + \dots$$

Equating these two expressions we get an identity which is easily transformed into that first given.

But its truth is much more easily seen if we write  $\alpha'$  for  $(1 - \alpha)$ , &c., when the last given form becomes

$$1 - \alpha'\beta'\gamma' \dots = 1 - \alpha' + (1 - \beta')\alpha' + (1 - \gamma')\alpha'\beta' + \dots$$

which is an obvious truism. The method seems well worth the attention of any one with leisure and some analytical skill.

July 24.—Mr Muir has kindly given me a reference to *Crelle*, vol. XII. p. 354, where it is stated that the above identity in one of its forms is in Schweins' "Analyse," p. 237. This work I have not seen. Mr Muir adds that no developments or applications of the theorem are made.

## XLIV.

## NOTE ON VECTOR CONDITIONS OF INTEGRABILITY.

[*Proceedings of the Royal Society of Edinburgh, December 3, 1877.*]

(1) THE relation

$$d\sigma = uq d\rho q^{-1}$$

ensures that the tensor of  $d\sigma$  shall always be  $u$  times that of  $d\rho$ . Hence, if  $\rho$  be the common vector of three series of surfaces which together cut space into cubes,  $\sigma$  possesses the same property. (See § 6 of my paper "On Orthogonal Isothermal Surfaces," No. XXV. above, p. 180. In what follows this paper will be referred to as  $\Omega$ .)

We may suppose the tensor of  $q$  to be any constant, unity say. Then, from

$$Tq^2 = 1,$$

we have

$$S \cdot dqKq = S \cdot dq q^{-1} = 0.$$

Thus, it appears that  $q^{-1} \cdot dq$  and its equal  $-dq^{-1} \cdot q$

are vectors.

(2) From the given equation we have

$$\frac{d\sigma}{dx} = uqi q^{-1} \text{ and } \frac{d\sigma}{dy} = ujj q^{-1}.$$

From these  $q^{-1} \frac{d^2\sigma}{dx dy} q = i \frac{du}{dy} + 2uV \cdot i \frac{dq^{-1}}{dy} q = j \frac{du}{dx} + 2uV \cdot j \frac{dq^{-1}}{dx} q.$

From the three equations of this form we obtain by the operations  $S_i, S_j, S_k$ , nine scalar equations, of which the following are three:—

$$\frac{du}{dx} = 2uS \cdot k \frac{dq^{-1}}{dy} q,$$

$$\frac{du}{dy} = -2uS \cdot k \frac{dq^{-1}}{dx} q,$$

$$S \cdot j \frac{dq^{-1}}{dy} q = -S \cdot i \frac{dq^{-1}}{dx} q.$$

The last of these, with its two similar equations, shows that

$$S \cdot i \frac{dq^{-1}}{dx} q = S \cdot j \frac{dq^{-1}}{dy} q = S \cdot k \frac{dq^{-1}}{dz} q = 0,$$

which express Dupin's theorem for this particular case.

(3) If we put for simplicity

$$dv = \frac{du}{2u}$$

the equations of last section give at once three like

$$\frac{dq^{-1}}{dx} q = V \cdot i \nabla v,$$

so that

$$dq \cdot q^{-1} = V \cdot d\rho \nabla v \dots\dots\dots[\Omega (33)],$$

and

$$\nabla q^{-1} \cdot q = \Sigma \cdot i V i \nabla v = -2 \nabla v = -\frac{\nabla u}{u},$$

or

$$\nabla \cdot u q^{-1} = 0 \dots\dots\dots[\Omega (13)].$$

(4) But we have, by differentiation, from the second equations of § 3,

$$\frac{d^2 q^{-1}}{dx dy} q + \frac{dq^{-1}}{dx} \cdot \frac{dq}{dy} = \frac{d}{dy} V \cdot i \nabla v,$$

$$\frac{d^2 q^{-1}}{dy dx} q + \frac{dq^{-1}}{dy} \cdot \frac{dq}{dx} = \frac{d}{dx} V \cdot j \nabla v.$$

Subtracting, and noticing that

$$\frac{dq^{-1}}{dx} \cdot \frac{dq}{dy} = -q^{-1} \frac{dq}{dx} \cdot q^{-1} \frac{dq}{dy},$$

we have

$$2V \cdot q^{-1} \frac{dq}{dx} q^{-1} \frac{dq}{dy} = V \cdot \left( j \frac{d}{dx} - i \frac{d}{dy} \right) \nabla v = V \cdot V(k \nabla)_i \nabla v,$$

or

$$-2S(k \nabla v) \cdot \nabla v = V \cdot V(k \nabla) \nabla v.$$

Three like this give at once  $(\nabla v)^2 = -\nabla^2 v$

$$0 = 2u \nabla^2 u - (\nabla u)^2 = 4u^{\frac{3}{2}} \nabla^2 (u^{\frac{1}{2}}) \dots\dots\dots[\Omega (21)].$$

T.

(5) But if, instead of combining the last set of three, we equate to zero the scalar coefficients of  $i$ ,  $j$ ,  $k$  separately in each, we have three equations of each of the following forms:—

$$2 \frac{dv}{dx} \frac{dv}{dy} = \frac{d^2v}{dx dy}, \quad \frac{d^2v}{dx^2} + \frac{d^2v}{dy^2} = -2 \left( \frac{dv}{dz} \right)^2.$$

Transformed to  $u$ , they become

$$2 \frac{du}{dx} \frac{du}{dy} = u \frac{d^2u}{dx dy}, \quad \&c.,$$

$$u \left( \frac{d^2u}{dx^2} + \frac{d^2u}{dy^2} \right) = \left( \frac{du}{dx} \right)^2 + \left( \frac{du}{dy} \right)^2 - \left( \frac{du}{dz} \right)^2, \quad \&c.$$

The integrals of the first three are obviously

$$\frac{1}{u^2} \frac{du}{dx} = X', \quad \frac{1}{u^2} \frac{du}{dy} = Y', \quad \frac{1}{u^2} \frac{du}{dz} = Z',$$

where the right-hand members are functions of  $x$ ,  $y$ ,  $z$  respectively. Thus

$$\frac{1}{u} = -X - Y - Z$$

and the first of the second set of three equations becomes

$$u^3 (X'' + Y'' + 2uX'^2 + 2uY'^2) = u^4 (X'^2 + Y'^2 - Z'^2),$$

or

$$X'' + Y'' = -u (X'^2 + Y'^2 + Z'^2).$$

Thus

$$X'' = Y'' = Z'' = C,$$

and

$$\frac{1}{u} = -\frac{C}{2} [(x-a)^2 + (y-b)^2 + (z-c)^2] + C',$$

or, as we may take the origin where we please,

$$u \propto \frac{1}{CT\rho^2 + D}.$$

This is, therefore, the *only* value of  $u$  which satisfies the conditions of the problem, and the last equation in § 4 above shows that  $C$  or  $D$  must vanish. If  $C$  vanish,  $u$  and  $q$  are both constant.

(6) If  $D$  vanish, we have by § 3 above

$$-dq \cdot q^{-1} = V \cdot d\rho \frac{\nabla u}{2u} = -V \frac{d\rho}{\rho} = -dU\rho \cdot (U\rho)^{-1}.$$

This gives

$$q = aU\rho$$

where  $a$  is any constant versor.



Also

$$d\sigma = \frac{c^2}{T\rho^2} a U \rho d\rho (U\rho)^{-1} a^{-1} \\ = -ad \left( \frac{c^2}{\rho} \right) a^{-1},$$

so that  $\sigma$  is the *Electric Image* of  $\rho$  rotated through any angle about any axis through the centre of the reflecting sphere. ( $\Omega$  § 12.)

(7) If the equations of any three systems of *orthogonal* surfaces be

$$F_1 = C_1, \quad F_2 = C_2, \quad F_3 = C_3,$$

we may obviously write for the flux of heat through each the expressions

$$\nabla F_1 = u_1 q i q^{-1}, \quad \nabla F_2 = u_2 q j q^{-1}, \quad \nabla F_3 = u_3 q k q^{-1};$$

so that we have three equations of the form

$$\nabla (u_1 q i q^{-1}) = a_1,$$

where  $a_1, a_2, a_3$  are *scalars*, which separately vanish when the systems are *isothermal*.

Expanding the last equation we have

$$\frac{\nabla u_1}{u_1} q i q^{-1} + \nabla q \cdot q^{-1} \cdot q i q^{-1} + q i q^{-1} \nabla q \cdot q^{-1} - 2S (q i q^{-1} \nabla) q \cdot q^{-1} = \frac{a_1}{u_1},$$

or, writing

$$q i q^{-1} = i',$$

$$\frac{\nabla u_1}{u_1} i' + 2S \cdot i' \nabla q q^{-1} - 2S (i' \nabla) q \cdot q^{-1} = \frac{a_1}{u_1}.$$

We obtain Dupin's Theorem in its most general form by operating by  $S \cdot i', S \cdot j', S \cdot k'$  on this and the two similar equations respectively. It is thus expressed as three equations, of which one is

$$S \cdot i' S (i' \nabla) q \cdot q^{-1} = 0.$$

Again, by multiplication by  $i'$ , and by adding the other two equations multiplied by  $j'$  and  $k'$  respectively, we obtain also

$$\sum \frac{\nabla u}{u} + 2 \sum i' S i' \frac{\nabla u_1}{u_1} - 2V \cdot \nabla q q^{-1} + 2 \nabla q \cdot q^{-1} = \sum \frac{a_1 i'}{u_1}$$

or

$$\sum \frac{\nabla u}{u} + 2V \cdot \nabla q q^{-1} + 2 \nabla q \cdot q^{-1} = - \sum \frac{a_1 i'}{u_1},$$

whence

$$S \cdot \nabla q q^{-1} = 0,$$

and

$$\sum \frac{\nabla u}{u} + 4 \nabla q \cdot q^{-1} = - \sum \frac{a_1 i'}{u_1}.$$

When the systems are isothermal as well as orthogonal, this equation may be put in the singular form—

$$\nabla [(u_1 u_2 u_3)^{\frac{1}{2}} q] = 0.$$

The results given in this section were laid before the Society in May, 1876, but were mislaid, with other papers then read.

(8) The great desideratum in the application of quaternions to problems such as those just treated, seems to lie in the discovery of the general solution of the equation

$$\nabla r = 0,$$

where  $r$  is a quaternion. Unfortunately this seems to depend ultimately upon Laplace's equation, treat it how we may. It is easily seen to be equivalent to the kinematical problem of finding a displacement which shall produce no compression, but shall produce a rotation whose vector axis is derived from a potential.

The nature of the difficulty is also easily seen in another way; for, when we try to find the conditions of integrability of such an equation as

$$V. \lambda d\mu = d\nu,$$

we may, of course, make the assumption

$$d\mu = \phi d\rho$$

where the coefficients of  $\phi$  are functions of  $\rho$ . This gives at once

$$S\alpha d\mu = S. \phi' \alpha d\rho,$$

so that

$$V. \nabla \phi' \alpha = 0$$

whatever constant vector be  $\alpha$ .

Suppose this satisfied, we have the farther condition

$$V. \lambda \phi d\rho = d\nu,$$

or

$$S. \phi' V(\alpha \lambda) d\rho = S\alpha d\nu,$$

so that, whatever be  $\alpha$ ,

$$V. \nabla \phi' (V\alpha \lambda) = 0.$$

Taken in conjunction with the former condition, this shows that  $\nabla$  may here be considered as operating on  $\lambda$  only.

In this very particular case, however, we find at once that  $\lambda$  must be constant, and that

$$d\mu = \phi d\rho = i du + j dv + k dw.$$

## XLV.

## NOTE ON A GEOMETRICAL THEOREM.

[*Proceedings of the Royal Society of Edinburgh, January 7, 1878.*]

IN *Trans. R.S.E.* (1864-5) Fox Talbot proved very simply, by means of a species of co-ordinates depending on confocal conics, the following theorem, at the same time asking for a simple geometrical proof.

*If two sets of three concentric circles, with the same common difference of radii, intersect one another—the chords of the arcs intercepted on the mean circle of each series by the extremes of the other are equal.*

A properly geometrical proof may possibly be obtained by showing that the *middle points* of these arcs are equidistant from the line joining the centres. It is, of course, quite easy to build up a quasi-geometrical proof, but Talbot's would be much better.

The following investigation shows the nature of the theorem, and gives some elegant constructions.

Let  $d$  be the common difference,  $b$  and  $c$  the mean radii, and  $a$  the distance between the centres. Then the square of one of the chords is easily seen to be

$$p^2 = 2c^2 (1 - \cos (\theta' \pm \theta)),$$

where  $\theta'$  and  $\theta$  are given by

$$(b - d)^2 = a^2 + c^2 - 2ac \cos \theta,$$

$$(b + d)^2 = a^2 + c^2 - 2ac \cos \theta'.$$

The expressions for the other chords differ only by the interchange of  $b$  and  $c$ . Elimination gives at once

$$\begin{aligned} p^2 &= 2c^2 \left\{ 1 - \frac{a^2 + c^2 - (b-d)^2}{2ac} \cdot \frac{a^2 + c^2 - (b+d)^2}{2ac} \right. \\ &\quad \left. \mp \left\{ 1 - \left( \frac{a^2 + c^2 - (b-d)^2}{2ac} \right)^2 \right\}^{\frac{1}{2}} \left\{ 1 - \left( \frac{a^2 + c^2 - (b+d)^2}{2ac} \right)^2 \right\}^{\frac{1}{2}} \right\} \\ &= \frac{1}{4a^2} \{ 4(a^2 + d^2)(b^2 + c^2) - 2(b^2 - c^2)^2 - 2(a^2 - d^2)^2 \\ &\quad \mp 2(4a^2c^2 - (a^2 + c^2 - (b-d)^2)^{\frac{1}{2}}(4a^2c^2 - (a^2 + c^2 - (b+d)^2)^{\frac{1}{2}}) \} \\ &= \frac{4}{a^2} (A^2 + A'^2 \mp 2AA'), \end{aligned}$$

where  $A$  and  $A'$  are the areas of the "inscribable" quadrilaterals, crossed and uncrossed, whose sides are  $a, b, c, d$ . This, of course, proves Talbot's theorem.

Hence 
$$p^2 = 4 \frac{(A' \mp A)^2}{a^2},$$

a remarkably simple expression. The two values of  $p$  are given at once by Talbot's diagram, and the rectangles under their quarter sum, and difference, respectively, with the distance between the centres, give the areas of the quadrilaterals above mentioned. Or, better, the triangles whose angular points are the middles of the arcs respectively, and the centres, have areas equal to half the sum and half the difference of the quadrilaterals.

The symmetry of these expressions shows that in Talbot's theorem any two of the four quantities employed may be interchanged—the lengths of the corresponding pairs of equal chords being always inversely as the quantity chosen for the distance between the centres of the two series of circles.

Again, it is easy to see that we have by the above equations

$$\begin{aligned} A' &= ac \sin \frac{\theta'}{2} \cos \frac{\theta}{2}, \\ A &= ac \cos \frac{\theta'}{2} \sin \frac{\theta}{2}, \end{aligned}$$

so that, construct the figure how we will with four given lines, the ratio of the tangents of the halves of the pair of angles corresponding to  $\theta, \theta'$ , is constant. This is the relation between True and Excentric Anomaly. And we have also the very simple expression

$$AA' = \frac{a^2c^2}{4} \sin \theta \sin \theta',$$

so that the product of the areas of the crossed and uncrossed quadrilaterals is equal to the product of the areas of the (construction) triangles whose sides are

$$a, c, b - d,$$

and

$$a, c, b + d,$$

respectively. Here again the letters may be interchanged at will; which, in itself, is a curious theorem.

While seeking a quaternion proof of the above theorem, I hit upon the following result. Given two opposite sides of a gauche quadrilateral in magnitude and direction. If one of these be fixed, and if the diagonals are to be of equal lengths, the locus of either end of the other is a plane.

## XLVI.

NOTE ON THE SURFACE OF A BODY IN TERMS OF A  
VOLUME-INTEGRAL.

[*Proceedings of the Royal Society of Edinburgh, January 21, 1878.*]

IN § 25 of my paper on "Green's and other Allied Theorems" (No. XIX. above) I gave the following relation between a volume and a surface integral, the limits being determined by any simply connected closed space:—

$$\iiint \nabla \tau ds = \iint U \nu \tau ds.$$

If in this equation we assume  $\tau$  (which is arbitrary) to be equal to  $U\nu$  at every point of the surface, we have

$$\tau = U\nu = U\nabla P$$

where  $P=C$  is the (scalar) equation of the surface. The equation then becomes

$$\iiint \nabla U (\nabla P) ds = - \iint ds.$$

Applied to the ellipsoid—

$$\frac{x^2}{a^2} + \frac{y^2}{b^2} + \frac{z^2}{c^2} = 1,$$

this gives for the whole surface the expression—

$$\iiint dx dy dz \frac{\frac{x^2}{a^4} \left( \frac{1}{b^2} + \frac{1}{c^2} \right) + \frac{y^2}{b^4} \left( \frac{1}{c^2} + \frac{1}{a^2} \right) + \frac{z^2}{c^4} \left( \frac{1}{a^2} + \frac{1}{b^2} \right)}{\left( \frac{x^2}{a^4} + \frac{y^2}{b^4} + \frac{z^2}{c^4} \right)^{\frac{3}{2}}},$$

the limits being given by the equation of the surface.

## XLVII.

NOTE ON THE STRENGTH OF THE CURRENTS REQUIRED TO  
WORK A TELEPHONE.

[*Proceedings of the Royal Society of Edinburgh, February 4, 1878. Deferred from  
January 7.*]

PERHAPS the most singular fact connected with the telephone is the excessive feebleness of the currents which suffice to work it. I have had no opportunity of testing any but rough arrangements set up by present or former students of my own, so that I cannot judge how far my results may apply to the instrument as sold.

1. A striking illustration of the feebleness of the currents required is furnished by using a Holtz machine driven *very* slowly, without condenser, and with its terminals so close that the discharge is barely audible, and certainly invisible except in the dark. When insulated wires were led from these terminals to the telephone (placed in a distant room) the effect was very curious. The instrument gave a hissing sound, quite comparable in intensity with that which was produced directly when the terminals of the machine were widely separated, one connected with the ground and the other with a large conductor discharging by brushes into the air, the machine being turned rapidly. The telephone continued to give audible sounds with slow turning, even when the terminals of the machine (somewhat tarnished) were *pressed into contact*.

2. To measure roughly the intensity of the current, I placed one prong of an unmagnetised tuning-fork about half an inch in front of the sending telephone, and measured by a microscope and scale the extent of its vibrations when the note just ceased to be audible to a listener at the receiving telephone. Next I substituted for the receiving telephone an exceedingly delicate astatic galvanometer, with very small moment

of inertia, and measured the swing produced by one definitely assigned motion of the prong of the tuning-fork. By means of a known thermo-electric couple, I determined the strength of the current corresponding to the observed swing. The result is, of course, only a very rough approximation. It is that a single Grove's cell would produce, in a circuit of somewhere about a billion B.A. units resistance, a current sufficient, if reversed 500 times per second, to produce an audible sound in the telephone I employed.

3. Several attempts at explanation of the action of the telephone have been given here and elsewhere, and others are promised for to-night. For my own part, I think there are at least *three* separate causes at work in the telephones I have used.

There can be no doubt that the inventor's own explanation is, at least to a certain extent, correct. For we can easily dispense with the magnet in the receiving telephone, using merely a thin iron disc in front of a coil. And Mr Blyth has, I believe, found that we may make the disc, even in this case, of copper, and yet have transmission (though very feeble) of intelligible sounds.

But this cannot be the full explanation. For it does not attempt to account for the peculiar nasality of the transmitted speech. Without going more closely into the matter, the difference of quality between an open and a closed pipe suggests a certain amount of constraint as the cause. And we know that the sounds in the original telephone of Reiss were produced by molecular motions due to magnetism in soft iron. Mr Blyth has shown conclusively that molecular motion in the magnet itself has a large share in the results, because he has successfully substituted other metals than iron, and even non-conductors, for the disc, and in certain cases finds that he can dispense with the disc altogether.

Besides this, however, it seems to me that there is a third cause, which in certain cases is more effective than either of the others. This is suggested by the fact that (at least with the instruments I have tried) high notes, even of comparatively small intensity, are much more clearly transmitted than low notes,—indicating that the *rapidity* of the molecular change has a great deal to do with the result. In fact, in this respect, the telephone is really a variety of the so-called *curb-key*, giving very sudden reversals.

These considerations have led me to fancy that *rapid* change of form in matter, whether paramagnetic or not, may probably be capable of detection by the telephone, for the associated electric currents may be in certain cases powerful enough to produce audible sounds. I am at present engaged in a series of preliminary experiments on this subject.



## XLVIII.

## THERMAL AND ELECTRIC CONDUCTIVITY.

[*Transactions of the Royal Society of Edinburgh*, Vol. xxviii.]

(§§ 1-16, Read March 18, 1878—Revised (from a Shorthand Writer's extended Notes) December 4, 1878.)  
(§§ 17-23, Read June 3, 1878.)

THE following paper contains the results of an inquiry which has occupied me at intervals for somewhere about ten years. It was carried out in part at the expense of the British Association, and I have already reported results to that body in 1869 and 1871. But these provisional reports referred to very short ranges of temperature only, and the experiments were made with faulty thermometers, for which I had not the corrections which had been carefully determined by Welsh at Kew.

The inquiry arose from my desire to extend to other metals the very beautiful and original method which Principal Forbes devised, and which the state of his health prevented him from applying to any substance but iron. Forbes' experiments gave a result so very remarkable, and (as it seemed to me) so theoretically suggestive, that I wished to extend them to other pure metals, and also, in one or two cases at least, to alloys.

I believe that Principal Forbes had at least two reasons for undertaking his investigations:—(1) When he commenced his inquiry, there was no really accurate or trustworthy determination of the absolute conductivity of any body whatever for heat. (2) Forbes had himself, in 1833\* and subsequent years, pointed out a very remarkable analogy between the conducting powers of metals for electricity and for heat, and had shown that these were almost precisely proportional to one another—that is to say, that the list of the average relative conductivities of different metals for electricity

\* *Proc. R.S.E.*, i. 5.

differed, from that of their relative conductivities with regard to heat, certainly not more than did the several electric lists furnished by different experimenters, and certainly less than did the corresponding thermal lists. Hence it was natural to suppose that temperature might have a marked effect on thermal conductivity, as it was known to have such an effect on electric conductivity.

The great merit of Forbes' method\* is, that it seeks the conductivity in terms of its definition; instead of seeking a value of the conductivity which will best satisfy the integral of Fourier's equation formed on the hypothesis of uniform conductivity, and of loss of heat from the surface of the bar in direct proportion to the temperature-excess above the surrounding air. Although Forbes' paper has been printed in the Transactions of this Society†, I may make a few additional remarks on the methods he employed.

He used for the first part of the experiment, what he called the *statical experiment*, a bar of iron, 8 feet long by  $1\frac{1}{4}$  inch square section. One end of this was raised to a high temperature by means of a pot containing melted solder, whose temperature was maintained nearly constant for eight or nine hours. The rest of the bar was exposed to the air of the laboratory, and of course parted with a portion of the heat conducted to it partly by radiation, partly by convection. It was found that after about eight hours a stationary distribution of temperature was attained, in which the net gain of heat in any section of the bar by conduction was just neutralized by the surface loss. This temperature distribution was then accurately determined. In the second or *dynamical experiment*, a shorter bar, of exactly the same transverse dimensions, was employed; not, however, for the conduction of heat, but for the purpose of ascertaining at what rate its heat was lost by radiation and convection at different temperatures. For this purpose the bar was heated as uniformly as possible, once for all, and then allowed to cool in the air, its temperature being noted at measured intervals of time. The introduction of the experiments with the shorter bar was the main point of great importance in which Forbes improved the *experimental* part of the determination. And, as regards the subsequent calculations, it need only be said, to show the improvement he introduced, that had he followed Biot's mode of procedure he would probably have failed to discover that thermal conductivity (in some cases at least) depends on temperature. As I have already said, though Forbes' results were confined to iron, they were the first of any real value to the absolute measurement of thermal conductivity.

§ 1. Viewed in the light of the results attained, I do not now think so much as I was originally disposed to do of one of the chief reasons which led me to the present inquiry. But that does not in any way matter to my other chief reason; for, though an attractive hypothesis has been shown to be untenable, at all events without very considerable restrictions, some valuable and even curious measurements have been made. Forbes' results for iron have been, in all but one particular, closely reproduced by myself, but their most striking peculiarity, the falling off of conductivity

\* Report B.A., 1852.

† Trans. R.S.E., 1860-61, and 1864-5.

with rise of temperature is, so far as I yet know, confined to the single metal which he experimented on. I had fancied that as the numerical results given by him seemed closely consistent with a conductivity varying inversely as the absolute temperature, such might be generally the case. Inquiring into possible physical reasons for this, I saw that if it were assumed that, in the steady linear propagation of heat, the amount of available energy of the heat in three successive slices of a solid, of equal thickness, were always the lowest possible, consistent with the conditions of the experiment, Forbes' result would follow, and would give, in fact, an excellent instance of dissipation of energy. [See No. XIV. above. 1898.]

§ 2. The subjects I set myself to inquire into were definitely these—

(1) Whether in pure metals there is always a decrease of thermal conductivity with a rise of temperature. And for this purpose I chose the metals copper and lead, because we can easily and at small expense procure them in large quantity and in a state of great purity.

(2) Whether different specimens of the same metal may not differ in thermal conductivity, at least as widely as they are known to do in electric conductivity; and for this purpose, in consequence of Sir W. Thomson's\* remarkable observations on the electric conductivity of copper, I selected copper.

(3) Whether an alloy, such as is chosen for resistance coils because its electric conductivity changes little with change of temperature, does not show a similar small change of thermal conductivity; for this purpose I chose the alloy, German silver, which is frequently used for such coils.

(4) A fourth question, which I have not yet answered, was whether there may not be some conduction-peculiarity in a substance whose specific heat varies little with temperature. This was suggested to me by the theoretical notions above alluded to, and probably falls with them. For such a purpose there can be no doubt that the best substance is platinum, because its specific heat is known to alter very little; and Messrs Johnston and Matthey were kind enough to offer to provide me with a bar of platinum of the same dimensions as Forbes' iron bar, at the comparatively small expense of working the material into the necessary form and working it down again. The value of the material of such a bar, it may be well to mention, would have been about £2000.

§ 3. The results I have hitherto published in the Reports of the British Association were, of course, strictly preliminary. For, besides the want of scale-errors for my thermometers, another great difficulty felt at the commencement of the experiments was that of maintaining a nearly constant temperature in the source of heat for the statical experiment. At the time I gave those provisional reports, I had operated only with temperatures not much higher than that of boiling water; through a range, in fact, barely sufficient to indicate with certainty a *change* of conductivity even in iron.

\* *Proc. R.S.*, 1857 (June 15).

§ 4. Shortly after Forbes published the full result of his experiments on iron, another excellent and novel method, quite distinct in principle from his, was described by Ångström\*. Of that method I availed myself, with the help of the various bars and thermometers obtained for the present inquiry. In Ångström's method it is so much more easy to calculate out the results, and derive the conductivity from the experiments, than in that of Forbes, that I have already—in 1872-73†—communicated to the Society the results obtained by this method, though I had years before made some of the experimental determinations required by Forbes' method, whose numerical consequences are only now produced. But my thermometers, though excellent for the use of Forbes' method, were not nearly delicate enough for the proper application of that of Ångström. It requires, for its successful carrying out, the very accurate reading of small *changes* of temperature. Hence the results of 1872-73 can be looked upon as at best but very rough approximations. One great defect of Ångström's method, as compared with that of Forbes, lies in the assumption (which forms part of its necessary basis) that the rate of surface loss is proportional directly to the excess of temperature over the surrounding air. Even for the moderate range of temperature employed in Ångström's experiments‡, this is not nearly correct. Hence, and for other reasons (for instance, his equations being formed as if  $k$  were constant), I do not accept his statement that the thermal conductivity of copper falls off as the temperature rises, as one which his method was competent to decide. Even with Forbes' much superior method, a range of at least 100° C. is absolutely necessary to settle such a point.

I have had several reasons for delay in publishing the results of these experiments. For the most part, the experiments themselves were made eight or nine years ago, but for the delay with regard to the calculations I am not wholly responsible. Since I obtained the assistance of Mr Evans, however, there has been no unnecessary delay in the computations. Experimental difficulties of various kinds were, however, constantly cropping up. Besides the difficulty already alluded to, of maintaining a steady temperature of the source of heat, a very peculiar difficulty arose from the behaviour of the thermometers. These, after being exposed to high temperatures and cooled, showed a gradual rise of the zero points; and, in some of those which have been most frequently exposed to the highest temperatures, the zero point has risen as much as about five degrees. There were also very great difficulties about the heating of the short bar for the cooling experiment. Here my results were very different (at high temperatures) from those of Forbes. Again, the lead and copper, and sometimes (in extreme cases), even the iron and German silver, when highly heated, become oxidised, and the coating of oxide on the surface promotes radiation, if not also convection; and as the surface becomes oxidised to different amounts at different temperatures no one set of experiments with the short bar is strictly comparable with anything but one part of the long bar. That difficulty is not so much felt in the case of the iron, still it is felt to a certain extent in the case of all the metals tried. My results are all somewhat uncertain on this account. This uncertainty, and means of removing it, are discussed in § 13.

\* *Pogg. Ann.*, 1862. *Phil. Mag.*, 1863, 1. † *Proc. R.S.E.* ‡ *Pogg. Ann.*, Band 118, 1863.

Another reason for the delay that has occurred in producing the results has been my endeavouring—to a certain extent fruitlessly—to give the results in terms of *absolute temperature*, by the help of air-thermometers. Much time has been spent on that work, yet, even with the assistance of Dr Joule and others, I have not been able to get a really good set of determinations. The real difficulty lies in the fact that the holes cut in the bars for the insertion of the bulbs of thermometers are necessarily so small, that it is not possible to construct any efficient air-thermometer which can be made to take the place of the mercurial ones.

I have been assisted in the experimental part of the work by several of my Laboratory students; but most especially by my mechanical assistant, Mr T. Lindsay, who has been throughout the inquiry as valuable to me as was his father to Forbes.

§ 5. The results now given are founded, some of them on experiments made before 1871, and some on experiments made last year. The calculations have all been carried out with care and accuracy by Mr Evans (who used the processes described by Forbes), and their results have been verified by myself, partly by graphical methods, partly by various devices for interpolation, and in the majority of instances by calculation also\*. But, as will be seen, I content myself at present with the statement of probable values only. I have only now arrived at nearly definite conclusions as to the best mode of working, after having pushed to the extreme admissible limit every part of the process.

Before giving the results, it may be well to detail with some care the particulars in which my apparatus and modes of experimenting differ from those employed by Forbes.

\* One of these interpolation methods is so easily applied, and (in consequence of the usual nature of the statical curves) gives results so fairly approximate, that it must be mentioned here as of great use if only in checking the results of the more complex calculations.

Let  $v_1, v_2, v_3, v_4$ , be the observed temperatures shown by the four thermometers, placed at intervals of three inches on the long bar. Let  $w$  be the number of degrees lost per minute by the thermometer in the short bar, when its temperature-excess above the air is nearly that of  $\frac{1}{2}(v_2 + v_3)$ . Then the conductivity at the temperature  $\frac{1}{2}(v_2 + v_3)$ , in terms of the units employed in § 15 below, is very approximately

$$\frac{w}{8(v_1 - v_2 - v_3 + v_4)}.$$

[This formula assumes *third* differences of  $v_1$  to vanish.] With a single bar of 20 inches, or so, in length (with four or more holes three inches apart), to be used alternately for the statical and for the dynamical experiment (in the former with its free end artificially cooled), I believe that very fair determinations of thermal conductivity may be made in a few hours by the use of the above formula. Had I known this ten years ago I should not have undertaken the repetition and extension of Forbes' experiments *under conditions exactly similar to his*. But, on the other hand, had I not undertaken this work, I should probably not have fallen upon this simple method.

I believe that it may be found applicable even to stout wires or rods, the temperatures being observed by a thermo-electric process. Thus these determinations may be made for very rare metals, and also for substances of very low conductivity. I hope, with the assistance of a party of my Laboratory students, to get a large number of metals examined by this method during next winter and summer sessions.

§ 6. With regard to the bars employed—The iron bar experimented on was that last made for Forbes' experiments. My chief object in employing this bar was, of course, to ascertain how nearly I could reproduce Forbes' results; with the view of obtaining, as far as I had the means of doing so, a check upon my own work. A couple of copper bars were procured for me, at the instance of Mr Willoughby Smith, from a firm largely engaged in furnishing copper cores for submarine cables. These were of the same dimensions as Forbes' iron bar but, while one (*Crown*) was made of copper of the highest electric conductivity, the other (*C*) was made of copper of the worst conductivity. The only difference in construction between these copper bars (as well as the other bars which I employed) and Forbes' iron bar, consisted in the necessary protection of the metal from the mercury which was employed to surround the bulbs of the thermometers when inserted in the holes. For this purpose it was necessary that the holes should be lined with iron; and, therefore, little cups like the heads of arrows are sunk into the copper, lead, and German silver bars. The thickness of the iron shell is so small that it is not sufficient to influence in the slightest measurable degree the progress of the heat along the bar. The copper was in the *hard* state. I propose, at some future time, when some of the desiderata after-mentioned are supplied, to have these bars *annealed* and repeat the measurement of their conductivity.

Along with the copper bars just described, I received some specimens of wire for electric testing. These were said to be made of the same materials. My experience of them has not been satisfactory, as different specimens from the same material show considerable differences in electric conductivity. I therefore defer the consideration of the electric conductivity of these materials till I have time to test for this purpose the long bars themselves.

The German silver bars, long and short, were cut from an exceedingly fine casting, procured for me by the late Mr Becker. Its transverse section is of exactly the same dimensions as the others. The bars of lead were cast by Messrs Milne, and are in all respects like the others, save that the bar for the statical experiments is not so long. It required special additional supports to prevent flexure.

The bar of gas-coke upon which some experiments have been made, was sawn from a block of coke obtained from Mr Young of the Dalkeith gas-works. The bar is exactly of the same transverse section as the other bars employed, but though only a few inches in length, it was found sufficient. Even with the highest temperature applied at one end, after 10 hours exposure, there was scarcely any perceptible heating at the further end. The same bar served first for the statical experiment, and then was heated again for the cooling experiment.

§ 7. In procuring the thermometers, on whose accurate indications the whole value of the experimental work depends, I availed myself of the assistance of Dr Balfour Stewart, who was then director of the Observatory at Kew. Two sets of thermometers were made under his supervision, one set with long range and short degrees, the other with short range and long degrees, and all were tested by him.

I had wished as far as possible to carry out Forbes' idea that it was better to use thermometers, even if they did not show the zero point, which even at high temperatures exposed only a small quantity of mercury in the stem, than to have a long column exposed to the air, with its temperature of course very different at different parts. Dr Balfour Stewart, however, told me that, so far as he knew, it was impossible accurately to graduate thermometers under these conditions; and he advised me to take the thermometers as he could make them and guarantee them, namely, mercurial ones, made of proper glass, carefully divided by graduating instruments at Kew, and showing  $0^{\circ}$  C. As this is a point of vital importance, I append in a foot-note an extract from Dr Stewart's letter\*.

I have already spoken of the circumstance that when the bulbs of some of these thermometers had been heated several times to over  $200^{\circ}$  C., and especially when heated more than once to nearly  $300^{\circ}$  C., their indications began to be permanently altered in the way of increase; and in some of them which had been exposed in the holes or bores, closest to the source of heat, where they had been often raised to a temperature of  $300^{\circ}$  centigrade, it was found that the permanent alteration of zero was as much as 5 degrees. As it appeared that the probable nature of the distortion was a permanent shrinkage of the bulb, I calculated what should on that supposition be the behaviour of the instrument at different temperatures; and by comparing its indications step by step with those of another of the thermometers which had not been distorted by violent heating, I found the results of calculation verified. The altered instrument loses slightly to the other, so that at  $300^{\circ}$  C. it is little more than four degrees in advance instead of the five it had at zero.

But, after all, this change of error (for the altered instruments were used for the higher temperatures only) can be easily allowed for in correcting the readings for scale-errors; and it is very small in comparison with other inevitable errors of the determination. To mention only one of these, a very slight inexactitude in the position of the hole bored for one of the higher thermometers would involve a more serious error. And, in the mercury, or fusible metal, in each hole there is a most peculiar distribution of temperature, due to the fact that one side of the hole is very considerably hotter than the other.

§ 8. I have already mentioned the very great difficulty encountered in obtaining a properly uniform source of heat in the statical experiment. I tried various processes

\* *Extract from a letter, Dr STEWART to Prof. TAIT.*

“KEW OBSERVATORY, 8th December 1868.

.....“We have come to the conclusion that each instrument ought to go down as low as the freezing point.

“It is possible, no doubt, starting with an instrument that includes the freezing point in order to determine the graduation constants, and afterwards taking out some mercury, to produce instruments that begin to register only at high temperatures. But there is an element of uncertainty introduced in taking out the mercury, which may not only cause a constant error, but an error of scale value.....

(Signed) “B. STEWART.”

depending on boiling points, and all sorts of gas regulators, without success, until I got a very valuable suggestion from Dr Crum Brown. The principle is excessively simple, but in working it was found to be almost perfect. It rendered quite unnecessary the constant watching described by Forbes. All that was required was a reading of the whole set of thermometers every hour or half-hour.

The following extract from my note-book tells its tale sufficiently:—

*Gas lit at 6.25 A.M.*

	12h. 25m. P.M.	1h. 11m.	1h. 51m.	2h. 58m.
Temperature at hole nearest source,	299	301	301·1	301

In fact, during the last three hours of the experiment referred to, the temperature, though about 300° C., varied by only about one-tenth of a degree. This was actually less than the change of temperature of the air of the room. Of course this, and a few others like it, are exceptional cases; but not possible, even as such, with any other arrangement I have tried. As a rule, a change of *at most* three degrees in the temperature shown by the thermometer nearest the source (and this change a very gradual one) was the utmost fluctuation during the last three hours in the great majority of the experiments. In the few cases in which there was a greater change, it was traced at once to the “burning-down” of one or more barrels of the six-barrelled Bunsen I employed. In such cases, the experiment was at once stopped, and the record crossed out.

Nothing more satisfactory could have been expected in a matter so very difficult as that of regulating the gas supply, when, as all know, in a town like Edinburgh, the pressure is sometimes varied arbitrarily by an amount almost equal to one-third or one-fourth of the whole; and where, especially towards dusk, there are very sudden

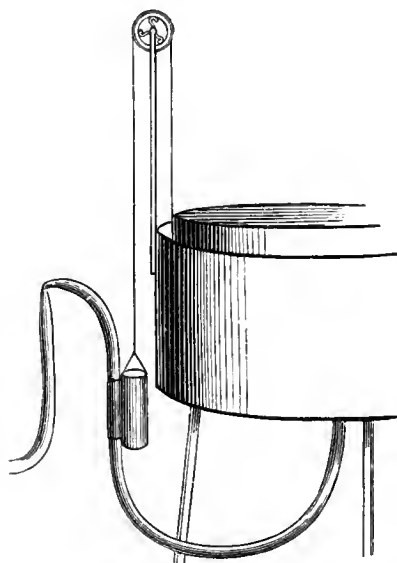

changes, partly due to increased pressure in the gasometers, partly to the rapid lighting of many burners. The process employed by Crum Brown is to cut off, or increase, the supply of gas to a small gasholder by a sort of valve which acts almost instantaneously. The valve consists of an india-rubber tube, which is just on the point of being *nipped*—that is, being bent over so as almost completely to close it. A very slight motion of one end effects the difference between nipping and comparative openness, so that when this tube is appended to one of the weights of the gasholder, it maintains a perfectly regular pressure in the holder. In fact, it was not possible to observe, from half-hour to half-hour, any variation of level of the inverted vessel.

The theory of this application is that, where absolute regularity or steadiness cannot be had, the



best substitute for it is extreme stability of equilibrium. There is, no doubt, a constant change going on, but any displacement produces such a disproportionately great force of restitution as practically to keep everything steady.

§ 9. Another source of great difficulty, which had been fully felt by Forbes, was the heating of the short bar. The method he finally adopted is perhaps not applicable, except to iron: at least when high temperatures are required. He plunged his iron bar bodily into a bath of melted fusible metal. The bar was wrapped in paper to prevent too sudden an abstraction of heat from the melted metal. I first tried to heat the bars by means of a sort of air-bath, but I found that in such a bath they all became oxidised before the temperature was sufficiently raised. I endeavoured to overcome this difficulty by putting successive covers on the bath, making it, in fact, almost air-tight, and passing a uniform current of dry carbonic acid gas through it.

These methods proved comparative failures, and the simple process ultimately adopted consisted in taking a brass gas-pipe, pierced along its upper side by a number of holes at equal intervals from one another. This burner was connected directly with the gasometer and produced a row of little jets. As these were of gradually diminishing intensity (in consequence of diminishing pressure), the tube was slightly inclined upwards from the gasholder. The bar (previously raised to a temperature of about  $100^{\circ}$ , by radiation from a fire, to prevent deposition of moisture from the flames) was placed over it in a horizontal position on a sort of rack, on which it was kept turning round and round, until it was very uniformly heated; being occasionally turned end for end. It was found that when the bar was not heated above  $200^{\circ}$  C., but little oxidation was produced during the time required for the heating. When it was necessary to raise the temperature higher, the nature of the effect on the surface was described by its colour, which was noted and compared with the effect found to be produced on different parts of the corresponding long bar by its more gradual heating. It would be very easy to burn a mixture of gas and air, and so to a great extent get rid of the possibility of smoking the surface, but practically it was found that no insuperable difficulties were introduced by taking the ordinary coal-gas. But, for a reason presently to be mentioned, the short bars had always to be raised to a temperature much higher than that at which the readings of the thermometers commenced. Thus all my results must necessarily be a little too large, as the cooling was in every case observed on a bar more oxidised than the portion of the long bar which had the same temperature.

§ 10. With reference to the estimation of the true temperature of the bulbs of the thermometers from the readings of a variably heated stem, the great difficulty experienced was one felt by Forbes also—one which he endeavoured to get rid of by detaching arbitrarily a column of mercury, and throwing it up into the little bulb at the top of the thermometer, thus working from an arbitrary zero. Dr Balfour Stewart told me it was almost impossible to get trustworthy results from the thermometer so treated, and I determined to take my chance of the insufficient heating of the column of mercury in the thermometer, which was not directly

immersed in the mercury in the holes in the bar. I do not think very much error can be introduced by this, for the following reasons. If we calculate for a temperature of  $250^{\circ}\text{C}$ .—which is nearly the highest used in the greater number of the experiments—the utmost error that can be introduced in the indications of the thermometers used is somewhere about  $10^{\circ}\text{C}$ . That is to say, the highest temperatures were read at the most  $10^{\circ}$  less than they would have been if the whole thermometer had been exposed to the same temperature. This correction of  $10^{\circ}$  at  $250^{\circ}$  diminishes at lower temperatures, and increases at higher nearly as the square of the excess of temperature above the freezing point. But as the same thermometers, or exactly similar ones, were employed, under precisely\* similar conditions, in the short bars as in the long ones, the *difference* between the corresponding errors in the two associated experiments must have been at most a fraction of a degree even at the higher temperatures. The numerical results, therefore, are stated in terms of the temperatures *so read*, and these involve (from this cause) an error in defect, of somewhere about  $10^{\circ}$  at  $250^{\circ}\text{C}$ ., and varying for other temperatures as above stated. I have preserved all the notes of experiments, as well as the thermometers, as it may ultimately be possible to get an air-thermometer which will enable me to reduce the determinations to a more accurate standard; but until that can be done it seems hopeless to expect to improve (in this particular) the method I have employed, however important might be the results.

§ 11. There is one respect, and one only, in which my results have been found to be not quite consistent with those of Forbes. This is in regard to the law of cooling of the short bar in terms of the temperature. Forbes, in fact, called special attention to this question, and he evidently felt considerable surprise at the result he obtained, for he tried it over and over again with the same conclusion. Although he pointed out that the initial uniformity of temperature of the heated bar would tend to produce the *appearance* of such a result, Forbes expressed himself as convinced that the curve representing the rate of cooling of the short bar in terms of the *temperature* begins to be straight about  $150^{\circ}\text{C}$ ., and then bends over so as to become convex upwards. I have carried it considerably farther, in fact, up to estimated temperatures of at least  $300^{\circ}\text{C}$ ., without finding the slightest trace of convexity. It is obviously essential that this discrepancy should be explained; and I think it depends on the fact that Forbes did not heat his short bar much above the temperature ( $200^{\circ}\text{C}$ . or thereabout) at which the readings commenced. Under these circumstances the flow of heat from the interior of the bar is for some time retarded; in fact, till a state of things is arrived at in which the temperatures at different distances from the axis or from the ends of the bar cease to undergo a rapid *relative* change, the inserted thermometer does not indicate the true loss of heat by the bar. I think that this explanation is borne out by the fact that Forbes' results, with a bar of smaller section and length (in which the abnormal state is of shorter duration), agree more nearly with mine, so far at least as change of rate of cooling is concerned.

\* Jan. 13, 1879. In spite of the contents of § 11\*, now added, this is nearly true of my experiments, for the highest of the thermometer readings in the cooling bars were not used in the calculations.

I easily reproduced Forbes' results by heating the bar only to the temperature at which the readings commenced. But to avoid this source of error I always, when it could be done, raised the temperature much above the point at which readings were to begin, so as, in fact, to read only when the normal state of cooling had been arrived at. In some of my experiments with iron the bar was heated to such an extent that mercury boiled furiously when put into the hole—and I had to employ fusible metal instead. In all cases I obtained results resembling those of Forbes during the first few minutes of cooling.

The following short table illustrates this difference, as well as the fact stated in § 9 that my numbers are *all* a little too high. The first column gives the temperature-excess over the air; the second contains the rate of cooling as given by Forbes; the third column contains results obtained (for the same temperatures) by a rough graphic method from my own numbers. The rates are in degrees C. per minute:—

*Rates of cooling of Iron Bar.*

			Ratio.
20°	0·275	0·29	1·06
50°	0·80	0·85	1·06
100°	1·84	1·95	1·06
160°	3·18	3·45	1·09
200°	3·78	4·60	1·22
260°	4·52	6·50	1·44

I have every reason to believe that Forbes' results, in this matter, for temperatures under 150° C. are more exact than mine, especially as his bar was not exposed to air during the heating. Thus it would appear that my numbers are, *throughout*, about 5 or 6 per cent. too high. The really vital difference between our results appears in the three last numbers in the column of ratios.

[§ 11\*. *Added, January 1879.*]—I was so well satisfied with the explanation given above, as in character thoroughly consistent with the observations, that I did not work out its numerical consequences. While the paper was passing through the press, however, I tried to estimate the time required for the disappearance of the abnormal state, and arrived at conclusions which are not quite consistent with this mode of accounting for the difference between Forbes' results and my own. To make this statement intelligible, a short account of Fourier's treatment of the problem is necessary.

The equation for the cooling of an infinitely long cylinder, in which the temperature depends only upon the distance from the axis, is (assuming conductivity constant)

$$k \left( \frac{d^2v}{dr^2} + \frac{1}{r} \frac{dv}{dr} \right) = \frac{dv}{dt}.$$

This linear equation Fourier integrates by assuming as a particular integral

$$v = \epsilon^{-mt} u$$

where  $u$  is a function of  $r$  only. We thus have

$$\frac{d^2 u}{dr^2} + \frac{1}{r} \frac{du}{dr} + \frac{m}{k} u = 0.$$

The surface condition (assuming rate of surface-loss to be proportional to excess of temperature over air) is

$$k \left( \frac{du}{dr} \right)_0 + hu_0 = 0.$$

From the first of these equations we have  $u$  in terms of  $m$  and  $r$ . The second gives an infinite number of real positive values of  $m$ , say  $m_1, m_2, \&c.$ , in ascending order of magnitude, in terms of  $r_0$  (the radius of the cylinder),  $k$ , and  $h$ . Now  $h$  is easily found (approximately) from the rate of cooling, and  $k$  is known. Hence we determine the values of  $m$ , and have

$$v = A_1 \epsilon^{-m_1 t} u_1 + A_2 \epsilon^{-m_2 t} u_2 + \dots$$

where the coefficients ( $A$ ) are to be calculated so as to make  $v$  agree with the initial state when  $t=0$ .

Without doing this, however, it is obvious that the proposed explanation given above depends for its validity on the supposition that  $m_2$  is not enormously greater than  $m_1$ ; for, if it be, the abnormal terms due to the original uniform heating will disappear with very great rapidity.

A rough calculation showed me that  $m_2/m_1$  for the iron bar lies between 2000 and 3000. Hence the bar is barely out of the bath before these abnormal terms have become insensible. The effect due to the finite length of the bar is easily calculated by the help of Fourier's method for a cube, which applies to a rectangular parallelepiped of any dimensions, symmetrically heated. It depends on the fact that the temperature at any point can be expressed as the product of three functions, each containing the time and *one* only of the coordinates. I owe this hint to Professor Chrystal.

Calling  $2a, 2b, 2c$  the edges of the parallelepiped, this method leads to the following expression—

$$v = 64v_0 \Sigma \left( \frac{\sin na \cos nx}{2na + \sin 2na} \epsilon^{-kn^2 t} \right) \cdot \Sigma \left( \frac{\sin n'b \cos n'y}{2n'b + \sin 2n'b} \epsilon^{-kn'^2 t} \right) \cdot \Sigma \left( \frac{\sin n''c \cos n''z}{2n''c + \sin 2n''c} \epsilon^{-kn''^2 t} \right),$$

where the values of  $n, n', n''$  are the roots of

$$na \tan na = \frac{ha}{k}, \quad n'b \tan n'b = \frac{hb}{k}, \quad n''c \tan n''c = \frac{hc}{k},$$

and  $v_0$  is the initial uniform temperature.

With the data contained in the present paper, it is easy to obtain from the above the following values of  $\frac{1}{v_0} \frac{dv}{dt}$  corresponding to a uniform initial temperature ( $v_0$ ) of about 200° C., the bar being  $1\frac{1}{4}$  inches square, by 20 inches in length, and only the slower vanishing terms being retained:—

$$\begin{aligned} \text{Iron} & \dots\dots\dots - 0.0235e^{-0.0235t} (1 - 0.068e^{-0.16t}) \\ \text{Copper (Crown)} & \dots\dots - 0.0262e^{-0.0262t} (1 - 0.06e^{-1.06t}). \end{aligned}$$

Hence the rate of cooling is diminished initially as regards the longitudinal flux of heat by above 5 per cent. in both bars. [The omitted terms reduce this by one-fourth, *at first*.] In copper this is diminished to 1 per cent. (less than the errors of observation) in less than two minutes, so that it cannot be traced in any of the observations, as certainly two minutes must elapse after the heating before readings can commence. In iron the error is reduced to 2 per cent. after about six minutes; so that to this cause is due a part, but only a small part, of the difference between Forbes' results and mine. For the initial sluggishness of cooling is exhibited by copper as well as iron, so that there must be another and more effective cause besides longitudinal cooling.

I next tried (but without the least hope that it would help me) whether the discrepance might not be due to the fact that Fourier assumes  $k$  to be constant. If we assume (for the range of temperature employed)

$$k = \frac{ak_0}{a + v}$$

which is not far from the truth, the equation is no longer linear, even for the infinitely long cylinder\*. But I found that this would not account for the result to be explained, and that no substitution of a more accurate law of cooling than that adopted by Fourier would remove the difficulty.

Thus I was driven to seek the main cause of the phenomenon in the thermometer, not in the bar, and I traced it to the fact that the mercury in the bulb is all but fully heated almost at once, but that the final adjustment in the bulb and stem takes place more gradually. No previous heating of the bulb will much help in such a case.

To test this explanation I heated the short iron bar, and immersed a thermometer bulb at once in one of the holes, reading it, as usual, every minute. After six minutes had elapsed, I inserted a second thermometer in a hole very near the first, and read it at half time between the continued readings of the first. After another period of six minutes a third thermometer was inserted close to the others. The result has fully verified the correctness of my conjecture. The following table,

\* It is interesting, however, to know that it can be transformed into

$$ak_0 \left( \frac{d^2\phi}{dr^2} + \frac{1}{r} \frac{d\phi}{dr} \right) = \epsilon^\phi \frac{d\phi}{dt}$$

which differs only by the factor  $\epsilon^\phi$  on the right from the equation for constant conductivity.

graphically calculated from the readings, explains itself. *A* refers to the first-mentioned thermometer, *B* to the second, *C* to the third. The thermometers were read as soon as they ceased to rise.

*Rates of cooling of the same bar, simultaneously indicated by thermometers whose bulbs had been immersed for different periods.*

Temperature-excess.	<i>A</i>	<i>B</i>	<i>C</i>
210° C.	5·15		
200°	4·98		
190°	4·75		
180°	4·42	4·10	
170°	4·06	3·89	
160°	3·70	3·61	3·28
150°	3·33	3·28	3·18
140°	2·96	2·91	2·88

NOTE.—For this experiment the bar, which was much discoloured, was not polished previous to heating; so that the numbers are necessarily larger than those in § 11 above. This does not affect the *relative* results.

In each of these columns the differences are obviously least at the top, and the corresponding points of inflection in the curves of cooling are obviously at temperatures which are the lower, the colder was the bar when the thermometer was inserted. Also, it will be observed that the thermometers arrive more quickly at the true temperature the lower it is—*i.e.*, the shorter the column of mercury in the stem. Another experiment gave analogous results with a copper bar. Thus the main difference between Forbes' results and mine is fully explained.

One result of this discussion is that in heating the short bars it is more important to prevent oxidation than to secure absolute uniformity of heating. Another is that the hypothesis of uniform temperature in the cross-sections of the long bar is practically very near the truth.

§ 12. In the treatment of the *Statical Curves* I have always used, as Forbes did, the formula

$$\log v = A - \frac{Bx}{1 + Cx}.$$

It is easy to work with, and its results are usually accurate within the unavoidable errors of other parts of the determination.

Where, as with the iron and the German silver bars, the nature of the problem admitted it, I have constructed graphically each of two curves of statical distribution for the same metal (with the solder at very different temperatures), and, to the same abscissæ as the values of *v*, the calculated values of *dv/dx*. One of these drawings

was on tracing paper, and was superposed upon the other, with the view not merely of detecting possible errors in the calculations, but also of testing how far the results might be trusted. On this point I have no remarks to offer further than this, that the values of  $dv/dx$  for the lower temperatures, must, when they are small, as a rule be determined *graphically*.

When the highest temperature (observed) was over  $300^{\circ}$  C., it was impossible to reconcile it with the curve deduced by means of the above formula from the indications of the three succeeding thermometers. As this was obviously due to the rapid expansion of mercury near its boiling point, the irreconcilable observation (sometimes as much as  $10^{\circ}$  above the curve mentioned) was not taken into account.

§ 13. The *Curves of Cooling* were at first treated in the same way. But they had to be broken up into several sections, and it was not easy to decide (without great additional labour) how to obtain the most trustworthy value of the rate of cooling at a point common to two sections, from the more or less discordant values obtained from the separate formulæ for the sections.

I next tried to treat them by taking three points with abscissæ in arithmetical progression, and determining the common quantity to be subtracted from their ordinates, so that the intervening arc might be treated as *logarithmic*. [Forbes used the logarithmic curve, but he endeavoured to make it pass through three points without subtraction from their ordinates.]

This is a very good method so far as results go, and might be applied to all the different curves required for these experiments. But I found that, though the details which it involves are easy, even practised calculators were liable to get confused with their multiplicity.

Finally, for my own revision of the whole work, I adopted the following method. I constructed a curve, usually with  $5^m$ ,  $10^m$ , and  $20^m$  intervals for the abscissæ, whose ordinates were  $\frac{1}{10}$ th of the *changes* of temperature during the  $5^m$  periods, or  $\frac{1}{10}$ th of the changes for the  $10^m$  periods, &c. The scale for ordinates was usually much larger than that for abscissæ. The points so determined did not, of course, give a very smooth curve (especially where successive readings at intervals of  $1^m$  or  $2^m$  came to be within one or two tenths of a degree of a division on the scale), but it was very easy to draw a smooth curve so as to equalize the errors, and the ordinates of this curve are at once the desired values of rates of cooling. This process has proved exceedingly successful. It is very much less tedious, and much less liable to large error, than any other at all accurate one—and its results compare favourably with those obtained by the other methods above. I believe that this process, applied to the cooling of bars, especially if one be of platinum, will give good results as to change of specific heat with temperature.

I have already stated that as the short bars were always necessarily heated much above the temperatures at which their cooling was observed, my results are a little too large. The only really serious case is that of the copper bars. But for these the

curve of cooling was observed *through the same range* for very different degrees of initial heating, and it was found that the only effect of oxidation was to increase all the ordinates through that range in a slowly increasing ratio, so that the assumed correction for oxidation was easily made, and probably pretty accurate. I cannot, however, feel certain that I have in all cases applied it rightly. It is not at all easy to pronounce on an equality of oxidation of two bars (so far as our present purpose is concerned) unless both be employed for the cooling experiment.

Forbes expressed an opinion (which I do not share) against electro-plating the bars to prevent oxidation. I intend to try this method; and also, if possible, the wrapping of the bar in thin sheet iron, so as to employ Forbes' bath of solder. I have made several experiments with bars *smoked*. The method promises well, except perhaps in the case of copper, but the calculations are not yet effected.

§ 14. The *Statical Curves of Cooling* were constructed exactly as described by Forbes. But there are two remarks of some importance to be made upon the mode of obtaining their areas.

In the first place, they are not even approximately logarithmic, except for small intervals. And even then the axis is not usually the asymptote. Their area between two ordinates is usually greater than that of a logarithmic with the same axis and passing through the two corresponding points.

Secondly,—It is a matter of great difficulty to determine what to allow for the portion, in theory infinitely long, but finite in area, which extends beyond the point of lowest observation of temperature on the long bar:—except in the case of the copper bars, where the temperature was kept at the further end *lower* than that of the surrounding air. The end of the bar was introduced into a large vessel of gutta-percha full of water, which was constantly renewed from below by means of a pipe connected with a large cistern. Thus the values of  $dv/dx$  were never very small at any observed part of the bar.

The question here raised is a very important one. It is not at all probable that the thermal conductivity should, *in all the substances I have examined*, begin to change very much more rapidly below  $50^{\circ}\text{C}$ . than it had been changing during the whole range to that point from  $200^{\circ}\text{C}$ . or even from  $300^{\circ}\text{C}$ . Hence, when I found the conductivity to be well represented between these limits (in terms of the temperature) by a straight line, I have ignored (as almost certainly due to errors inseparable from the method employed) the somewhat marked and rapidly increasing curvature, which is indicated in many cases, for the lower  $20^{\circ}$  or  $30^{\circ}$  of observed temperatures. I justify this proceeding on the ground that (in addition to the fact that the areas, the smaller ones especially, are underrated by treating the curve as logarithmic) very slight differences in the quantity allowed for the infinitely prolonged area (a quantity whose value we can only guess at) make all the difference between a rapidly increasing curvature and a rapidly diminishing one (sometimes even with a point of contrary flexure), while barely affecting the run of the higher and much more extensive part



of the curve. This remark does not require (as will be seen) to be applied to the case of iron, which appears to be a thoroughly exceptional one,—though manifest indications of it are to be seen in Forbes' diagram of the conductivities of the bar when naked and when covered with paper. Another cause may have some effect here. The excesses of temperature above that of the air are so small that an inevitable error of even  $0^{\circ}\cdot 1$  may produce a serious effect on the calculated result.

If I have sufficient leisure, in the course of next session, I hope to settle this point by using a cold water bath applied near the *middle* of each of the iron, German silver, and lead bars, the source of heat being kept at as high a temperature as in the experiments already made. I now believe from experience that in measuring conductivity, at whatever temperature, things ought to be arranged so as to avoid any very slow flux of heat. And I also think that, especially for very good conductors, such as copper, the bars should be smoked.

§ 15. With these observations I submit the following values, by no means as final even so far as my own work is concerned but, as probably fair approximations to the truth. The units are the foot, minute, and degree centigrade, the unit of heat being that required to raise the temperature of a cubic foot of the substance by  $1^{\circ}$  C., at each of the specified temperatures. [See the end of this section.]

IRON.

Temperature C.	Conductivity.	F.
0	0·0149	(0·0190)
50	0·0138	0·0131
100	0·0128	0·0115
150	0·0121	0·0107
200	0·0114	0·0100
250	0·0109	0·0094
300	*0·0105	0·0089
350	*0·0102	...

The two numbers marked with an asterisk are merely *probable* deductions from the curve representing the others. They are introduced to show the difference in character between my results and those of Forbes, due mainly to the difference in our estimates of the rate of cooling at high temperatures. The column headed F. is (graphically) interpolated from Forbes' table (*Trans. R.S.E.*, 1864, p. 102), which refers to the same bar under the same conditions. This table does not extend below  $17^{\circ}$  C., so that the number in brackets is to some extent conjectural. It is inserted to illustrate what I have said in § 14 above as to the rapid change of conductivity indicated when temperature excesses are small.

My numbers seem to point to a temperature, somewhere about red-heat, at which the thermal conductivity of iron (measured as above) is a minimum,—but this is altogether uncertain.

## COPPER.

	Crown.	C.
0	0·076	0·054
100	0·079	0·057
200	0·082	0·060
300	0·085	0·063

I have already (§ 13 above) stated that uncertainty must attach to all these determinations of conductivity of copper at high temperatures on account of the different amounts of oxidation of the short bars and of different parts of the long bars. The small increase of conductivity with rise of temperature, here shown, *may* depend upon too great a rate of cooling having been adopted for the hotter parts of the long bars.

## GERMAN SILVER.

0	0·0088
100	0·0090
200	0·0092
300	0·0094

The several experiments on German silver, both statical and dynamical, did not show so satisfactory an agreement as those on the other bars. A set of mean values is therefore given.

## LEAD.

0	0·0152
100	0·0160

The experiments on lead have not been conducted through a sufficient range of temperature to make the change here indicated certain.

The experiments on gas-coke proved a failure. The method is not adapted to substances of such low conductivity.

To convert these numbers to the usual unit of conductivity, they must be multiplied by the specific gravity and the specific heat of each substance: and also by the number of pounds in a cubic foot of water, if heat is to be measured in the usual thermal unit. The former constants I have as yet determined only roughly, and not for very great ranges of temperature. I need scarcely, therefore, add that in the calculations no heed has been taken of the change of specific heat with temperature. This would *increase* the values of  $k$  at higher temperatures, and thus reduce the change in conductivity in iron, and increase the small changes indicated for the other substances.

§ 16. As the above results, though the outcome of a very protracted investigation, are, for reasons already stated, only provisional, I do not think it necessary to print the details of the observations, graphical constructions, or calculations. Several points must be thoroughly cleared up before more definite statements can be made. Meanwhile the MS. of the whole work is placed at the disposal of the Society.

§ 17. To determine the electric conductivity of the bars above described, I employed, in succession, three different methods. The results of these separate methods agreed with one another quite as well as did results by any one method made on different portions of the same bar. The German silver bar is the least uniform of the metallic bars, portions of it of 10 inches length at different parts varying through a range of as much as 5 per cent. in their conductivity. Slight defects in the casting, some of which are visible at the surface, of course easily account for this. I give the average value.

Neither the absolute nor the relative electric conducting powers of these bars were found to agree at all well with those of wires (said to be of the same material) which were furnished to me along with them. Hence some of my earlier statements to the *British Association* (especially with regard to copper) were inaccurate. The fortunate circumstance that I had no wire said to be of the same material as the Forbes iron bar, led me to test all the thick bars themselves for their electric conductivity.

§ 18. The first process I employed was that described by Sir W. Thomson (*Proc. R.S.* 1861). The principle of the method will be easily seen from the following diagram.

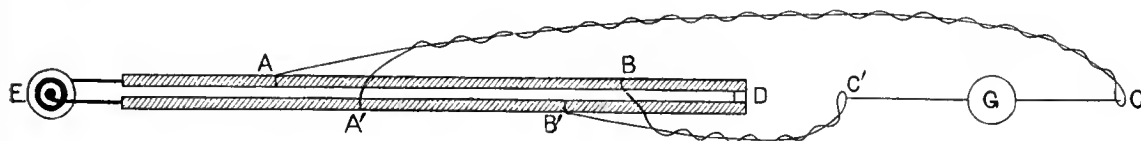

The bars to be compared are placed parallel to one another, and connected by a small resistance  $D$  at one end, while the poles of a single cell  $E$  (sometimes short-circuited) are applied to the other ends for a period usually very short. Points  $A, A', B, B'$ , are joined by resistances, *similarly divided* in  $C, C'$ ; and these latter points are connected with the terminals of a sensitive galvanometer whose coil has a resistance, large in comparison with that of any other part of the arrangement.

Under these conditions, if  $i$  be the current in the battery, the current in the galvanometer coil is (to a sufficient approximation),

$$\frac{i}{g} \left\{ \frac{aq - bp}{a + b} + \left( \frac{a}{a + b} - \frac{\alpha}{\alpha + \beta} \right) c \right\}.$$

Here the resistances are  $AC = a, CA' = b, BC' = \alpha, C'B' = \beta, AB = p, A'B' = q, BDB' = c$ , galvanometer =  $g$ . If, for instance,  $a = b, \alpha = \beta$ , very exactly, and if we adjust  $B'$  till there is no deflection, we have then

$$p = q,$$

*i.e.*,  $AB$  and  $A'B'$  have equal resistance. For accuracy by this method we must have, as Thomson has pointed out,  $a/b = \alpha/\beta$  very accurately, and  $c$  very small.

§ 19. The second and third methods which I employed require a differential galvanometer. This was very exactly adjusted, before the experiments, by putting the coils in multiple arc, and using the cell on them without a shunt. The exact balance was obtained by means of a box of resistance coils inserted in one or other of the branches. This being done, I connected one coil with  $A, B'$ , and the other with  $A', B$ . Here the effect is approximately proportional to

$$i \left( \frac{q+c}{g} - e \frac{p+c}{g'} \right),$$

where  $g$  and  $g'$  are the resistances in the galvanometer coils, and  $e$  is the ratio of their deflecting forces on the needle when equal currents pass through them. The adjustment above described makes, very accurately,

$$g' = eg,$$

and the joint effect on the needle is therefore as

$$\frac{i}{g} (q - p).$$

Shifting  $B'$  as before till there is no deflection, the resistances  $AB, A'B'$  are equal.

§ 20. But I find by trial, that by far the most expeditious and simple method is to connect the coils of the differential galvanometer directly with  $A, B$  and  $A', B'$ . Here the deflection is *accurately* proportional to

$$i \left\{ \frac{q}{g+q} - e \frac{p}{g'+p} \right\}$$

so that the resistance  $c$  is not involved. I found, in fact, that I could, without sensible alteration of the balance, put for  $c$  (which, in addition to short portions of the thick bars, was usually a brightly polished cube of copper of the same section as the bars, and clamped very tightly between them), a short thin wire, which became red-hot when the current was allowed to pass for a few seconds. Nothing but absolutely *perfect* adjustment could have made this possible when using the other methods.

In my experiments the most unfavourable case gave

$$g > 30,000 q,$$

so that  $q$  and  $p$  are practically equal when there is no deflection.

§ 21. I employed the bar C. of inferior copper in all these comparative experiments. But the conductivity of the German silver bar is so much less that I could employ only 10 inches of it, as against 7 feet of the inferior copper. I therefore endeavoured, by experiments on short lengths of the two copper bars, to find approximately the correction required, in consequence mainly of the breadth of my contact pieces, very slightly, perhaps, in consequence of the great section of the bars. Here are the results in inches,—

C. A'B'.	Crown. AB.	Uncorrected.	Ratio. Corrected.	Mean of Corrected.
49.66	85.7	1.726	1.732	} 1.729
48.47	*83.5	1.723	1.729	
41.47	71.25	1.718	1.725	
18.8	32.2	1.713	1.728	
16.65	*28.46	1.709	1.731	
9.25	15.7	1.697	1.729	

[NOTE.—In the experiments marked with an asterisk the arrangement was altered by shifting the crown bar to the other coil of the galvanometer. The agreement of these with the others is a good guarantee of the accuracy of the adjustments, and the goodness of the method is seen in the fact, that no observation deviates so much as  $\frac{1}{2}$  per cent. from the mean. This is a striking verification of what was said above about the small effect of the holes bored in the bars, for the nippers were placed quite at random in the various experiments.]

The contact pieces were nippers of polished copper, 0.42 inch broad, which were easily slipped along the bars, and were tightened on them by screw clamps when the final adjustment was nearly arrived at.

It appears from the column of *corrected* ratios above, that it is only necessary to subtract 0.4 inch (the sum of the half breadths of the nippers, the wires being soldered to them symmetrically) from each of the measured distances to secure almost perfect uniformity. Thus I was led to see that the influence of the section of the copper bars is almost undiscoverable by such experiments.

§ 22. For the Forbes iron bar the following results were obtained (but with the correction 0.2 inch):—

Fe.	C.	Uncorrected.	Ratio. Corrected.
20	74.3	3.715	3.74
10	37.3	3.73	3.79
5	18.4	3.68	3.79

For German silver (mean of several experiments at different parts of the bar, with correction 0.2 inch),—

G. S.	C.	Uncorrected.	Ratio. Corrected.
10	84.1	8.41	8.56

For lead (also with the correction 0.2 inch),—

Pb.	C.	Uncorrected.	Ratio. Corrected.
14	93.7	6.69	6.77
10	66.9	6.69	6.80

These experiments were repeated for me by Mr D'Arcy Thompson, who used, as contact pieces, plates of copper pressed edgewise against the long bars in planes

perpendicular to their axes. His results differ in no case from mine before the third significant figure.

§ 23. Taking the inferior copper as unit, both for thermal and for electric conductivity, we find the following table of conductivities at ordinary temperatures, with the rough results as to specific gravity and specific heat referred to in § 15 above:—

	Thermal.	Electric.
Copper (Crown) . . . . .	1·41	1·729
„ C. . . . .	1·00	1·000
Forbes' Iron . . . . .	0·29	0·264
Lead . . . . .	0·12	0·149
German Silver . . . . .	0·14	0·117

The agreement of these numbers is by no means so close as is generally stated; but this is no longer remarkable, for it is well known that the electric conductivity of all pure metals alters very much with the temperature, while we have seen that, as regards thermal conductivity, there is but slight change with either copper or lead, though there is a large change with iron. This accords with some results of my own on the electric conductivity of iron at high temperatures (*Proc. R.S.E.*, 1872-3, p. 32), and with the results of the repetition of these experiments by a party of my laboratory students (*Proc. R.S.E.*, 1875-6, p. 629).

The only alloy treated above, violates, as was to be expected, Forbes' rule for pure metals, for it seems to be superior to lead in thermal conductivity, while decidedly inferior to it as regards electric conductivity.

§ 24. The chief results of these papers may be thus briefly summarised:—

1. *The thermal conductivity\* of iron diminishes as its temperature is raised.*

This accords with the statement of Forbes, whose numbers for temperatures between 50° and 150° C. are probably very accurate.

2. *At temperatures above 150° C. the diminution of conductivity of iron is less rapid than that assigned by Forbes. The conductivity seems to reach a minimum somewhere about red-heat.*

3. *The thermal conductivity of copper and lead changes much less than that of iron with rise of temperature, and probably in the sense of increase instead of diminution. The same is true of German silver.*

4. *Electrically bad copper conducts heat worse than electrically good copper—but not in the same ratio.*

5. *The metals examined have the same order as conductors of heat and of electricity. The alloy violates this arrangement.*

\* [Had I been writing this paper afresh, instead of merely reprinting it, I should of course have used the term *Thermometric Conductivity* (after Maxwell) or *Thermal Diffusivity* (after Kelvin). But the whole context, specially the last paragraph of § 15, clearly defines what is meant. 1898.]

*Postscript.*—As I have not given the experimental data for the first part of this paper, I may state here the peculiarity upon which the above deductions chiefly depend.

The law of cooling is nearly the same (to a constant factor) for iron and the two kinds of copper throughout the range of temperatures employed.

But the statical curve for iron differs considerably from that for copper. The ratios of the temperature-excesses at intervals of three inches along the long bars increase at higher temperatures in iron much faster than in copper. In fact, the inferior copper almost realises Lambert's result.

#### ADDITION TO XLVIII.

[In July, 1887, I wrote the subjoined *Introduction* to a paper by Professor Crichton Mitchell on the "Thermal Conductivity of Iron, Copper, and German Silver," which appears in the *Trans. of the Royal Society of Edinburgh*, vol. XXXIII. It is given here because it briefly narrates how the work described in the preceding paper was subsequently followed up. 1898.]

Shortly after I read to the Society my paper on "Thermal and Electric Conductivity" [No. XLVIII. above], in which I stated that the results were "by no means final, even so far as my own work is concerned," I was requested by Sir Wyville Thomson to undertake the examination of the "Pressure Errors of the 'Challenger' Thermometers." This investigation led to another on the "Compression of Sea-Water," and allied subjects, which is not yet finished. Meanwhile, though I had prepared everything for my promised repetition of the experiments on Thermal Conductivity, the bars formerly used having been nickelised, &c., I found that it would be impossible for me to carry out the investigation. I therefore asked Mr Mitchell, who, as Neil-Arnott Scholar, had already done good and careful work on Thermal Conductivity in my Laboratory, to repeat the experiments under the altered conditions. I put at his disposal all the apparatus which was employed in the former research. The Government Grant Committee allowed a sum for the payment of a computer to reduce the results, and the observations were at once commenced. The results are now laid before the Society, and are probably as good as the method and the thermometers employed can furnish.

As regards the method, one grand defect is the uncertainty as to the relative amounts of surface loss of heat in the two parts of the experiment. The nickelising has, to a very great extent at least, removed the part of this uncertainty which was due to oxidation of the bars; but there remains another part, not at all easy to reckon and allow for, which depends on the fact that each thermometer in the long bar is maintained for hours in a nearly constant state of graduated temperature throughout its stem, while the corresponding state of that in the short bar not only varies rapidly as the cooling proceeds, but probably always materially differs from it. No attempt has been made to correct the results so far as this cause of error (which is probably of no great importance) is concerned. It is clear that its effect will be to make the

rate of cooling a little too small at the lower, as compared with the higher, temperatures.

Another defect, which indeed Forbes pointed out, is due to the very small temperature-gradients towards the colder end of the long bar. Mr Mitchell has carried out my suggestion of an artificial cooling of the middle of the bar, and it is highly interesting to compare together the results he has obtained with and without this cooling.

Ångström expressly stated (*Pogg. Ann.*, CXVIII. 1863) that no account need be taken of the change of specific heat with temperature. In my paper above referred to, I said that it appears that, in iron especially, this change produces a very considerable effect on the estimated values of the conductivity. In default of better data, Mr Mitchell has used those given (after Nichol and others) in a short paper in *Proc. R.S.E.* [Reprinted, as *Addition II.*, below. 1898.] The importance of this correction is shown by the comparison of the results obtained from it with those obtained when it is not applied. Mr Mitchell's experimental results are given in such a form that any subsequent improvement in these data can be taken advantage of without further experiment, and with very little trouble in the matter of calculation. The fact that the various short bars were exactly similar in surface in his experiments has enabled him to make a rough test of the accuracy of these data.

In the paper above referred to, [p. 390, below], I showed that the consideration of the rise of specific heat with temperature would destroy if not overcome the apparent fall of conductivity of iron at higher temperatures. But I had not then the means of properly applying the correction without repeating about one-half of the laborious calculations incident to Forbes' method. Mr Mitchell has in his calculations taken account of this consideration: and it must be regarded as one of the chief features of his paper that he has thus shown that iron does not form an exception to the law that ordinary metals *improve* in thermal conductivity as their temperature is raised.

As I am responsible for the methods employed by Mr Mitchell in the experiments and calculations, though not for the calculations themselves, I must state here the directions given and the grounds for them, at least in so far as they introduce processes differing (to any considerable extent) from those used by Forbes or by myself.

1. As to the empirical formula (B) for the statical curve, in the special case of the iron bar when there was no artificial cooling.

This I obtained by plotting the logarithms of the temperature-excesses as ordinates, the abscissæ being distances along the bar. The curve so obtained was nearly straight at the lower temperatures, and became rapidly more curved at higher temperatures. I therefore treated it as a branch of a hyperbola, and found its asymptote. Thus the *form* of the empirical expression was suggested at once.

2. The allowance for the unequal heating of the stems of the thermometers was obtained thus:—



Let  $v$  be the observed temperature (not the temperature-excess),  $w$  the true temperature, and in accordance with § 10 of my paper  $e = 10/250^2 = 0.00016$ . From the result of Mr Mitchell's comparison of the two thermometers, one partially, the other wholly, immersed in a paraffin bath, I have been confirmed in my assumption of an error of  $10^\circ$  at  $250^\circ$  C. Then we have

$$w = v + ev^2.$$

Thus, for the true temperature-gradient in the statical experiment,

$$\frac{dw}{dx} = (1 + 2ev) \frac{dv}{dx}.$$

Similarly, for the true rate of cooling, we have

$$\frac{dw}{dt} = (1 + 2ev) \frac{dv}{dt}.$$

The quantities on the right-hand sides are given by the experiments, or deduced directly by graphical methods or calculation.

For the statical curve of cooling it is easy to see in this way that each instalment of area must be multiplied by

$$1 + 2e \frac{v_1 + v_2}{2},$$

where  $v_1$  and  $v_2$  are the limiting temperatures of the instalment.

It is clear that this correction increases the gradient at any point of the bar in a greater ratio than that in which it increases the total area of the corresponding part of the curve which expresses the flux of heat; so that its effect must be to diminish the estimates of conductivity at higher, more than at lower, temperatures.

3. I was much surprised at the first results obtained by Mr Mitchell for the rates of cooling at high temperatures. At my instance he has repeated this part of the experiment in a form similar to that which I had employed, and certainly less likely to entail error, and the data thus obtained have been incorporated in the paper, in so far as they relate to the specified tables. [The remaining small difference between our results may be due to an overestimate in my 6 p. c. reduction for oxidation.]

4. There still remains a possible source of error, due to the thermometers themselves:—Kew Standards though they be. This arises from the way in which the  $200^\circ$  C. and  $300^\circ$  C. points were determined at Kew. The tubes having been carefully calibrated before filling, the standard points  $0^\circ$  C. and  $100^\circ$  C. were directly determined in the usual manner. But the positions of  $200^\circ$  C. and  $300^\circ$  C. were determined by taking successive portions of the tube whose volume (cold) corresponded to that of the portion (also cold) from  $0^\circ$  C. to  $100^\circ$  C. I have not the means of making allowance for this defect, which will probably mar all experiments of the kind until suitable air-thermometers are employed.

5. The fact that the values of conductivity deduced from experiments on the iron bar, when its full length is employed, differ so considerably from those obtained when it is artificially cooled in the middle, appears to be intimately connected with a remark made in my paper (§ 14) that "in measuring conductivity, at whatever temperature, things ought to be arranged so as to avoid any slow flux of heat." It seems that, even after the lapse of eight hours, the steady state of temperature has *not* been reached in the colder parts of the long iron bar.

6. As the numerical data, concerning specific gravity and specific heat, which Mr Mitchell has (in default of better) been obliged to employ, are only rough estimates, I asked him to test them by finding the ratios of the rates of cooling of copper and iron at various common temperatures. The surface material was the same in the two bars, and their dimensions equal, so that the *amount* of heat lost in a given (short) time must have been the same for each at the same temperature. The ratio of the rates of cooling should therefore be constant for all temperatures if, and only if, the rate of change of specific heat with temperature be the same for each of the two materials. The result does not seem to favour the accuracy of the assumed data, but the process employed is not by any means an accurate one.

7. As my determinations of the relative electric conductivities of the bars had been verified by Mr D'Arcy Thompson, there is no necessity for their repetition. But, using them, with Mr Mitchell's results for thermal conductivity, my comparative table [*ante*, p. 384], should be altered (subject, of course, to correction for improved values of specific gravity and specific heat) to something like the following:—

	Thermal.	Electric.
Copper (Crown) . . . . .	1·5	1·729
" (C.) . . . . .	1·0	1·000
Forbes' Iron . . . . .	0·23	0·264
Lead . . . . .	0·12	0·149
German Silver . . . . .	0·13	0·117

#### ADDITION II.

##### NOTE ON THERMAL CONDUCTIVITY, AND ON THE EFFECTS OF TEMPERATURE-CHANGES OF SPECIFIC HEAT AND CONDUCTIVITY ON THE PROPAGATION OF PLANE HEAT WAVES.

[*Proceedings of the Royal Society of Edinburgh, February 7, 1881.*]

IN the great majority, at least, of investigations (experimental or mathematical) connected with conduction of heat, it has been assumed that the known changes of specific heat of metals do not require to be taken into account. Thus Ångström says, even in his paper on the *Change of Conductivity with temperature* (*Pogg.* 118, 1863):—  
 "Da indess diese Veränderungen, soweit man sie kennt, wenigstens innerhalb der bei

den Beobachtungen vorkommenden Temperaturgränzen, nicht bedeutend sind,.....so müssen dieselben den Werth des Wärmecoefficienten nur unbedeutend afficiren können." In my paper on "Thermal and Electric Conductivity" [No. XLVIII. above, p. 380], I said that "the change of specific heat with temperature would *increase* the values of *k* at higher temperatures, and thus reduce the change in conductivity in iron, and increase the small changes indicated for the other substances." But I had not at hand the means of applying these corrections. Recent discussions as to the comparative merits of different experimental methods have led me to investigate the amount of this effect, by the aid of the best data I could procure. A comparison of these seems to leave no doubt that the specific heat of iron *increases* by somewhere about  $\frac{1}{700}$  of its amount for each degree of rise of temperature; at least from 0° to 300° C., between which limits the investigations of conductivity have hitherto been carried on.

Besides this result, which I have gathered from various scientific journals, I may adduce from my Laboratory Book for 1868 the following determinations: which were made with great care by the late Mr J. P. Nichol, by means of the method of mixtures. The nature of the process employed is such that the results *must* all err in defect, and the more so the higher the temperature. The iron was heated sometimes in oil, sometimes in paraffin.

*Specific Heat of Iron.*

		Mean.
15° to 100° C.	0·1154	} 0·1152
	0·1127	
	0·1158	
	0·1168	
15° to 150° C.	0·1193	} 0·1189
	0·1189	
	0·1186	
15° to 200° C.	0·1208	} 0·1213
	0·1214	
	0·1218	
15° to 250° C.	0·1234	} 0·1237
	0·1240	
15° to 300° C.	0·1274	} 0·1275
	0·1276	

From the first two of these means we find that the specific heat at 15° is 0·109 nearly, and that it increases by  $\frac{1}{730}$ th for each degree.

Now, Forbes' experiments on iron indicated that the quantity *k/c*, the ratio of the conductivity to the thermal capacity, *diminishes* by about  $\frac{1}{350}$ th part for each degree from 0° C. to 200° C. Hence it is clear that, in this case at least, the alteration of specific

heat cannot be neglected in estimating that of conductivity. For it follows from the numbers just given that the diminution per  $1^\circ$  in the conductivity of iron is really only about  $\frac{1}{2300}$ th of the whole amount. My own experiments with Forbes' bars gave an average change of  $k/c$  less than that due to the increase of  $c$  alone, thus indicating an increase of conductivity with rise of temperature. Ångström's result, on the other hand, is considerably greater than that of Forbes. But the range of temperatures he employed was not above forty degrees. For reasons pointed out in my paper above referred to, I consider Forbes' estimate of the value of  $k/c$ , from  $0^\circ$  to  $150^\circ\text{C}$ ., to be probably very near the truth. In other metals the change of specific heat is usually less than in iron. But so is also that of  $k/c$ . It would thus appear that we cannot yet state positively that there is any metal whose conductivity becomes less as its temperature rises; and thus the long-sought analogy between thermal and electric conductivity is not likely to be realised.

In the method devised and carried out by Forbes, the change of specific heat must be attended to during the calculations. Thus we cannot, without going over again the whole numerical work connected with what he called the *Statical Curve of Cooling*, estimate accurately what will be the effect of this element upon the values of the conductivity. But we can easily show that its influence upon Ångström's results is to be calculated, at least approximately, by the simple process above.

To avoid the error introduced by supposing rate of surface loss to be proportional to  $v$ , we take (instead of a bar) a plane slab heated and cooled periodically over one surface.

The equation for the consequent distribution of temperature is

$$c \frac{dv}{dt} = \frac{d}{dx} \left( k \frac{dv}{dx} \right).$$

If we assume

$$c = c_0 (1 + \alpha v),$$

$$k = k_0 (1 - \beta v),$$

where  $\alpha$  and  $\beta$  are small positive constants;

and put

$$\kappa = \frac{k_0}{c_0},$$

$$v = u + \omega,$$

where  $\omega$  depends upon first powers of  $\alpha$  and  $\beta$  only, higher powers being neglected; the equation splits into two as follows:—

$$\frac{du}{dt} = \kappa \frac{d^2u}{dx^2} \dots\dots\dots(1),$$

$$\frac{d\omega}{dt} - \kappa \frac{d^2\omega}{dx^2} = -\kappa(\alpha + \beta)u \frac{d^2u}{dx^2} - \kappa\beta \left( \frac{du}{dx} \right)^2 \dots\dots\dots(2).$$

For our present purpose it is sufficient to take

$$u = -Bx + C\epsilon^{-mx} \cos(2\kappa m^2 t - mx),$$

which satisfies (1), and shows the ultimate effect of a persistent simple harmonic application of heat to one side of the slab, whose temperature is taken as our temporary zero; the other side being kept at the temperature  $-Bs$ , where  $s$  is the thickness of the slab. Here  $s$  must be supposed so large that  $C\epsilon^{-ms}$  is insensible; else the value of  $u$  would be so complicated that (2) would become unmanageable.

Substituting the above value of  $u$  in (2), and integrating, we obtain the value of  $\omega$ . It consists of three parts.

We have, first, terms containing  $x$  only:—

$$\beta B^2 \frac{x^2}{2} + \frac{\beta}{4} C^2 \epsilon^{-2mx}.$$

These terms show how the mean temperature is altered throughout.

Next, we have the single term

$$\frac{\alpha + 2\beta}{4} C^2 \epsilon^{-2mx} \cos(4\kappa m^2 t - 2mx).$$

This is a small wave of half period, which we need not farther consider.

Finally we have, as the modification of the original wave,

$$C\epsilon^{-mx} \left\{ \left( \frac{\alpha - 3\beta}{4} Bx + \frac{m(\alpha + \beta)}{4} Bx^2 \right) \cos(2\kappa m^2 t - mx) - \frac{m(\alpha + \beta)}{4} Bx^2 \sin(2\kappa m^2 t - mx) \right\}.$$

These terms, when combined with the harmonic part of the assumed value of  $u$ , may be put in the form

$$C\epsilon^{-m_1 x} \cos(2\kappa m^2 t - m_2 x),$$

where

$$m_1 = m \left( 1 - \frac{\alpha - 3\beta}{4m} B - \frac{\alpha + \beta}{4} Bx \right),$$

$$m_2 = m \left( 1 - \frac{\alpha + \beta}{4} Bx \right).$$

We thus see the effects of the introduction of the quantities  $\alpha$  and  $\beta$  upon the amplitude and phase of the wave; and it is evident that they are of the greater consequence the greater is the difference of mean temperatures at the sides of the slab.

Hence the only legitimate mode of applying Ångström's method is to keep the mean temperature the same throughout the slab. This can easily be effected.

It is obvious, moreover, from the values of  $m_1$  and  $m_2$  above, that Ångström's method gives the value of  $k/c$  for the mean of the mean temperatures indicated by the

two thermometers. Only, there is always the extraneous factor

$$1 + \frac{\alpha - 3\beta}{4m} B$$

which is usually very nearly unity.

I have worked out by the above method the case of two harmonic waves (in the value of  $u$ ), one of half the period of the other. New terms are thus introduced into  $m_1$  and  $m_2$ . They are such as to seriously affect the values of these quantities when  $x$  is small, but they rapidly diminish by increase of  $x$ .

If the new term in  $u$  be

$$D\epsilon^{-mx\sqrt{2}} \cos(4\kappa m^2 t - mx\sqrt{2} + E),$$

the additional terms in  $m_1$  are

$$-\frac{\alpha + \beta}{4m} D\epsilon^{-mx\sqrt{2}} \sin X - \frac{\beta}{2\sqrt{2} - 1} \frac{D}{m} \epsilon^{-mx\sqrt{2}} \cos X.$$

Those in  $m_2$  are formed from these by making the first term positive, and interchanging the sine and cosine of

$$X = mx(\sqrt{2} + 1) - E.$$

It appears from this investigation that Ångström's method, when applied with proper precautions, is theoretically capable of giving very good results. But it is probable that, in practice, the thermometers will have to be supplanted by thermoelectric junctions and a good dead-beat galvanometer. The best thermometers, when employed for rapidly varying temperatures, work by sudden starts.

## XLIX.

## NOTE ON ELECTROLYTIC CONDUCTION.

[*Proceedings of the Royal Society of Edinburgh, April 15, 1878.*]

It is commonly said that there is a resistance to a current at the surface of contact of a solid conductor and an electrolyte. Some good authorities, however, say that we have as yet no proof of this, as the effects observed may be due to polarisation alone. It is obvious that, if the reverse electromotive force due to polarisation contain a term directly proportional to the strength of the current, the ordinary methods of measurement would not enable us to distinguish this from the surface resistance above mentioned. For, in the expression

$$I = \frac{\Sigma(E)}{\Sigma(R)},$$

if the numerator contain a term of the form  $-eI$ , it may be expunged, provided  $e$  be added to the denominator.

To clear up this point I have recently made a number of experiments. These have led me to some curious results bearing on the theory of electrolysis, which I propose to bring before the Society on a future occasion. At present I refer to them merely so far as to say that they seem to establish the existence of the surface resistance above mentioned. But I was led to see that if a slip of platinum be inserted between the electrodes of a decomposing cell it ought, except in extreme cases, to produce almost precisely the same result as a similar and equal slip of glass or mica. This was easily verified. Here we have the singular result of a marked diminution of the current by the insertion into the electrolyte of a substance which is in itself a much superior conductor. Even when the platinum completely closes the path from one electrode to the other, so as to form two decomposing cells instead of one, a comparatively small hole made in it at once modifies its function from that of common electrode to each of two decomposing cells towards that of a mere *obstruction* in one cell. It is an interesting experimental inquiry to trace the intermediate stages between these two states, as a pinhole in the platinum is gradually enlarged. Whatever, then, be the behaviour of the particles of an electrolyte, they do *not* behave like little pieces of platinum. [This question is treated in a later paper. 1898.]

## L.

## NOTE ON A MODE OF PRODUCING SOUNDS OF VERY GREAT INTENSITY.

[*Proceedings of the Royal Society of Edinburgh, July 1, 1878.*]

Two years ago I had an opportunity of making from the deck of the steamer "Pharos" some observations on the performance of the fog-siren at Sanda, off the Mull of Cantire. The instrument is worked by air at about  $1\frac{1}{4}$  atmospheres pressure; and, though driven by a powerful air-engine, sounds for 7 seconds only per minute. One obvious defect of such an arrangement I saw to be the waste of energy in producing a current of air through the trumpet of the siren along with the oscillations. It then occurred to me that a regular alternation of puffing and sucking—exactly analogous to the air-disturbance produced by a drum—must be a much less costly source of sound. I have since constructed a siren on this double action principle, the air in the trumpet, which acts as a resonator, being put alternately in connection with reservoirs of compressed and rarefied air. The small model has given very good results, and a larger one is in progress. The only defect which my model showed was a waste of energy in the form of pulsations in the tubes leading to the exhausted receiver and to that containing compressed air. This can be very greatly reduced, but I do not yet see how to get rid of it entirely, unless it be possible to make both receivers so exactly as to act as additional resonators to the siren. If this can be carried out in practice there will be no energy spent except in sound. It is obvious that the principle just described is approximated to in practice whenever steam is employed in a siren:—the vacuum being produced by the condensation of the steam.

Another device of a somewhat different character was suggested to me by the



experiments described in the preceding paper\*. After trying, without much success, to reduce the intensity of the siren notes by filing the edges of the apertures, it occurred to me that I might usefully *intensify* them. I therefore had copper plates soldered perpendicularly to the revolving disc, so as to increase instead of diminishing the virtual thickness of the edges of the apertures. The result was very striking. Such a siren gives a sound whose intensity is not sensibly increased by a powerful blast from an organ bellows. It produces strong currents of air through the holes in the fixed disc, whose direction in general depends upon the direction in which the rotating disc is made to revolve; and especially does so when the copper plates are inclined to the surface of that disc. When the discs are both furnished with these plates, turned in opposite directions, the result is still more striking. Various other modifications have occurred to me, and are now under trial, especially one for producing currents alternately in opposite directions through the holes.

By bringing up a flat plate towards the instrument, the quality of the sound is altered in a remarkable manner, and to such an extent that it seems well adapted for rapid Morse-signalling. As this instrument requires no work to be spent except in turning it, a very large number may be kept continuously at work at once by the same expenditure of power as is required for the intermittent roaring of a single fog-siren.

\* ["On certain Effects of Periodic Variation of Intensity of a Musical Note. By Professors Crum Brown and Tait." The sound was admitted through apertures pierced in a fixed plate and in another which rotated in close contiguity to it; and the experiments were interfered with, when considerable angular speed was given to the latter, by its direct action as a sort of siren. 1898.]

## LI.

## OBITUARY NOTICE OF JAMES CLERK-MAXWELL.

[*Proceedings of the Royal Society of Edinburgh, December 1, 1879.*]

WHEN I first made Clerk-Maxwell's acquaintance about thirty-five years ago, at the Edinburgh Academy, he was a year before me, being in the fifth class while I was in the fourth.

At school he was at first regarded as shy and rather dull; he made no friendships, and he spent his occasional holidays in reading old ballads, drawing curious diagrams, and making rude mechanical models. His absorption in such pursuits, totally unintelligible to his schoolfellows (who were then quite innocent of mathematics), of course procured him a not very complimentary nickname, which I know is still remembered by many Fellows of this Society. About the middle of his school career, however, he surprised his companions by suddenly becoming one of the most brilliant among them, gaining high, and sometimes the highest, prizes for Scholarship, Mathematics, and English verse composition. From this time forward I became very intimate with him, and we discussed together, with school-boy enthusiasm, numerous curious problems, among which I remember particularly the various plane sections of a ring or *tore*, and the form of a cylindrical mirror which should show one his own image *unperverted*. I still possess some of the MSS. which we exchanged in 1846 and early in 1847. Those by Maxwell are on "The Conical Pendulum," "Descartes' Ovals," "Meloid and Apoid," and "Trifocal Curves." All are drawn up in strict geometrical form and divided into consecutive propositions. The three latter are connected with his first published paper, communicated by Forbes to this Society and printed in our *Proceedings*, vol. II., under the title "On the Description of Oval Curves, and those having a plurality of foci" (1846).

At the time when these papers were written he had received no instruction in Mathematics beyond a few books of Euclid, and the merest elements of Algebra.

The winter of 1847 found us together in the classes of Forbes and Kelland, where he highly distinguished himself. With the former he was a particular favourite, being admitted to the free use of the class apparatus for original experiments. He lingered here behind most of his former associates, having spent three years at the University of Edinburgh, working (without any assistance or supervision) with physical and chemical apparatus, and devouring all sorts of scientific works in the library\*. During this period he wrote two valuable papers, which are published in our *Transactions*, on "The Theory of Rolling Curves," and "On the Equilibrium of Elastic Solids." Thus he brought to Cambridge in the autumn of 1850 a mass of knowledge which was really immense for so young a man, but in a state of disorder appalling to his methodical private tutor. Though that tutor was William Hopkins, the pupil to a great extent took his own way; and it may safely be said that no high wrangler of recent years ever entered the Senate-House more imperfectly trained to produce "paying" work than did Clerk-Maxwell. But by sheer strength of intellect, though with the very minimum of knowledge how to use it to advantage under the conditions of the examination, he obtained the position of Second Wrangler, and was bracketed equal with the Senior Wrangler in the higher ordeal of the Smith's Prizes. His name appears in the Cambridge "Calendar" as Maxwell of Trinity, but he was originally entered at Peterhouse, and kept his first term there, in that small but most ancient foundation which has of late furnished Scotland with the majority of the Professors of Mathematics and Natural Philosophy in her four Universities.

In 1856 he became Professor of Natural Philosophy in Marischal College, Aberdeen; in 1860, Professor of Physics and Astronomy in King's College, London. He was successively Scholar and Fellow of Trinity; and was elected an Honorary Fellow of Trinity when he finally became, in 1871, Professor of Experimental Physics in the University of Cambridge. There can be no doubt that the post to which he was ultimately called was one for which he was in every way pre-eminently qualified; and the Cavendish Laboratory, erected and furnished under his supervision, remains as remarkable a monument to his wide-ranging practical knowledge and theoretical skill as it is to the well-directed munificence of its noble founder.

If the title of mathematician be restricted (as it too commonly is) to those who possess peculiarly ready mastery over symbols, whether they try to understand the significance of each step or no, Maxwell was not, and certainly never attempted to be, in the foremost rank of mathematicians. He was slow in "writing out," and avoided as far as he could the intricacies of analysis. He preferred always to have before him a geometrical or physical representation of the problem in which he was engaged, and to take all his steps with the aid of this: afterwards, when necessary,

\* From the University Library lists for this period it appears that Maxwell perused at home Fourier's *Théorie de la Chaleur*, Monge's *Géométrie Descriptive*, Newton's *Optics*, Willis's *Principles of Mechanism*, Cauchy's *Calcul Différentiel*, Taylor's *Scientific Memoirs*, and many other works of a high order. Unfortunately no record is kept of books consulted in the reading-room.

translating them into symbols. In the comparative paucity of symbols in many of his great papers, and in the way in which, when wanted, they seem to grow full-blown from pages of ordinary text, his writings resemble much those of Sir William Thomson, which in early life he had with great wisdom chosen as a model.

There can be no doubt that in this habit, of constructing a mental representation of every problem, lay one of the chief secrets of his wonderful success as an investigator. To this were added an extraordinary power of penetration, and an altogether unusual amount of patient determination. The clearness of his mental vision was quite on a par with that of Faraday; and in this (the true) sense of the word he was a mathematician of the highest order.

But the rapidity of his thinking, which he could not control, was such as to destroy, except for the very highest class of students, the value of his lectures. His books and his written addresses (always gone over twice in MS.) are models of clear and precise exposition; but his *extempore* lectures exhibited, in a manner most aggravating to the listener, the extraordinary fertility of his imagination.

During his undergraduateship in Cambridge he developed the germs of his future great work on "Electricity and Magnetism" (1873) in the form of a paper "On Faraday's Lines of Force," which was ultimately printed in 1856 in the *Trans. of the Cambridge Philosophical Society*. He showed me the MS. of the greater part of it in 1853. It is a paper of great interest in itself, but extremely important as indicating the first steps to such a splendid result. His idea of a fluid, incompressible and without mass, but subject to a species of friction in space, was confessedly adopted from the analogy pointed out by Thomson in 1843 between the steady flow of heat and the phenomena of statical electricity.

In recent years he came to the conclusion that all such analogies, depending as they do on Laplace's equation, were best symbolised by the quaternion notation with Hamilton's  $\nabla$  operator; and in consequence, in his work on electricity, he gives the expressions for all the more important physical quantities in their quaternion form, though without employing the calculus itself in their establishment. I have discussed in another place (*Nature*, vol. VII. p. 478) the various important discoveries in this remarkable work, which of itself is sufficient to secure for its author a foremost place among natural philosophers. I may here state that the main object of the work is to do away with "action at a distance," so far at least as electrical and magnetic forces are concerned, and to explain these by means of stresses and motions of the medium which is required to account for the phenomena of light. Maxwell has shown that, on this hypothesis, the speed of light is the ratio of the electro-magnetic and electro-static units. Since this ratio, and the actual speed of light, can be determined by absolutely independent experiments, the theory can be put at once to an exceedingly severe preliminary test. Neither quantity is yet fairly known within about 2 or 3 per cent., and the most probable values of both certainly agree more closely than do the separate determinations of either. There can now be little doubt that Maxwell's theory of electrical phenomena rests upon foundations as secure

as those of the undulatory theory of light. But the life-long work of its creator has left it still in its infancy, and it will probably require for its proper development the services of whole generations of mathematicians.

The next in point of date of Maxwell's greatest works is his "Essay on the Stability of Saturn's Rings," which obtained the Adams' Prize in 1859. In this admirable investigation he shows that it is dynamically impossible that these rings can be either solids or continuous liquid masses; the only other available hypothesis, viz., that they consist of a multitude of discrete parts, each a satellite, must therefore be the correct one.

Another question which he treated with great success, as well from the experimental as from the theoretical point of view, was the Perception of Colour, the Primary Colour sensations, and the Nature of Colour Blindness. His earliest paper on these subjects bears date 1855, and the seventh has the date 1872. He received the Rumford Medal from the Royal Society in 1860, "For his Researches on the Composition of Colours, and other optical papers." Though a triplicity about colour had long been known or suspected, which Young had (most probably correctly) attributed to the existence of three sensations, and Brewster had erroneously\* supposed to be objective, Maxwell was the first to make colour-sensation the subject of actual measurement. He proved experimentally that any colour  $C$  (given in intensity of illumination as well as in character) may be expressed in terms of three arbitrarily chosen standard colours,  $X$ ,  $Y$ ,  $Z$ , by the formula

$$C = aX + bY + cZ.$$

Here  $a$ ,  $b$ ,  $c$  are numerical coefficients, which may be positive or negative; the sign = means "matches," + means "superposed," and - directs the term to be taken to the other side of the equation.

The last of his greatest investigations bore on the Kinetic Theory of Gases. Originating with [Hooke and] D. Bernoulli, this theory was advanced by the successive labours of Herapath, Joule, and particularly of Clausius, to such an extent as to put its general accuracy beyond a doubt. But by far the greatest developments it has received are due to Maxwell, part of whose mathematical work has recently been still further extended in some directions by Boltzmann. In this field Maxwell appears as an experimenter (on the laws of gaseous friction) as well as a mathematician. His two latest papers deal with this branch of physics; one is an extension and simplification of some of Boltzmann's chief results, the other treats of the kinetic theory as applied to the motion of the radiometer.

He has written an admirable text-book of the "Theory of Heat," which has already gone through several editions, and a very excellent elementary treatise on "Matter and Motion." (See, again, *Nature*, vol. XVI. p. 119.) Even this, like his other and larger works, is full of valuable matter, worthy of the most attentive perusal not of students alone but of the very foremost scientific men.

\* All we can positively say to be erroneous is some of the principal arguments by which Brewster's view was maintained, for the subjective character of the triplicity has not been absolutely *demonstrated*.

Of his other scientific work, which extended over the whole range of physics, I may specially mention the following papers:—

On the transformation of surfaces by bending, *Camb. Phil. Trans.*, 1854.

The discovery of the production of double refraction in viscous liquids (*Proc. R.S.*, 1873), a late consequence of some of the results of his early paper of 1850.

A general theory of optical instruments, *Quart. Journ. of Math.*, 1858.

On reciprocal figures, frames, and diagrams of forces, *Trans. R.S.E.*, 1872. For this paper he obtained the Keith Prize.

His share in the construction of the British Association units of electric resistance, and in the admirable reports of the Committee. Also his experimental verification of Ohm's law.

For further particulars recourse must be had to the Royal Society's Catalogue of Scientific Papers.

To these may now be added his numerous contributions to the latest edition of the *Encyclopædia Britannica*—Atom, Attraction, Capillarity, &c.; and the laborious task of preparing for the press, with copious and very valuable original notes, the *Electrical Researches of the Hon. Henry Cavendish*. This work has appeared only within a month or two, and contains many singular and most unexpected revelations as to the early progress of the science of electricity.

The works which we have mentioned would of themselves indicate extraordinary activity on the part of their author, but they form only a fragment of what he has published; and when we add to this the further statement, that Maxwell was always ready to assist those who sought advice or instruction from him, and that he has read over the proof-sheets of many works by his more intimate friends (enriching them by notes, always valuable and often of the quaintest character), we may well wonder how he found time to do so much.

Maxwell's early skill in versification developed itself in later years into real poetic talent. But it always had an object, and often veiled the keenest satire under an air of charming innocence and *naïve* admiration. No living man has shown a greater power of condensing the whole substance of a question into a few clear and compact sentences than Maxwell exhibits in his verses. As an exceedingly good example of his style we may quote the lines written for the portrait of Cayley, now in Trinity College, Cambridge.

“O wretched race of men, to space confined!  
 What honour shall ye pay to him whose mind  
 To that which lies beyond hath penetrated?  
 The symbols he hath formed shall sound his praise,  
 And lead him on through unimagined ways  
 To conquests new in worlds not yet created.

“First ye determinants, in ordered row  
 And massive column ranged, before him go,  
 To form a phalanx for his safe protection.  
 Ye powers of the  $n$ th roots of  $-1$ ,  
 Around his head in endless cycles run,  
 As disembodied spirits of direction.

“And you ye undevelopable scrolls,  
 Above the host wave your emblazoned rolls,  
 Ruled for the record of his bright inventions.  
 Ye cubic surfaces, by threes and nines,  
 Draw round his camp your seven-and-twenty lines,  
 The seal of Solomon in three dimensions.

“March on, symbolic host, with step sublime,  
 Up to the flaming bounds of space and time ;  
 There halt, until, by Dickenson depicted  
 In two dimensions, we the form may trace  
 Of him whose mind, too large for vulgar space,  
 In  $n$  dimensions flourished unrestricted.”

Other exquisite specimens are given in *Nature*: especially good is his “Lecture to a Lady on Thomson’s Reflecting Galvanometer.” One of the few others which have been printed was secured by John Blackwood for his Magazine, where it appeared under the title “British Association, 1874,” in November of that year.

It is to be hoped that these scattered gems may be collected and published, for they are of the very highest interest, as the work during leisure hours of one of the most piercing intellects of modern times. Every one of them contains evidence of close and accurate thought, and many are in the happiest form of epigram.

I cannot adequately express in words the extent of the loss which his early death has inflicted not merely on his personal friends, on this Society, on the University of Cambridge, on the whole scientific world, but also, and most especially, on the cause of common sense, of true science, and of religion itself, in these days of much vain-babbling, pseudo-science, and materialism. But men of his stamp never live in vain; and in one sense at least they cannot die. The spirit of Clerk-Maxwell still lives with us in his imperishable writings, and will speak to the next generation by the lips of those who have caught inspiration from his teachings and example.

Scotland may well be proud of the galaxy of grand scientific men whom she numbers among her own recently lost ones; yet even in a company which includes Brewster, Forbes, Graham, Rowan Hamilton, Rankine, and Archibald Smith, she will assign a place in the very front rank to James Clerk-Maxwell.

[This sketch appeared again, with considerable changes, mainly in the way of further development, in *Nature*, Vol. XXI. 1898.]

## LII.

## MATHEMATICAL NOTES.

[*Proceedings of the Royal Society of Edinburgh, January 5, 1880.*]

## (a) ON A PROBLEM IN ARRANGEMENTS.

WHILE making some algebraic problems last summer for an examination, I devised the following question:—

“A schoolmaster went mad, and amused himself by arranging the boys. He turned the dux boy down one place, the new dux two places, the next three, and so on till every boy's place had been altered at least once. Then he began again, and so on; till, after 306 turnings down, all the boys got back to their original places. This disgusted him, and he kicked one boy out. Then he was amazed to find that he had to operate 1120 times before all got back to their original places. How many boys were in the class?”

It is clear that one of the factors of the number of turnings down is  $(n-1)$ , where  $n$  is the number of boys in the class. The factors of 306 are 18 and 17, and those of 1120 are 7, 10, and 16. If we try 17 as the original value of  $n-1$ , 16 will be the value for one boy less: from which it appears by a tentative process that the class consisted of 18 boys. But it is interesting to examine the nature of the question more closely. It is intimately connected with one of the problems suggested in my paper on “Knots” (No. XXXIX. above, § 5, pp. 278 sq.). If we know the arrangement of the boys—after one of them has for the first time been turned to the foot of the class,—the processes given in that paper lead easily to the complete solution.

Now it is easy to see that the particular arrangement just mentioned can be found diagrammatically as follows:—



Write down the numbers  $1\ 2\ 1$ .

Put the double of the middle number to the right of it, and the next lower number to the left. Thus

$$1\ 3\ 2\ 4\ 1.$$

Operate in the same way on the numbers *last introduced*, and we have

$$1\ 5\ 3\ 6\ 2\ 7\ 4\ 8\ 1.$$

Continue in this way, and arrange these groups in successive order, leaving out the final 1 from each. We thus have the series

$$1, 2, 1, 3, 2, 4, 1, 5, 3, 6, 2, 7, 4, 8, 1, 9, 5, 10, 3, 11, 6, 12, 2, 13, 7, \&c.$$

Strike off the first  $n - 1$  of these numbers ( $n$  being the number of boys), and the next  $n$  represent the arrangement of the class after all have been displaced: the numbers designating the several boys by their original places. Hence we have the key for translating the series into the successive derangements.

Another curious mode of getting this series is to begin with 1, then prefix 1, and insert 2, as below:—

$$1\ 2\ 1.$$

Again prefix 1, and insert 2, 3, 4, then

$$1\ 2\ 1\ 3\ 2\ 4\ 1,$$

and so on indefinitely.

It is worthy of remark that this series gives the integral of the equation

$$u_{2x+1} = u_x;$$

with the conditions

$$u_{2x} = x + 1,$$

$$u_1 = 1;$$

*i.e.*, the solution of the following question:—

“Arrange an infinite row of numbers, those in the even places being 2, 3, 4, &c., so that if the first  $(n - 1)$  be struck off ( $n$  being any integer) the next  $n$  may consist of all the natural numbers from 1 to  $n$  inclusive.”

Another result which these numbers present is the following:—Every positive integer can be expressed, in one way only, by the sum of a finite number of terms of one of the infinite set of series

$$1 + 2 + 4 + 8 + 16 +$$

$$2 + 3 + 6 + 12 + 24 +$$

$$4 + 5 + 10 + 20 + 40 +$$

$$6 + 7 + 14 + 28 + 56 +$$

$$8 + 9 + 18 + 36 + 72 +$$

&c., &c.,

the partial sums for each being the several places occupied in the above series by each particular integer. This, however, is obvious when we consider that the sum of  $(n+1)$  terms of any one of these series is of the form

$$(2r+1)2^n - 1,$$

and that this expression can be made to equal any given positive integer by one definite pair (and one only) of values of  $r$  and  $n$ .

Thus we see that we may write

$$u_x = \frac{1}{2} (1 + \overline{x+1}),$$

where the bar under  $x+1$  means that it is to be divided by the highest power of 2 that it contains.

The numbers of operations, for classes of different numbers of boys from 2 to 25 inclusive, are in order as follows:—

$$2, 4, 9, 20, 30, 36, 28, 72, 36, 280, 110, 108, 182, 168, 75, 1120, 306, \\ 432, 190, 140, 4410, 2772, 2530, 1440.$$

The calculation of the numerical value of any particular term is easy, but I have not attempted to express the general law of this very curious series. It seems, however, to be well worthy of attention, especially from the point of view of the expressions for numbers in the binary scale.

#### (b) ON A GRAPHICAL SOLUTION OF THE EQUATION $V\rho\phi\rho=0$ .

This equation has been exhaustively treated in our *Transactions* by M. G. Plarr. The present note is a mere sketch of a graphical solution. Let  $\phi$  be divided into parts, one self-conjugate, the other not, then

$$\phi = \overline{\omega} + V.\epsilon,$$

and the given equation may be written

$$\overline{\omega}\rho + V\epsilon\rho = x\rho.$$

Hence

$$S.\rho\{(\overline{\omega}-x)\alpha + V\alpha\epsilon\} = 0$$

whatever be  $\alpha$ . Let  $\alpha, \beta, \gamma$  be the principal unit-vectors of the pure strain  $\overline{\omega}$ , and  $a, b, c$  (in descending order of magnitude) the associated scalars. Then the equation for  $x$  is, at once,

$$S.\{(a-x)\alpha + V\alpha\epsilon\}\{(b-x)\beta + V\beta\epsilon\}\{(c-x)\gamma + V\gamma\epsilon\} = 0.$$

This may be written as

$$(x-a)(x-b)(x-c) - \epsilon^2(x+S.U\epsilon\overline{\omega}U\epsilon) = 0.$$

Thus the problem is reduced to finding the limiting value of  $T\epsilon$ , for any given value of  $U\epsilon$ , so that the above equation may have all its roots real. This leads by the ordinary methods to a cubic in  $T\epsilon^2$ , but the expression is rather complicated.

For variety let us adopt a graphic method. It is obvious that the extreme values of  $-S.U\epsilon\bar{\omega}U\epsilon$  are  $a$  and  $c$ .

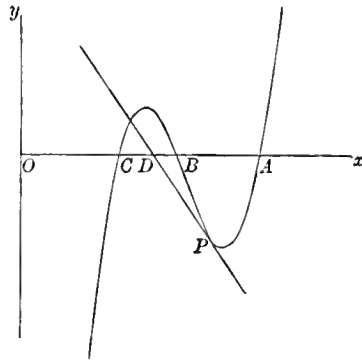

Let the curve represent the equation

$$y = (x - a)(x - b)(x - c),$$

and let  $OD$  represent any assumed value of  $-S.U\epsilon\bar{\omega}U\epsilon$ .  $D$  must lie on the finite line  $AC$ . From  $D$  draw, as in the figure, a tangent  $DP$  to the curve; and suppose a simple shear to be applied to the figure, parallel to the axis of  $y$ , so as to make this tangent coincide with the axis of  $x$ . The equation of the curve after the shear will obviously be

$$y = (x - a)(x - b)(x - c) + \tan \widehat{PDA} (x - OD)$$

and it will touch the axis of  $x$ . Comparing this with the equation above, we see that we have for the maximum value required

$$T\epsilon^2 = \tan \widehat{PDA}.$$

The absolute maximum of  $T\epsilon$  is obviously when the point of contact is the point of inflexion of the curve (whose abscissa is  $\frac{1}{3}(a + b + c)$ ), and the least values when  $D$  coincides with  $C$  or with  $A$ . These values are easily seen to be, in order,

$$\frac{a - c}{2} \sqrt{1 + \frac{1}{3} \left( \frac{a - 2b + c}{a - c} \right)^2}, \quad \frac{a - b}{2}, \quad \text{and} \quad \frac{b - c}{2}.$$

## LIII.

## NOTE ON THE THEORY OF THE "15 PUZZLE."

[*Proceedings of the Royal Society of Edinburgh, June 7, 1880.*]

[AFTER this note had been laid before the Council, the new number (vol. II. No. 4) of the *American Journal of Mathematics* reached us. In it there are exhaustive papers by Messrs Johnston and Story on the subject of this American invention. The principles they give differ only in form of statement from those at which I had independently arrived. I have, therefore, cut down my paper to the smallest dimensions consistent with intelligibility.—P. G. T.]

The essential feature of this puzzle is that the circulation of the pieces is necessarily in rectangular channels. Whether these form four-sided figures, or have any greater (*even*) number of sides, the number of squares in the channel itself is always even. (This is the same thing as saying that a rook's re-entrant path always contains an even number of squares. This follows immediately from the fact that a rook always passes through black and white squares alternately. The same thing is true of a bishop's re-entering path, for it is a rook's upon a new chess-board formed by the alternate diagonals of the squares on the original board.) That there may be circulation in the channel, one of its squares must be the blank one.

Hence an *odd* number of pieces lies along the channel, and, therefore, when they are anyhow displaced along it, so that the blank square finally remains unchanged, the number of interchanges is essentially *even*.

Thus to test whether any given arrangement can be solved, all we need know is how many interchanges of two pieces will reduce it to the normal one. If this number be even, the solution is possible. To find the number of interchanges, we have only to write in pairs the numbers occupying the same square in each

arrangement, and divide them into groups, such as  $\begin{matrix} a & b & c & d \\ b & c & d & a \end{matrix}$ , which form closed cycles. Here there are *four* pairs in the group, which correspond to *three* interchanges, because  $\begin{matrix} a & b \\ b & a \end{matrix}$  is one interchange.

Dr Crum Brown suggests the term *Aryan* for the normal arrangement, with the corresponding term *Semitic* for its perversion. Similarly *Chinese* would signify the Aryan rotated right-handedly through a quadrant, and *Mongol* Semitic rotated left-handedly through a quadrant.

Now it is easily seen that Aryan is changed into Semitic, and Chinese into Mongol, or *vice versa*, by an odd number of interchanges. Similarly Aryan and Mongol, and Semitic and Chinese, differ by an even number of interchanges.

Hence any given arrangement must be either Aryan or Semitic. The former can be changed into Mongol, the latter into Chinese.

Unless the 6 and 9 be carefully distinguished from one another every case is solvable, for if it be Semitic the mere turning these figures upside down effects one interchange and makes it Aryan.

The principle above stated is, of course, easily applicable to the conceivable, but scarcely realisable, case of a rectangular arrangement of equal cubes with one vacant space.

## LIV.

## NOTE ON A THEOREM IN GEOMETRY OF POSITION.

[*Transactions of the Royal Society of Edinburgh*. Read July 19; revised November 13, 1880.]

IN connection with the problem of Map-colouring, I incidentally gave (*Proc. R.S.E.* 1880, pp. 502, 729) a theorem which may be stated as follows:—

*If  $2n$  points be joined by  $3n$  lines, so that three lines, and three only, meet at each point, these lines can be divided (usually in many different ways) into three groups of  $n$  each, such that one of each group ends at each of the points.*

Fig. 1, Plate X., shows such an arrangement (drawn at random) with *one* mode of grouping the lines, indicated by the marks O, I, II.

The difficulty of obtaining a simple proof of this theorem originates in the fact that it is not true without limitation. For it fails when an odd number of the points forms a group connected by a *single* line only with the rest, as in fig. 2; and, though we may enunciate the theorem in a form in which it is universally true so far as the literal interpretation of the words is concerned, we do not, so far as I can see, thereby facilitate the proof: while we deprive the theorem of its full generality. For the projection of a polyhedron cannot have a group of points joined to the rest by *two* lines only; and yet the theorem is true for such a diagram. The altered form is as follows:—

*The edges of any polyhedron, which has trihedral summits only, can be divided into three groups, one from each group ending in each summit.*

But a diagram such as fig. 3, for which the proposition is obviously true, is excluded from this enunciation, unless we agree to apply the term polyhedron to solids such as (for instance) an ordinary cylindrical lens with two edges and flat ends.

Hamilton's *Icosian Game* is a particular application of this theorem, the corresponding figure being a projection of a pentagonal dodecahedron. It was suggested to him by the remark, in Mr Kirkman's paper on Polyhedra (*Phil. Trans.* 1858, p. 160), that a clear "circle of edges" of a unique type passed through all the summits of this polyhedron.

In this note I sketch, each very briefly, a number of different ways of considering the question.

1. The simplest mode is to join, two and two, in any way whatever, the points of the system, by lines additional to those already drawn, neglecting any new intersections which may thus arise. The figure has then an even number of points, with four lines drawn to each; and can therefore be regarded as formed of superposed (not self-cutting) closed circuits, each of which cuts another in an even number of points. The new lines must be so grouped that in the circuits which contain them they *alternate* with lines originally in the figure. It will be seen in § 2 that this proves the theorem at once by the help of those circuits which contain none of the new lines. But the application of this method to particular cases is by no means easy; for we may have to try several combinations before we obtain a solution of the kind desired.

2. Assuming, for a moment, the truth of the proposition as given in the first statement, it is obvious that the lines of any two of the groups together form a *closed* polygon or polygons, each of an *even* number of sides: and, conversely, when (as just shown) we have such circuits, the proposition is true. (The italicised words show at once the reason for the exception to the theorem. For if the single joining line be part of a polygon, *that* cannot be a closed one; and, if it be not part of a polygon, there must be at least two polygons with an odd number of sides each.) When there are more polygons than one, the letterings of the alternate sides of one of them may be interchanged; and we thus get, by combining these separately with the third set of  $n$  lines, a couple of new solutions. If either of these consist of more polygons than one, this process may be again applied, and thus we have two more solutions. Hence it is always possible to obtain a solution in which two assigned sides of one compartment of the diagram shall form parts of the same even-sided polygon. (From this consideration, as appears in § 5, we have another direct proof of the theorem.) Hence, also, it would appear that, as this breaking into different sets of polygons cannot go on indefinitely, there must always be at least one solution which consists of a single polygon: provided, at least, that we keep to projections of polyhedra, for the statement is obviously not true of diagrams like fig. 3. But on this point I am not yet certain; and I pass it by for the present, as it is not of importance to the proposition, though it would be of great consequence to the making a perfectly general puzzle on the plan of the icosian game.

3. A glance at the groups of connected figures of Plate X. (in which the polygon or polygons are bounded by double lines), will show better than any words of description the nature of the processes which I have just indicated.

Fig. 7 has a very large number of solutions, twelve only of which are drawn.

„ 8 is merely fig. 1 a little distorted. The additional line, which distinguishes it from fig. 7, makes it essentially unsymmetrical.

„ 9 is essentially the same diagram as that of the *Icosian Game*.

„ 10 is merely fig. 3; with one additional line, causing one at least of the two-sided compartments to be joined to the rest by three lines. This at once makes the solution with a single polygon possible.

*N.B.*—When a figure is symmetrical about any axis, the perversion of any solution is also a solution.

4. Or thus: when a set of points are joined so that two, and only two, joining lines meet at each point, these lines must obviously form one or more closed polygons. Hence, in the case before us, by limiting the selection to two out of the three lines drawn to each point, we can always, in many different ways, form a polygon or polygons. If the number of sides in each of these is even, the main proposition is at once proved; for the alternate sides of the polygons belong to two of the three groups—the unused lines forming the third group. Such solutions must evidently be possible in all cases, with the exception of that already excluded. This knowledge, however, does not at once help us to a *practical* solution of the problem in any particular case. We must, therefore, look at the result more generally.

If the selection we have made gives more than one polygon, two or other even number of them may have an odd number of sides each. Suppose there are but two. If these be connected by *one* line only, we have the excepted case above. If they be connected by three, or a larger *odd* number of lines, we may always proceed as is indicated in figs. 6. *6a* shows the two odd-sided polygons. *6b* and *6c* show how, neglecting the points *C* and *C'*, we form even-sided polygons passing through them and including *AB* and *A'B'* respectively. Finally, *6d* shows the result when the two latter figures are joined. Thus the proposition is proved by actually effecting the decomposition into polygons of an even number of sides. Hence it is true for any even number of points (the excepted case excluded) if it is true for smaller even numbers of points. But it is obviously true for two, for four, and for six, points.

5. Another mode of reaching the same conclusion, is to pass from a case of  $2n$  points to one of  $2n + 2$  by drawing a new line terminating in any two sides of one of the even-sided polygons of the former case (§ 2). That polygon remains even-sided, but its sides must be relettered; and then we have one or more solutions of the new case.

In fact, by temporarily suppressing, two by two, points and their joining line (always taking care that the figure left shall not belong to the excepted case) we can reduce any case, however complex, to the four points for which the proposition is always true. [Or we may suppress one line, and divide the figure into two odd-sided polygons passing respectively through its ends. On restoring the line, these two polygons give a solution.]

6. Practically, in every case, the simplest mode of solution is to begin at any point, and go through all (through some, perhaps, more than once) till we return



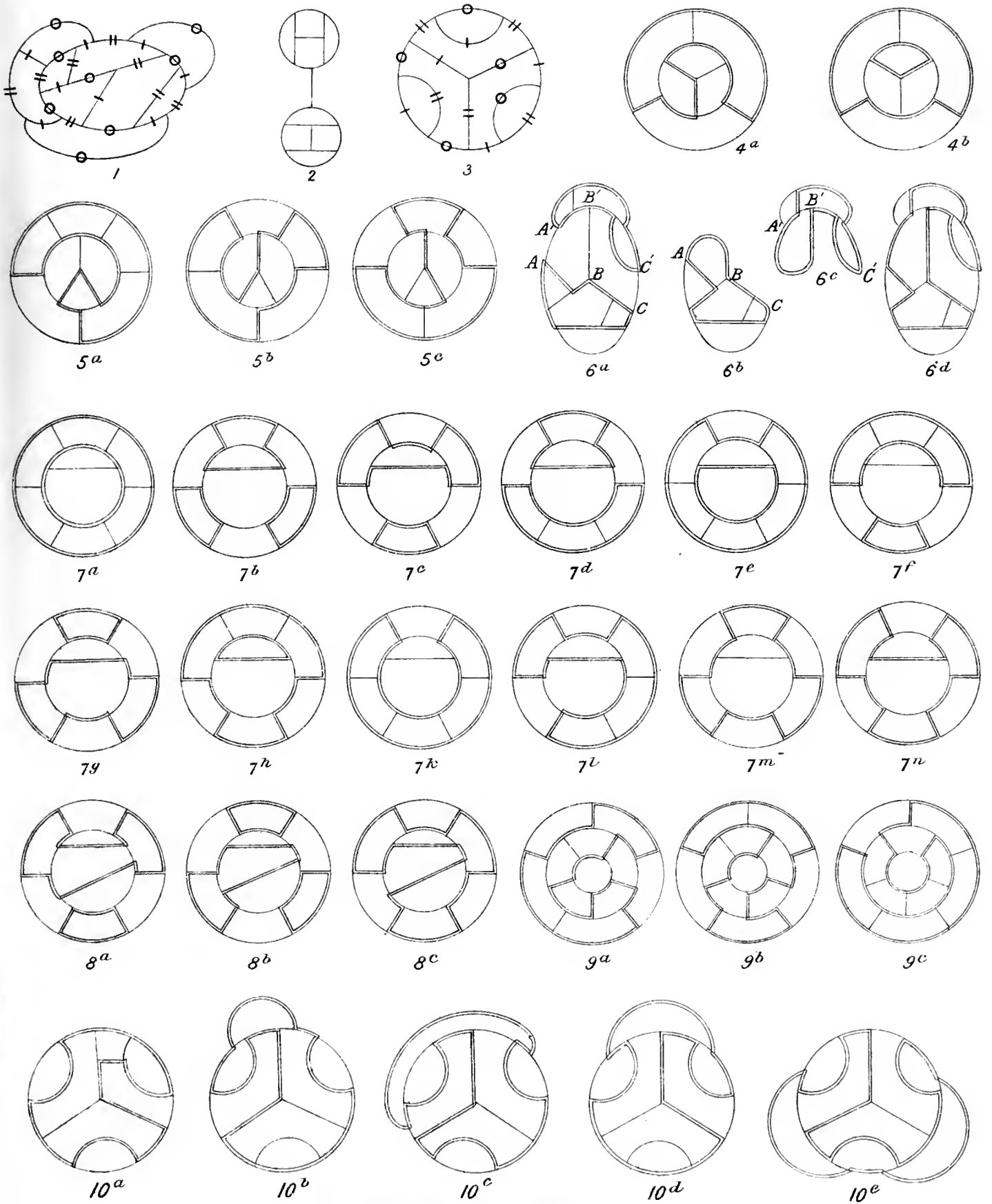



to the starting-point. Then treat, as not gone over, all the lines which have been gone over an even number of times. This process is very easily learned by trial, the only special rule to be attended to being that we must never isolate a point. Should two odd-sided polygons be thus obtained, we may either begin afresh:—or go over a second time, attending to the above rule, part of the region of the figure in which these two polygons are contained. It is easy to see the connection of this method with the idea of a galvanic circuit of unit strength circulating (say right-handedly) in each of the polygons:—and the treating of any new or unused line as a conductor which can, when necessary, be split into two traversed by equal and opposite currents. It is probable that the known laws of such currents in a network may lead to the proof of the existence of a single polygon when the figure is a projection of a polyhedron.

7. Another method is suggested by Mr Kempe's solution of the map-colouring problem (*Nature*, vol. XXI. p. 399). As the number of districts is, necessarily,  $n + 2$ , and the aggregate number of their sides  $6n$ , there must always be at least one district with fewer than six sides. Now, one side may be erased from a district of two or of three sides, and restored again, without altering the nomenclature of the remaining lines. Similarly, either pair of opposite sides of a four-sided district may be erased, and afterwards restored. But when we erase any two non-adjacent sides of a five-sided district, a condition is thereby imposed on the nomenclature of the remaining lines, with which I do not yet see how generally to deal.

8. An immediate consequence of the theorem is that, in any network of *triangles* (however many lines meet at a point) the sides of each triangle belong one to each of three groups into which the whole set of lines can be divided. The theorem itself follows, conversely, if this proposition be independently proved.

9. In No. 494 of the *Astronomische Nachrichten*, Clausen has a problem closely connected with the present subject. It refers to the minimum number of separate strokes of a pen by which a given figure consisting of lines can be drawn. Listing, in his *Vorstudien zur Topologie*, has shown how to find this minimum number by counting the points at which an odd number of lines meet. In our present proposition, if one polygon can be found containing all the points, *it* and *one* of the unused lines together form *one* penstroke, and the remaining group of  $n - 1$  unused lines forms the rest. If there be two polygons, they and one of the unused lines together form one penstroke. And so on.

10. To apply the result above to the problem of map-colouring, insert a new district surrounding each point of the map where more than three boundaries meet. Then divide the boundaries, which now meet in threes, into three groups as above. (The excepted case obviously cannot arise.) Now let  $\bigcirc$  separate the colours *A* and *B*, or *C* and *D*; |, *A* and *C*, or *B* and *D*; and ||, *A* and *D*, or *B* and *C*; and the thing is done. For we may now suppose the inserted districts to become smaller, till they vanish.

## LV.

## ON MINDING'S THEOREM.

[*Transactions of the Royal Society of Edinburgh.* Revised June 23, 1880.]

THE following paper contains a short digest of investigations communicated to the Society on several occasions during the past, and the present, session. The work had been for some months laid aside, but my attention was recalled to it by Professor Chrystal's valuable paper\*, in which he treats Minding's Theorem as an example of Plücker's methods, and also by the help of Rodrigues' co-ordinates. I am induced to publish a few of my results in full, as I think that a comparison of the analysis employed by Chrystal, with the very different analysis employed by myself, may be useful as well as interesting, especially from the point of view of the simplicity of the quaternion method. Even when the quaternion processes are written out at full length, they are in general shorter than the most condensed forms of ordinary analysis; and there can be no doubt that they are much more easily interpretable into the corresponding geometrical ideas.

A hastily-written proof of the main theorem, somewhat on the same lines as the first of those now given, was printed in the *Proceedings of the London Mathematical Society*, No. 147. But the present version is much simpler; and it is requisite for the intelligibility of the rest of the paper which, I repeat, is given mainly for the sake of the quaternion processes involved.

I commence with a few preliminary transformations. This would be altogether needless if quaternion methods were at all as familiar to the majority of mathematical readers as are the more usual ones.

1. In what follows we have a good deal of use to make of certain properties of linear and vector functions, so that some of the less obvious of them are here briefly stated.

\* "On Minding's System of Forces." *Trans. R.S.E.* xxix. p. 519.

Let  $\alpha_1, \alpha_2, \dots, \beta_1, \beta_2, \dots$ , be any two sets of vectors, and let us consider the vector

$$\kappa = \Sigma V\beta\alpha \dots\dots\dots(1).$$

If we operate by  $V \cdot \sigma$ , where  $\sigma$  is any vector whatever, we have

$$\begin{aligned} V\sigma\kappa &= V \cdot \sigma \Sigma V\beta\alpha \\ &= \Sigma (\alpha S\beta\sigma - \beta S\alpha\sigma) \\ &= (\phi - \phi') \sigma \dots\dots\dots(2) \end{aligned}$$

$$= 2V\epsilon\sigma \dots\dots\dots(3),$$

if  $V \cdot \epsilon$  be the impure part of the strain

$$\phi = \Sigma \alpha S\beta ( ) \dots\dots\dots(4).$$

Hence if  $\phi$  be put (as can always be done) in the normal form

$$\zeta Si ( ) + \eta Sj ( ) + \theta Sk ( ),$$

where  $i, j, k$  form a rectangular unit system; we have

$$\kappa = \Sigma V\beta\alpha = V(i\zeta + j\eta + k\theta) \dots\dots\dots(5).$$

In the particular case which we shall chiefly require, it will be found that there is a certain vector  $\bar{\beta}$  such that

$$\phi \bar{\beta} = 0.$$

Hence we may write  $\phi$  in the form

$$\gamma' S\gamma ( ) + \delta' S\delta ( )$$

where  $\gamma, \delta$  are any two unit vectors perpendicular to each other and to  $\bar{\beta}$ . If, now, we change

$$\gamma \text{ to } \gamma \cos \mathfrak{D} + \delta \sin \mathfrak{D},$$

and

$$\delta \text{ to } -\gamma \sin \mathfrak{D} + \delta \cos \mathfrak{D},$$

(which are still unit vectors, perpendicular to one another, and to  $\bar{\beta}$ )

$$\gamma' \text{ becomes } \gamma' \cos \mathfrak{D} - \delta' \sin \mathfrak{D},$$

and

$$\delta' \text{ ,, } \gamma' \sin \mathfrak{D} + \delta' \cos \mathfrak{D}.$$

These are at right angles to one another if

$$\tan 2\mathfrak{D} = \frac{2S'\gamma'\delta'}{\delta'^2 - \gamma'^2}.$$

This always gives real values of  $\mathfrak{D}$ , corresponding to two definite directions at right angles to one another. Hence we may always take

$$\phi = \gamma' S\gamma ( ) + \delta' S\delta ( ) \dots\dots\dots(4')$$

where  $\gamma$  and  $\delta$  are as before, and  $\gamma'$  and  $\delta'$  are vectors at right angles to one another.

Another point to be borne in mind is that rotation of a rigid system may be expressed by a special linear and vector function,  $\chi$ , which possesses the following characteristic properties;

$$S\chi\alpha\chi\beta = S\alpha\beta,$$

(of which a particular case is

$$T\chi\alpha = T\alpha,)$$

and

$$V\chi\alpha\chi\beta = \chi V\alpha\beta.$$

Also the conjugate of  $\chi$  is its reciprocal, or

$$\chi' = \chi^{-1}.$$

These premised, we may attack the question.

2. When any number of forces act on a rigid system;  $\beta_1$  at the point  $\alpha_1$ ,  $\beta_2$  at  $\alpha_2$ , &c., their resultant consists of the single force

$$\bar{\beta} = \Sigma\beta$$

acting at the origin, and the couple

$$\kappa = \Sigma V\beta\alpha \dots\dots\dots(1).$$

If these can be reduced to a single force, the equation of the line in which the force acts is evidently

$$V\bar{\beta}\rho = \Sigma V\beta\alpha \dots\dots\dots(5).$$

Now suppose the system of forces to turn about, preserving their magnitudes, their points of application, and their mutual inclinations, then Minding's Theorem, proved (in *Crelle's Journal*, vols. XIV., XV.) by an excessively elaborate process, assigns certain fixed curves in space, each of which is intersected by the line (5) in every one of the infinite number of its positions.

3. To prove this, and to find the curves in question, we may proceed as follows:—

Operating on (5) by  $V.\bar{\beta}$ , it becomes

$$\rho\bar{\beta}^2 - \bar{\beta}S\bar{\beta}\rho = \phi\bar{\beta} - \phi'\bar{\beta}$$

with the notation of (2). Now, however the forces may turn,

$$\phi\bar{\beta} = \Sigma\alpha S\beta\bar{\beta}$$

is an absolute constant; for each scalar factor as  $S\beta_1\bar{\beta}$  is unaltered by rotation. Let us therefore change the origin, *i.e.*, the value of each  $\alpha$ , so as to make

$$\Sigma\alpha S\beta\bar{\beta} = 0,$$

*i.e.*,

$$\phi\bar{\beta} = 0 \dots\dots\dots(6).$$

Thus we see that  $\phi$  may be expressed in the form given in (4') above.

4. Equation (5) is now

$$bV\beta\rho = V\gamma\gamma' + V\delta\delta' \dots\dots\dots(5')$$

where  $b$  is the tensor, and  $\beta$  the versor, of  $\bar{\beta}$ .

The condition that the force shall lie in the plane of the couple is, of course, included in this, and is found by operating by  $S \cdot \beta$ . Thus

$$S(\delta\gamma' - \gamma\delta') = 0 \dots\dots\dots(7).$$

We have here all the data of the problem, and solutions can only differ from one another in the mode of attacking (5') and (7). The most purely quaternionic mode, so far as Hamilton developed his calculus, seems to be the following:—

Writing (7) in the form

$$S\gamma(\delta' + V\beta\gamma') = 0,$$

we have at once

$$\left. \begin{aligned} t\gamma &= V\beta\delta' + \beta V\beta\gamma', \\ t\delta &= -V\beta\gamma' + \beta V\beta\delta', \end{aligned} \right\} \dots\dots\dots(7')$$

whence

where  $t$  is an undetermined scalar.

By means of these we may put (5') in the form

$$\begin{aligned} btV\beta\rho &= V \cdot \beta (V\gamma'\delta' + \gamma'S\gamma'\beta + \delta'S\delta'\beta) \\ &= V \cdot \beta (V\gamma'\delta' - \varpi\beta), \end{aligned}$$

where

$$\varpi = -\gamma'S\gamma'(\ ) - \delta'S\delta'(\ ).$$

Let the tensors of  $\gamma'$  and  $\delta'$  be  $e_1, e_2$  respectively, and let  $\beta'$  be a unit vector perpendicular to them, then we may write

$$bt\rho = x\beta + e_1e_2\beta' - \varpi\beta \dots\dots\dots(8).$$

Operating by  $(\varpi - x)^{-1}$ , and noting that

$$\varpi\beta' = 0,$$

we have

$$bt(\varpi - x)^{-1}\rho = -\beta - \frac{e_1e_2}{x}\beta' \dots\dots\dots(8').$$

Taking the scalar of the product of (8) and (8') we have

$$b^2t^2S\rho(\varpi - x)^{-1}\rho = -\frac{1}{x}(x\beta + e_1e_2\beta')^2 - S\beta\varpi\beta.$$

But by (7') we have

$$t^2 = S\beta\varpi\beta + e_1^2 + e_2^2 - 2e_1e_2S\beta\beta' \dots\dots\dots(9)$$

so that, finally,

$$b^2S\rho(\varpi - x)^{-1}\rho = -1 + \frac{(e_1^2 - x)(e_2^2 - x)}{xt^2} \dots\dots\dots(10).$$

5. Equation (10), in which  $t^2$  is given by (9) in terms of  $\beta$ , is true for every point of every single resultant. But we get an immense simplification by assuming for  $x$  either of the particular values  $e_1^2$  or  $e_2^2$ . For then the right-hand side of (10) is reduced to negative unity, and the equation represents one or other of the focal conics of the system of confocal surfaces

$$S\rho(\varpi - h)^{-1}\rho = -\frac{1}{b^2},$$

a point of each of which must therefore lie on the line (8). This is Minding's Theorem.

6. A singular form, in which it can be expressed, appears at once from equation (5'). For that equation is obviously the condition that the linear and vector function

$$-b\rho S\beta(\ ) + \gamma'S\gamma(\ ) + \delta'S\delta(\ )$$

shall denote a pure strain.

Hence the following problem:—*Given a set of rectangular unit vectors, which may take any initial position: let two of them, after a homogeneous strain, become given vectors at right angles to one another, find what the third must become that the strain may be pure.* The locus of the extremity of the third is, for every initial position, one of the single resultants of Minding's system; and therefore passes through each of the fixed conics.

Thus we see another very remarkable analogy between strains and couples, which is in fact suggested at once by the general expression for the impure part of a linear and vector function.

7. The scalar  $t$ , which was introduced in equations (7'), is shown by (9) to be a function of  $\beta$  alone. In this connection it is interesting to study the surface of the fourth order

$$S\tau\varpi\tau - (e_1^2 + e_2^2)\tau^2 - 2e_1e_2T\tau S\beta'\tau = 1,$$

where 
$$\tau = \frac{1}{t}\beta.$$

But this may be left as an exercise.

Another form of  $t$  (by 7') is  $S\gamma\gamma' + S\delta\delta'$ .

Meanwhile (9) shows that for any assumed value of  $\beta$  there are but two corresponding Minding lines.

If, on the other hand,  $\rho$  be given there are in general four values of  $\beta$ . For variety we may take a different mode of attacking equations (7) and (5'), which contain the whole matter. In what follows  $b$  will be merged in  $\rho$ .

8. Operating by  $V.\beta$  we transform (5') into

$$\rho + \beta S\beta\rho = -(\gamma S\gamma'\beta + \delta S\delta'\beta) \dots\dots\dots(5'')$$

Squaring both sides we have

$$\rho^2 + S^2\beta\rho = S\beta\varpi\beta \dots\dots\dots(11).$$



Since  $\beta$  is a unit vector, this may be taken as the equation of a cyclic cone; and every central axis through the point  $\rho$  lies upon it. For we have not yet taken account of (7), which is the condition that there shall be no couple.

To introduce (7), operate on (5'') by  $S.\gamma'$  and by  $S.\delta'$ . We thus have, by a double employment of (7),

$$\left. \begin{aligned} S\gamma'\rho + S\gamma'\beta S\beta\rho &= S\gamma\omega\beta \\ S\delta'\rho + S\delta'\beta S\beta\rho &= S\delta\omega\beta \end{aligned} \right\} \dots\dots\dots(12).$$

Next, multiplying (11) by  $S\beta\omega\beta$ , and adding to it the squares of (12), we have

$$\rho^2 S\beta\omega\beta - 2S\beta\rho S\beta\omega\rho - S\rho\omega\rho = -S\beta\omega^2\beta \dots\dots\dots(13).$$

This is a second cyclic cone, intersecting (11) in the four directions  $\beta$ . Of course it is obvious that (11) and (13) are unaltered by the substitution of  $\rho + \gamma\beta$  for  $\rho$ .

If we look on  $\beta$  as given, while  $\rho$  is to be found, (11) is the equation of a right cylinder, and (13) that of a central surface of the second order.

9. A curious transformation of these equations may be made by assuming  $\rho_1$  to be any other point on one of the Minding lines represented by (11) and (13). Introducing the factor  $-\beta^2 (=1)$  in the terms where  $\beta$  does not appear, and then putting throughout

$$\beta \parallel \rho_1 - \rho \dots\dots\dots(14),$$

(11) becomes

$$-\rho^2\rho_1^2 + S^2\rho\rho_1 = S(\rho_1 - \rho)\omega(\rho_1 - \rho) \dots\dots\dots(11').$$

As this is symmetrical in  $\rho, \rho_1$ , we should obtain only the same result by putting  $\rho_1$  for  $\rho$  in (11), and substituting again for  $\beta$  as before.

From (13) we obtain the corresponding symmetrical result

$$(\rho^2 - S\rho\rho_1)S\rho_1\omega\rho_1 + (\rho_1^2 - S\rho\rho_1)S\rho\omega\rho = -S\rho\rho_1 S(\rho_1 - \rho)\omega(\rho_1 - \rho) - S(\rho_1 - \rho)\omega^2(\rho_1 - \rho) \dots(13').$$

These equations become very much simplified if we assume  $\rho$  and  $\rho_1$  to lie respectively in any two conjugate planes; specially in the planes of the focal conics, so that  $S\delta'\rho = 0$ , and  $S\gamma'\rho_1 = 0$ .

For if the planes be conjugate we have

$$S\rho\omega\rho_1 = 0,$$

$$S\rho\omega^2\rho_1 = 0,$$

and if, besides, they be those of the focal conics,

$$S\rho\rho_1 = -S\beta'\rho S\beta'\rho_1,$$

$$S\rho\omega^2\rho = e_1^2 S\rho\omega\rho, \text{ \&c.,}$$

and the equations are

$$-\rho^2\rho_1^2 + S^2\rho\rho_1 = S\rho_1\omega\rho_1 + S\rho\omega\rho \dots\dots\dots(11''),$$

and

$$\rho^2 S\rho_1\omega\rho_1 + \rho_1^2 S\rho\omega\rho = -S\rho_1\omega^2\rho_1 - S\rho\omega^2\rho \dots\dots\dots(13'').$$

T.

From these we have at once the equations of the two Minding curves in a variety of different ways. Thus, for instance, let

$$\rho_1 = p\delta'$$

and eliminate  $p$  between the equations. We get the focal conic in the plane of  $\beta', \gamma'$ . In this way we see that Minding lines pass through each point of each of the two curves; and by a similar process that every line joining two points, one on the one curve the other on the other, is a Minding line.

Another process is more instructive. Note that, by the equations of condition above, we have

$$S^2\rho\rho_1 = \left(\frac{S\rho_1\varpi\rho_1}{e_2^2} - \rho_1^2\right) \left(\frac{S\rho\varpi\rho}{e_1^2} - \rho^2\right).$$

Then our equations become

$$\frac{S\rho\varpi\rho S\rho_1\varpi\rho_1}{e_1^2 e_2^2} - \frac{\rho_1^2 + e_1^2}{e_1^2} S\rho\varpi\rho - \frac{\rho^2 + e_2^2}{e_2^2} S\rho_1\varpi\rho_1 = 0,$$

and

$$(\rho^2 + e_2^2) S\rho_1\varpi\rho_1 + (\rho_1^2 + e_1^2) S\rho\varpi\rho = 0.$$

If we eliminate  $\rho^2$  or  $\rho_1^2$  from these equations, the resultant obviously becomes divisible by  $S\rho\varpi\rho$  or  $S\rho_1\varpi\rho_1$ , and we at once obtain the equation of one of the focal conics.

10. In passing it may be well to notice that equation (13) may be written in the simpler form

$$S \cdot \rho\beta\rho\varpi\beta + S\rho\varpi\rho = S\beta\varpi^2\beta.$$

Also it is easy to see that if we put

$$\theta = \rho S\beta\rho - (\varpi + \rho^2)\beta$$

we have (11) in the form

$$S\beta\theta = 0,$$

and by the help of this (13) becomes

$$\theta^2 = S\rho\varpi\rho.$$

This gives another elegant mode of attacking the problem.

11. Another valuable transformation of (5'') is obtained by considering the linear and vector function,  $\chi$  suppose, by which  $\beta, \gamma, \delta$  are derived from the system  $\beta', U\gamma', U\delta'$ . For then we have obviously

$$\rho = x\chi\beta' + \chi\varpi^{\frac{1}{2}}\chi\beta' \dots\dots\dots(5''').$$

This represents any central axis, and the corresponding form of the Minding condition is

$$S \cdot \gamma'\chi\varpi^{-\frac{1}{2}}\delta' = S \cdot \delta'\chi\varpi^{-\frac{1}{2}}\gamma' \dots\dots\dots(7''').$$

Most of the preceding formulæ may be looked upon as results of the elimination of the function  $\chi$  from these equations. This forms probably the most important feature of such investigations, so far at least as the quaternion calculus is concerned.

I employed the equation (5''') as the basis of an investigation, one or two of whose results were communicated last session to the Society\*. I will now give the main features of that investigation.

12. It is evident from (5''') that the vector-perpendicular from the origin on the central axis parallel to  $\chi\beta'$  is expressed by

$$\tau = \chi\varpi^{\frac{1}{2}}\chi\beta'.$$

But there is an infinite number of values of  $\chi$  for which  $U\tau$  is a given versor. Hence the problem;—to find the maximum and minimum value of  $T\tau$ , when  $U\tau$  is given—*i.e.*, to find the surface bounding the region which is filled with the feet of perpendiculars on central axes.

We have

$$T\tau^2 = -S.\chi\beta'\varpi\chi\beta',$$

$$0 = T\tau S.\chi\beta'U\tau.$$

Hence

$$0 = S.\dot{\chi}\beta'\varpi\chi\beta',$$

$$0 = S.\dot{\chi}\beta'U\tau.$$

But as  $T\beta'$  is constant

$$0 = S.\dot{\chi}\beta'\chi\beta'.$$

These three equations give at sight

$$(\varpi + u)\chi\beta' = u'U\tau,$$

where  $u, u'$  are unknown scalars. Operate by  $S.\chi\beta'$  and we have

$$-T^2\tau - u = 0,$$

so that

$$S\tau(\varpi + \tau^2)^{-1}\tau = 0.$$

This differs from the equation of Fresnel's wave-surface only in having  $\varpi + \tau^2$  instead of  $\varpi + \tau^{-2}$  (*i.e.*,  $T\tau$  for  $\frac{1}{T\tau}$ ), and denotes therefore the reciprocal of that surface. In the statical problem, however, we have

$$\varpi\beta' = 0,$$

and thus the corresponding wave-surface has zero for one of its parameters.

[If this restriction be not imposed, the locus of the point

$$\tau = \chi\phi\chi\beta',$$

where  $\phi$  is now any given linear and vector function whatever, will be found, by a process precisely similar to that just given, to be

$$S.(\tau - \phi'\beta')(\phi'\phi + \tau^2)^{-1}(\tau - \phi'\beta') = 0,$$

where  $\phi'$  is the conjugate of  $\phi$ . This, however, has nothing to do with Minding's Theorem.]

\* *Proc. Roy. Soc. Edin.*, 1879, p. 200.

13. As the reader may not feel secure of results derived by the differentiation of a vector function operator, it may be well to obtain the result of last section by a more usual process.

We obviously have by (5'')

$$\tau = \gamma S\gamma' \beta + \delta S\delta' \beta,$$

or, as in (11),

$$\tau^2 = S\beta \varpi \beta.$$

But also

$$S\beta U\tau = 0.$$

$$\beta^2 = -1.$$

To make  $T\tau$  a maximum with these conditions, we have

$$\left. \begin{aligned} S\dot{\beta} \varpi \beta &= 0 \\ S\dot{\beta} U\tau &= 0 \\ S\dot{\beta} \beta &= 0 \end{aligned} \right\},$$

and, by elimination of  $\beta$  and  $\dot{\beta}$  among these equations, we have as before

$$S\tau(\varpi + \tau^2)^{-1} \tau = 0.$$

The first of the undifferentiated equations is that of an elliptic cylinder of variable magnitude but constant form and position, the second a diametral plane, and the third the unit sphere. Obviously there is one maximum and one minimum value of  $T\tau$ . These occur when the variable ellipse given by the first and second equations *touches* the fixed circle given by the second and third. It may do so internally or externally, and consequently the resulting equation gives two values of  $T\tau$  for each value of  $U\tau$ .

14. This is, in fact, in quaternions identical with the second process employed by Professor Chrystal. For, by writing  $\tau$  for  $\rho + \beta S\beta \rho$  in (11) it becomes

$$\tau^2 = S\beta \varpi \beta,$$

and in the same way (13) becomes

$$\tau^4 - S\tau \varpi \tau = -S\beta \varpi^2 \beta.$$

These, translated into Cartesian scalars, are Chrystal's equations (8) and (9) (*Second Method, Trans. R.S.E.*, XXIX., p. 523). They may be obtained directly by a process similar to that in section 8 above. Chrystal's first method is, of course, included in the solutions afforded by the use of  $\chi$ .

I may remark, in conclusion, that the process of section 4, leading to an equation like (10) above, seems to be the most natural method of applying quaternions to questions connected with congruencies.

## APPENDIX.

## ON SOME SPACE-LOCI.

[*Proceedings of the Royal Society of Edinburgh, March 21, 1881.*]

(*Abstract.*)

THE class of problems treated is one to which considerable attention has been paid of late, as for instance by Glaisher and others in this country, and by Mannheim, &c., abroad.

Two years ago (*Proc. R.S.E.* 1879, p. 200), in connection with Minding's Theorem, I investigated the space-locus of the feet of perpendiculars from the origin on the rays of a complex. These were found to fill the space bounded by the two sheets of the reciprocal of a Fresnel's wave-surface. The method I employed is capable of very extended application in the same direction, and the following general process is applicable to all the problems I have seen treated by the authors above referred to.

Let  $\rho = \alpha + x\beta$ ,  
 where  $T\beta = 1$ ,  
 be any ray of a complex; and let the scalar condition determining a point on it be  $F(\rho) = 0$ .

This determines  $x$  in terms of  $\alpha, \beta$ ; and the number of independent scalar variables is reduced by two additional data, such as a relation between  $\alpha$  and  $\beta$  (e.g.,  $S.\alpha\beta = 0$ ), or a relation among the values of  $x$  (e.g.,  $f(x_1, x_2, \dots) = 0$ ), according to the nature of the complex.

We have now to make  $T\alpha$  a maximum or minimum, subject to the additional condition that

$$U\alpha = \text{constant.}$$

This gives rise to three scalar equations which may be written

$$S.\dot{\beta}\beta = 0,$$

$$S.\dot{\beta}v_1 = 0,$$

$$S.\dot{\beta}v_2 = 0,$$

or, finally,

$$S.\beta v_1 v_2 = 0,$$

i.e.,  $\beta$  is coplanar with  $v_1, v_2$ , which are usually normals to surfaces at the points of intersection with a ray of the complex. This is one of the chief points of Mannheim's

treatment of the subject. When, as is often the case, the surface on which the complex is made to depend is an ellipsoid

$$S \cdot \rho \phi \rho = 1 ;$$

the last written equation usually takes the form

$$\beta + y\phi\beta + z\alpha = 0,$$

or

$$\beta = -z(y\phi + 1)^{-1} \alpha,$$

whence

$$-1 = z^2 S \cdot \alpha (y\phi + 1)^{-2} \alpha.$$

In this equation  $y$  and  $z$  depend upon  $T\alpha$ , so that the space-locus is closely connected with Fresnel's wave-surface, whose equation is capable of a very remarkable series of transformations, depending on the properties of the expression

$$S \cdot \alpha (\phi + g)^{-1} \alpha.$$

## LVI.

## A ROTATORY POLARIZATION SPECTROSCOPE OF GREAT DISPERSION.

[*Nature*, Vol. xxii., 1880.]

I HAVE just had an opportunity of trying, on a fine aurora, an instrument for measuring the wave-length of monochromatic light in terms of quartz-rotation of its plane of polarization. My apparatus is, as yet, very roughly put together, so that I got no measurements of any value, but to-night's experience has shown me that the method, while simple in application, is capable of very great accuracy.

The construction of the instrument will be easily understood from the annexed rough sketch. The course of the light is with the arrows. *N* is a Nicol, *S* an adjustable slit, *L* a lens at its focal distance from *S*, *Q* a plate of quartz cut perpendicularly to the axis, *P* a double-image prism, and *E* a small direct-vision spectroscope, which may be dispensed with when absolutely monochromatic light is to be examined.

When the instrument is properly adjusted by daylight the two images of *S* formed by *P* are parts of a straight line, so that *E* gives two spectra side by side. These are crossed by dark bands, which are numerous in proportion to the thickness of *Q*, and move along the spectra as *N* is made to rotate.

In observing a bright-line spectrum the slit is to be made as wide as possible, subject to the condition that no two of the differently-coloured images shall overlap. We have thus a pair of juxtaposed rectangles for each of the bright lines, and the angular positions of *N*, when the members of the several pairs are *equally bright*, are read off on a divided head. I find by trial that a division to  $2^\circ$  is quite sufficient.



A *first* set of readings is taken with a plate *Q* (permanently fixed in the instrument) 5 or 6 millimetres thick. Then an additional plate of quartz 100 millimetres or more thick is introduced between *Q* and *L*, and a *second* set of readings is taken. From the readings with the thin plate we find approximately the positions of the spectral lines, and the more exact determination is obtained from the readings with the thick plate.

This is the chief feature of the instrument. The actual error of any one reading is not more than  $2^\circ$ , but when a thick plate is used the whole rotation may be from ten to twenty or even thirty circumferences. By thus increasing the thickness of the quartz plate *very* little additional loss of light is incurred, while the inevitable error forms a smaller and smaller fraction of the whole quantity to be measured.

The graduation of the instrument is to be effected by very careful measurements upon a hydrogen Geissler tube, and comparison with the known wave-lengths of the hydrogen lines.

An observer furnished with this instrument (which is not much larger than a pocket spectroscope) and with a long rod of quartz, will be able to make measurements of any required degree of accuracy.



## LVII.

## NOTE ON A SINGULAR PROBLEM IN KINETICS.

[*Proceedings of the Royal Society of Edinburgh, March 7, 1881.*]

THE following problem presented itself to me nearly thirty years ago. I cannot find any notice of it in books, though it must have occurred to every one who has studied the oscillations of a balance:—

*Two equal masses are attached to the ends of a cord passing over a smooth pulley (as in Atwood's machine). One of them is slightly disturbed, in a vertical plane, from its position of equilibrium. Find the nature of the subsequent motion of the system.*

The interest of this case of small motions is twofold. From the peculiar form of the equations of motion, it is of exceptional mathematical difficulty. This is probably the reason for its not having been given as an example in Kinetics. And from the physical point of view it presents a very beautiful example of excessively slow, but continued, transformation of mixed potential and kinetic energy into kinetic energy alone.

If  $r$  and  $\theta$  denote the polar coordinates of the disturbed mass, we have (supposing the curvature of the pulley to be large) by Lagrange's method—

$$2\ddot{r} - r\dot{\theta}^2 = -\frac{1}{2}g\theta^2,$$

$$\frac{d}{dt}(r^2\dot{\theta}) = -gr\theta.$$

Writing  $\frac{1}{2}gr$  for  $r$ , and  $\theta\sqrt{2}$  for  $\theta$ , these become—

$$\ddot{r} - r\dot{\theta}^2 = -\theta^2,$$

$$\frac{d}{dt}(r^2\dot{\theta}) = -2r\theta.$$

Hence, the motion of the disturbed mass is [of] the same [character] as that of a particle of unit mass under forces  $-\theta^2$  along, and  $-2\theta$  perpendicular to, the radius vector.

[The work done by or against this system, along any arc of a curve, is the difference between the values of  $r\theta^2$  at its ends.]

Changing to rectangular coordinates ( $x$  vertical), and maintaining the same degree of approximation as before, we have—

$$\left. \begin{aligned} \ddot{x} &= \frac{y^2}{x^2}, \\ \ddot{y} &= -\frac{2y}{x} \end{aligned} \right\} \dots\dots\dots(1).$$

The first suffices, without farther analysis, to show that the vertical acceleration of the disturbed mass is persistently downwards. Hence, the result of the disturbance must be the continuous transformation of the mixed potential and kinetic energy, of the vibration originally given to the disturbed mass, into kinetic energy of translation of the whole system.

The equation of energy is easily seen to be—

$$\frac{1}{2} (\dot{x}^2 + \dot{y}^2) + \frac{y^2}{x} = C;$$

and here the term  $\frac{y^2}{x}$  has an infinite series of successively diminishing maxima.

From some rough calculations I find that the amplitude of  $y$  increases, but much more slowly in percentage value than does  $x$ ; so that the maximum inclination of the vibrating part of the string to the vertical constantly diminishes.

It would be interesting to obtain an approximate solution of the equations (1), and to compare the motion of the vibrating mass with that of a simple pendulum whose cord is uniformly lengthened. The equation for the latter case has been fully treated by Fourier in his *Théorie de la Chaleur*.

When both masses (in the original problem) are simultaneously disturbed, it appears from the equations of motion that that mass whose end of the cord vibrates through the greater angle will have downward acceleration. As this in the former case was found to be accompanied by a diminution of the angle, the angle of the ascending mass should increase; and thus it would seem that after a time the downward acceleration will change sign. Thus (if the string were long enough) the vertical motions of the system would be oscillatory. But this curious result cannot be verified without proceeding to a formal approximation. I have not found time to carry out this laborious but not difficult work.

Another variety of the problem is easily formed by seeking the requisite ratio of the two masses, so that the motion shall be wholly periodic, with a period equal to that of the vibration of the disturbed mass. This is, relatively to the above, a very simple question.

## LVIII.

## ON MIRAGE.

[*Transactions of the Royal Society of Edinburgh*, Vol. xxx. Read December 5, 1881.]

I WAS led to the following investigations while seeking an elementary, and at the same time instructive, application of Hamilton's *General Method in Optics*\*. They were completed in all but a few of their numerical details before I met with the remarkable paper by Wollaston†, in which the subject of multiple atmospheric images seems first to have been treated by a sound physical method. Wollaston's experiment with a long bar of iron raised to a high temperature suggests undoubtedly the true explanation of at least many of the curious phenomena seen by Vince‡, Scoresby§, and others. But he seems to have thought that sufficient temperature-differences for the natural production of the phenomena could not exist in the atmosphere; and thus the latter part of his paper, in which he tries to explain them by the agency of aqueous vapour, presents a singular contrast to the strength and correctness of the earlier part. A good deal of what follows is implied, if not directly stated, in Wollaston's paper; but I think there is sufficient novelty in what remains to justify my bringing it before the Society.

The subject is one which offers immense facilities for the construction of elegant "Problems," but I have confined myself to the simplest hypotheses which (while enabling me to obtain exact results) promised to throw light upon it:—feeling that anything else would be out of place in endeavouring to explain a class of phenomena which have probably never occurred twice in exactly the same way. I have, however, shown at least the *general* nature of the alterations to which my results would be subject in consequence of modification of the assumptions.

\* *Trans. R. I. A.*, 1833.

‡ *Phil. Trans.*, 1799.

† *Phil. Trans.*, 1800.

§ *Greenland*, and *Trans. Roy. Soc. Edin.*, ix. and xi.

1. Most of the images seen by Scoresby were inverted, and elevated above the apparent position of the object seen directly, and each series of them (when there were more series than one) can be explained at once by the existence of a horizontal stratum of air in which the rate of diminution of refractive index in ascending is greater than that in the air immediately below. [This is merely the sort of arrangement which, as is perfectly well known, produces the mirage of the desert; but turned upside down.] But the chief phenomenon figured by Vince, and also in a few cases by Scoresby, involves an inverted image with a direct image above it. In some other cases observed by Scoresby, the direct or the inverted image alone was seen, the object itself being situated far below the horizon. Some excerpts from Scoresby's figures (which are themselves *composite*) are given in Plate XI., fig. 1. A comparison of these observations with Vince's diagram of the supposed courses of the rays seemed to me to show that a *single* transition stratum may be capable of giving either a single image, direct or inverted according to circumstances, or an inverted image with a direct image above it. As, in at least the greater number of the observations to which I have referred, both the object and the spectator seem to have been *below* the transition stratum which caused the phenomena, I do not think that Wollaston's square bottle with two interdiffusing liquids presents a fair analogy. For, with that arrangement, the rays enter and emerge from the transition stratum by its ends, and not by its lower side, as, from Vince's diagram, they would appear to do in nature.

I propose to return to the consideration of this arrangement of Wollaston's. But meanwhile I will sketch (1) the mode in which I was led to see that, under proper conditions, a simple *continuous* law of refractive index may lead to the formation of three images, (2) how the consideration of the mode in which these are produced in a medium whose refractive index varies to four-fold or more of the minimum value, led me by *necessary* steps to see how they can be produced in the lower atmosphere whose refractive index can vary, even in extreme cases, by only 1/40,000 or so.

2. To fix the ideas, we will begin with a particular case, which is a thoroughly illustrative one so far as theory is concerned, and is also interesting as it reproduces, with singular accuracy, the exaggerated diagram by which Vince endeavoured to explain his observations.

The ordinary characteristic of a maximum or minimum is that it differs from neighbouring values of the function by a quantity depending on the *square* of the increment of the independent variable. Assuming then, without any inquiry as to the other physical circumstances, the existence of a medium whose refractive index is represented by the equation

$$\mu^2 = a^2 + y^2,$$

it is clear that  $y=0$  is a plane of minimum refractive index.

Hamilton's equation for this case is,  $\tau$  being the characteristic function,

$$\left(\frac{d\tau}{dx}\right)^2 + \left(\frac{d\tau}{dy}\right)^2 = a^2 + y^2 \dots\dots\dots(1),$$

since it is obvious that the path is in a plane perpendicular to  $y = 0$ .

A complete integral is

$$\tau = \alpha x + \int dy \sqrt{a^2 + y^2 - \alpha^2}.$$

Hence the equation of a ray is

$$C = x - \alpha \int \frac{dy}{\sqrt{a^2 + y^2 - \alpha^2}} \dots\dots\dots(2).$$

[This result might, of course, have been at once obtained from the corpuscular theory. For its principles give

$$\dot{x} = \alpha, \quad \dot{y} = \sqrt{a^2 + y^2 - \alpha^2}.]$$

Equation (2) has two distinct forms according as  $\alpha$  is greater or less than  $a$ . These are separated by the limiting form when  $\alpha = a$ , viz. :—

$$y = C_1 e^{x/a},$$

a logarithmic curve asymptotic to the axis of  $x$ . When  $\alpha$  is less than  $a$ , the ray passes through the plane  $y = 0$ , and we need not consider it further.

We may therefore assume

$$\alpha^2 = a^2 + \eta^2,$$

and it is obvious that  $y$  cannot be less than  $\eta$ . With this expression for  $\alpha$ , the mere form of the equation (2) shows that the curve has a vertex at the point  $y = \eta$ , and that it is symmetrical about the ordinate through that point.

We must remark, in passing, that this property of symmetry about an axis, at the extremity of which is a vertex, is common to groups of rays in all media in which the refractive index depends only on the distance from a particular plane:— the groups which possess it being those which either do not reach that plane, or pass through it more than once.

3. Let us now consider only rays which have vertices, and which pass through a particular point  $x = 0, y = b$ . Then if  $\xi$  be the  $x$ -coordinate of the vertex, equation (2) becomes

$$\xi = \sqrt{a^2 + \eta^2} \int_{\eta}^b \frac{dy}{\sqrt{y^2 - \eta^2}} \dots\dots\dots(3).$$

This is the equation of the *Locus of Vertices* of all rays (having vertices) which pass through the point 0, *b*. We may write it in the form

$$\xi = \sqrt{a^2 + \eta^2} \log \frac{b + \sqrt{b^2 - \eta^2}}{\eta} \dots\dots\dots (3).$$

To draw the corresponding curve we may construct, for different values of *b*, the set of curves

$$\xi' = \log \left( \frac{b}{\eta} + \sqrt{\frac{b^2}{\eta^2} - 1} \right) \dots\dots\dots (4),$$

or 
$$\frac{2b}{\eta} = e^{\xi} + e^{-\xi}.$$

The ordinates of these curves are proportional to the reciprocals of those of a common catenary.

Next construct, for the given value of *a*, the equilateral hyperbola whose equation is

$$\xi'' = \sqrt{a^2 + \eta^2}.$$

Then we have, at once, for any given value of  $\eta$ ,

$$\xi = \xi' \xi''.$$

For the purpose of carrying out this process we have tabulated as below, a few rough numerical values:—and by the help of these the curve (4) has been drawn, along with (3), in three forms; for *b* = 2*a*, *b* = 4*a*, and *b* = 6*a*. See fig. 2. In each case (4) is represented by a dotted curve, (3) by the corresponding full curve.

$\frac{\eta}{b}$	$\log \left( \frac{b}{\eta} + \sqrt{\frac{b^2}{\eta^2} - 1} \right)$	$\sqrt{1 - \frac{\eta^2}{b^2}}$	$\sqrt{\frac{1}{4} + \frac{\eta^2}{b^2}}$	(ratio)
0.0	$\infty$	1.0	0.5	0.5
0.05	3.69	0.99	0.51	0.51
0.1	2.99	0.99	0.51	0.51
0.2	2.29	0.98	0.54	0.55
0.3	1.87	0.95	0.58	0.61
0.4	1.57	0.92	0.64	0.70
0.5	1.32	0.87	0.71	0.82
0.6	1.10	0.8	0.78	0.97
0.7	0.89	0.71	0.86	1.20
0.8	0.69	0.6	0.94	1.56
0.9	0.47	0.44	1.03	2.36
1.0	0.0	0.0	1.12	$\infty$

4. Let us digress to consider what we learn, in any case, from the *form* of the *Locus of Vertices*.

It is obvious that if, instead of the special law of refractive index assumed in the preceding section, we had written quite generally

$$\mu^2 = f(y),$$

(3) would have become

$$\xi = f(\eta) \int_b^\eta \frac{dy}{\sqrt{f(y) - f(\eta)}} \dots\dots\dots(3'),$$

while (2) would have been (for rays passing through the point 0, b),

$$0 = x - \alpha \int_b^y \frac{dy}{\sqrt{f(y) - \alpha^2}} \dots\dots\dots(2').$$

The new *form* of (2') shows that, for a given value of *y*, *x* increases with increase of  $\alpha$ ; provided no vertex is reached. For the denominator of the differential is less, and the integral is multiplied by a greater factor, than before. Hence two contiguous rays from the same point cannot again intersect till one, at least, has passed its vertex. When the vertex is included within the limits of integration, (2') may by the symmetry of the ray be written

$$0 = x - \alpha \int_b^y \frac{dy}{\sqrt{f(y) - \alpha^2}} - 2\alpha \int_y^\eta \frac{dy}{\sqrt{f(y) - \alpha^2}}, \text{ or } 0 = x + \alpha \int_b^y \frac{dy}{\sqrt{f(y) - \alpha^2}} - 2\xi.$$

Now the middle term (as we have seen) is positive, and increases with  $\alpha$ , if  $y > b$ . Hence the second intersection of the rays which have the common point 0, b, is at a point where  $y > b$ , if and only if,  $\xi$  increases as  $\alpha$  increases; *i.e.*, if the line, drawn from the vertex of the ray nearer to the minimum plane to that of the other, leans back towards the first common point of the two rays. The converse is easily seen to hold, by taking the second point of intersection as the starting-point and reversing the rays. Hence, if the minimum stratum be horizontal, two neighbouring rays, issuing from a common point below it, and originally directed above the horizon, intersect again *before* they have got back to the level of their former intersection, if their vertices be at a part of the curve of vertices where the tangent leans backwards over the starting-point, and *vice versa*. This proposition is, in fact, obvious from a mere inspection of the diagram fig. 3, in which the dotted curve is that of vertices, the eye being at *E*.

To apply it to the case of phenomena such as those observed by Vince and Scoresby, suppose the strata of equal refractive index to be horizontal. Then two rays slightly inclined to one another, leaving any point in a common vertical plane, will in general intersect one another before they again reach the level of the starting-point, if, and not unless, the vertex of the higher ray be *horizontally* nearer to the starting-point than that of the lower ray; *i.e.*, if the part of the curve of vertices concerned leans *towards* the starting-point. Also, as is well known, when two rays slightly inclined to one another, cross *once* between the eye and the object, the image formed is an inverted one.

5. Hence the following graphical method for finding the number and characters of the images of an object situated at the level of the eye. Trace the curve of vertices for all rays leaving the eye in the vertical plane containing the object. Draw also a vertical line midway between the eye and the object. The intersections of this line with the curve of vertices are the vertices of all the paths by which the object can be seen, when the eye is in the assigned position. Or, what comes to the same thing, but (unlike the simpler construction) admits of application to an object at *any* level, draw the curve of the vertices as before, and then draw another for an eye placed *at the object*. Their intersections determine the vertices of the rays giving all possible images.

It is easy to see that, at the intersections with the vertical line midway between eye and object, the curve of vertices, if continuous, must alternately lean from, and towards, the eye, *i.e.*, the images seen are alternately erect and inverted; their number depends of course upon the form of the curve of vertices; which, in its turn, depends not only upon the law of refractive index in terms of level, but also upon the position of the eye. [This alternation of images does not necessarily hold when eye and object are at different levels.]

Thus, as has long been known, the vertices of all the coplanar paths in which a projectile, fired with a given velocity, can move, with different elevations of the piece, lie in an ellipse whose major axis (double the minor axis) is horizontal. The lower half of this ellipse leans *from* the gun, the upper half *towards* it, and these correspond to angles of elevation of the piece, respectively less and greater than  $45^\circ$ . In the former case (when the elevation is less than  $45^\circ$ ), a slight increase of elevation increases the range on a horizontal plane, so that the new path is wholly above the old one; which, however, would intersect it *under* the horizon. In the latter case a slight increase of elevation shortens the range, so that the two paths must intersect before reaching the ground.

6. Recurring to the imagined medium in which

$$\mu^2 = a^2 + y^2,$$

we see by fig. 3 the paths of the rays by which the three images of  $AB$  are seen by an eye placed at  $E$ . This figure, as already remarked, is (with the exception of the introduction of the curve of vertices) almost identical with that of Vince in the *Phil. Trans.* for 1799.

But it is easy to see that, although this shows the possibility of three images in the relative positions observed by Vince, it is in no way capable of explaining his observation. For the existence of three images, in such a medium, requires (as I have found by an approximate method)\* that  $b$  be *at least*  $= 3.68a$ . Hence the

\* When  $\frac{d\xi}{d\eta} = 0$ , we have  $1 + \frac{a^2}{\eta^2} = \sqrt{1 - \frac{\eta^2}{b^2}} \log \left( \frac{b}{\eta} + \sqrt{\frac{b^2}{\eta^2} - 1} \right)$ . Plotting the curves whose ordinates (in terms of  $\eta$ ) are expressed by these two quantities, we find that they *touch* when  $b = 3.68a$ .



refractive index at the level of the eye ( $\sqrt{a^2 + b^2}$ ) must be at least 3.8 times that in the minimum stratum. And the distance at which an object on the horizon requires to be situated, in order that there may be three images of it, lies within exceedingly narrow limits, unless the refractive index at the level of the eye very greatly exceed this lowest admissible value.

7. The possibility of three images of an object at the level of the eye evidently depends on the existence of three values of  $y$ , for the same value of  $x$ , in the curve of vertices. It is therefore necessary that we should study the question from this point of view.

On thinking of the relative forms of the curves of vertices in fig. 2; the first of which gives only one image, the second and third (in certain cases) three:—I saw that the point of inflexion, on which the triple value of  $y$  depends, is due to the gradual diminution of curvature of the ray near the eye (for rays of a given inclination to the vertical) as the eye is placed lower in the medium. Hence any arrangement which lessens the curvature of the lower parts of the rays will increase this effect.

In fact, the portion  $ABC$  of the ray  $OB$  (fig. 4) is congruent with the ray  $abc$ , if only the tangents at  $A$  and  $a$  be parallel. Hence the point  $B$  would be shifted to  $b$  if the ray  $Oa$  were straight (or at all events, less curved than  $OA$ ) and the angle at  $a$  equal to that at  $A$ .

Thus it was at once obvious that the curve of vertices (fig. 5) in the stratum above  $RS$ , might be made asymptotic to that line towards the right of the figure (the eye being still at  $O$ ), if only the stratum below it were of uniform refractive index, or at least of a refractive index diminishing so slowly with increased height that a ray from  $O$  could intersect  $RS$  at a practically infinite distance. This at once showed me the general nature of one mode of explanation. The curve of vertices  $QPQ'$  in the stratum  $RU$  will now be asymptotic, towards the right, to both  $RS$  and  $TU$ , and therefore can be cut in *two* points by a sufficiently distant vertical. These points correspond to Vince's two upper images, the third and lowest is seen by rays which have not reached the upper stratum, and for which the corresponding branch of the curve of vertices is the horizontal line  $OM$ , passing through the eye.

8. To repeat:—the conditions requisite for the production of Vince's phenomenon, at least in the way conjectured by him, are, a stratum in which the refractive index diminishes upwards to a minimum (or, at all events, nearly to a stationary state); and, below it, a stratum in which the upward diminution is either considerably less or vanishes altogether. The former condition (the fall to a nearly stationary state) secures the upper erect image, the latter the inverted image. When the former is not present, we have the phenomenon so often observed and figured by Scoresby. This requires merely a change from a slowly diminishing refractive index to a more quickly diminishing one, and may occur simultaneously in more than one horizontal layer. Turned upside down, this arrangement gives the ordinary mirage of the desert.

When this condition is not present, but only the stationary state, we have Vince's upper erect image without the inverted one. This is figured several times by Scoresby.

9. If, instead of a plane of minimum, we have a plane of maximum, refractive index, we may assume

$$\mu^2 = a^2 - y^2.$$

An investigation precisely similar to the preceding gives for a ray passing through 0,  $b$  the equation

$$x = \sqrt{a^2 - \eta^2} \left( \sin^{-1} \frac{y}{\eta} - \sin^{-1} \frac{b}{\eta} \right).$$

Each ray therefore is a harmonic curve, whose level line is in the maximum stratum, and which passes through that stratum an infinite number of times. The locus of vertices is

$$\xi = \sqrt{a^2 - \eta^2} \left( \cos^{-1} \frac{b}{\eta} + n\pi \right).$$

Here  $\eta$  is to be taken positive when  $n$  (any integer) is even, and negative when it is odd.

The following rough table suffices to determine the general form of this curve in the particular case  $a = 5b$ . It is shown in fig. 6; and it has been foreshortened for convenience of representation.

$\frac{b}{\eta}$	$\frac{2}{\pi} \cos^{-1} \frac{b}{\eta}$	$\frac{\xi}{b}$	
			$n = 0$
1.0	0.0	$\pm 0.0$	$n = 1$
0.95	0.2	$\pm 0.98$	9.8      9.8
0.9	0.29	$\pm 1.39$	8.8      10.76
0.8	0.41	$\pm 1.98$	8.35      11.13
0.7	0.51	$\pm 2.42$	7.70      11.66
0.6	0.59	$\pm 2.78$	7.16      12.0
0.5	0.67	$\pm 3.05$	6.64      12.2
0.4	0.74	$\pm 3.20$	6.11      12.21
0.3	0.80	$\pm 2.97$	5.46      11.86
0.25	0.84	$\pm 1.9$	4.47      10.41
0.2	0.87	0.0	2.5      6.3
0.1	0.93	...	0.0      0.0
0.0	1.00	...	...      ...

The general problem of determining the images is, in this case, a very complicated, though not difficult, one; but it becomes much simplified if we assume as before the object and eye to be at the same level. It is obvious that a vertical line, midway between the eye and the object, will cut the curve of vertices an

infinite number of times, both above and below the maximum stratum. Thus there is in such a case an infinite number of images, which are seen by rays which have crossed the maximum stratum an even number of times, in which zero may be included. These must each have one, or some other *odd* number, of vertices between the eye and the object, and the horizontal distance between two such vertices is

$$\pi\sqrt{a^2 - \eta^2},$$

which is therefore less for that one of two rays which intersects the maximum plane at the greater angle.

In nature, of course, the number of images depending on a law like this must always be finite, because the utmost percentage change of refractive index in the lower atmosphere is very small. But, independent of equilibrium considerations, there is the farther objection that it cannot be reconciled with the appearances seen by Vince and Scoresby. For these were, in the main, very similar to one another for all distances of the object beyond certain limits; while with the present assumption, the appearances presented by an object moving to successively greater distances would exhibit a species of *quasi periodic* change which I have nowhere seen described. And, if we keep to probable changes in the refractive index of the atmosphere, this law will give only one image:—not, of course, in the true direction of the object:—but erect, and therefore not properly coming under the designation of “mirage.”

10. After trying a number of assumptions as to the law of refractive index in the transition stratum, I finally chose for detailed examination the following:—

$$\mu^2 = a^2 + e^2 \cos \frac{\pi y}{b}.$$

This seemed to me particularly worthy of investigation, for it must be at least a fair approximation to the state of matters near the common boundary of two inter-diffusing fluids, or of two masses of the same fluid at different temperatures. This follows from the facts that:—it gives a stationary state at  $y=0$ , with a maximum refractive index; and another at  $y=b$ , with a minimum index. Near  $y=\frac{b}{2}$  there is a stratum of greatest rapidity of change of index. This hypothesis has also the advantage of leading to equations which can be treated by the ordinary elliptic integrals.

With this law it follows that, if the eye be in the plane  $y=0$ , the equation of the curve of vertices is

$$\begin{aligned} e\xi &= \sqrt{a^2 + e^2 \cos \frac{\pi\eta}{b}} \int_0^\eta \frac{dy}{\sqrt{\cos \frac{\pi y}{b} - \cos \frac{\pi\eta}{b}}} \\ &= \frac{\sqrt{2} \cdot b}{\pi} \sqrt{a^2 + e^2 \cos \frac{\pi\eta}{b}} F_1 \left( \sin \frac{\pi\eta}{2b} \right). \end{aligned}$$

The equation of the path of a ray is

$$ex = \sqrt{a^2 + e^2 \cos \frac{\pi\eta}{b}} \int_0^y \frac{dy}{\sqrt{\cos \frac{\pi y}{b} - \cos \frac{\pi\eta}{b}}} \\ = \frac{\sqrt{2} \cdot b}{\pi} \sqrt{a^2 + e^2 \cos \frac{\pi\eta}{b}} F\left(\sin \frac{\pi y}{2b}, \phi\right)$$

where  $\sin \frac{\pi y}{2b} = \sin \frac{\pi\eta}{2b} \sin \phi$ .

We have also

$$\frac{dy}{dx} = e \frac{\sqrt{\cos \frac{\pi y}{b} - \cos \frac{\pi\eta}{b}}}{\sqrt{a^2 + e^2 \cos \frac{\pi\eta}{b}}}$$

and, for  $y = 0$ , this takes the value

$$\frac{\sqrt{2} \cdot e \sin \frac{\pi\eta}{2b}}{\sqrt{a^2 + e^2 \cos \frac{\pi\eta}{b}}}$$

For the application of these formulæ the following little table has been prepared:—

$\frac{\eta}{b}$	$\frac{1}{k} = \operatorname{cosec} \frac{\pi\eta}{2b}$	$F_1(k)$	$\frac{E_1(k)}{1-k^2}$
0.0	$\infty$	$\pi/2$	$\pi/2$
0.1	6.39	1.58	1.60
0.2	3.24	1.61	1.69
0.3	2.20	1.66	1.87
0.4	1.70	1.74	2.18
0.5	1.41	1.85	2.70
0.6	1.24	2.01	3.67
0.7	1.12	2.24	5.74
0.8	1.05	2.60	11.53
0.9	1.012	3.26	42.24
0.95	1.003	3.94	164.17
0.975	1.00077	4.62	650.85
1.0	1.000	$\infty$	$\infty$

The headings explain themselves. The last column is required, as will soon be seen, for the determination of the *magnitudes* of the images, as compared with that of the object when seen (at its true distance) through uniform air.

11. Let us now extend the formulæ of § 4 to the case of a stratum of depth  $c$ , in which the refractive index is constant ( $=\sqrt{f(c)}$ ); surmounted by another of thickness  $b$ , in which the index is  $\sqrt{f(y)}$ .

The equation of a ray, passing from the origin, which we now take in the lower surface of the inferior stratum, is

$$x = \alpha \int_0^y \frac{dy}{\sqrt{f(y) - \alpha^2}}.$$

While  $y$  is not greater than  $c$ , this is the straight line

$$x = \frac{\alpha y}{\sqrt{f(c) - \alpha^2}}.$$

But when  $y$  is greater than  $c$ , we have

$$x = \frac{\alpha c}{\sqrt{f(c) - \alpha^2}} + \alpha \int_c^y \frac{dy}{\sqrt{f(y) - \alpha^2}} \dots\dots\dots(2'').$$

Also, for the branch of the curve of vertices which is in the upper stratum (the other branch being, of course, the axis of  $x$ ),

$$\xi = \frac{c \sqrt{f(\eta)}}{\sqrt{f(c) - f(\eta)}} + \sqrt{f(\eta)} \int_c^\eta \frac{dy}{\sqrt{f(y) - f(\eta)}} \dots\dots\dots(3'').$$

Fig. 5 has been roughly traced from this formula and the curve of fig. 2.

12. In the next following equations, recurring to the form

$$\mu^2 = a^2 + e^2 \cos \frac{\pi y}{b},$$

we will simplify matters by making  $a=1$ , and altogether neglecting the terms in  $e^2$  when they are added to others not containing  $e$ . This will be fully justified, so far as air is concerned, in a subsequent section.

By §§ 10, 11 the equation of the curve of vertices is

$$e\xi = \frac{c}{\sqrt{2}} \operatorname{cosec} \frac{\pi\eta}{2b} + \frac{b\sqrt{2}}{\pi} \int_0^{\frac{\pi}{2}} \frac{d\phi}{\sqrt{1 - \sin^2 \frac{\pi\eta}{2b} \sin^2 \phi}}.$$

If we write

$$k = \sin \frac{\pi\eta}{2b} = \frac{\tan \theta}{\sqrt{2} \cdot e},$$

where  $\theta$  is the inclination of the straight part of the ray, this becomes

$$e\xi = \frac{c}{\sqrt{2} \cdot \pi} \left\{ \frac{\pi}{k} + \frac{2b}{c} F_1(k) \right\} = \frac{c}{\sqrt{2} \cdot \pi} \mathfrak{F}.$$

Differentiating, and eliminating  $\delta k$ , remembering that  $\theta$  is always very small (so that  $\sec \theta = 1$  practically), we have

$$\begin{aligned} e \frac{\delta \xi}{\delta \theta} &= -\frac{c}{2\pi ek} \left\{ \frac{\pi}{k} + \frac{2b}{c} F_1(k) - \frac{2b}{c} \frac{E_1(k)}{1-k^2} \right\} \\ &= -\frac{c}{2\pi ek} \left\{ \mathfrak{F} - \frac{2b}{c} \mathfrak{E} \right\}. \end{aligned}$$

By means of these expressions we can easily calculate the relative apparent vertical heights of the various images.

For, if there be a small object, of height  $h$ , at a distance  $2\xi$  in a horizontal direction, it will be seen *direct* (through the stratum of uniform density) under the angle

$$\frac{h}{2\xi}.$$

But the image is obviously seen under the angle  $\delta\theta$ , corresponding to rays which, leaving the eye, pass through its upper and lower points. If  $2(\xi + \delta\xi)$  be the range of the ray through the upper point of the object, we obviously have (to a sufficient approximation),

$$h = 2\delta\xi \tan \theta = 2\sqrt{2} \cdot ek\delta\xi;$$

and thus we find

$$\delta\theta = \frac{h}{2\sqrt{2} \cdot ek \frac{d\xi}{d\theta}}.$$

Hence the ratio, of the apparent altitude of the image to that of the object as seen directly, is

$$\frac{\xi}{\sqrt{2} \cdot ek \frac{d\xi}{d\theta}} = -\frac{\mathfrak{F}}{\mathfrak{F} - \frac{2b}{c} \mathfrak{E}} = \mathfrak{G}.$$

In passing, we observe that, as it is easy to see, the multiplier of  $h$  in the above expression for  $\delta\theta$  represents the divergence or convergence of the pencil which reaches the eye from a point of the image. It expresses convergence when its value is positive.

13. Let the value of  $\xi$  be given,  $a$  suppose; then we have, to determine  $k$ , the equation

$$\sqrt{2} \cdot \pi e \frac{a}{c} = \mathfrak{F}.$$

The short table (§ 15) which follows shows that this equation gives two real values of  $k$  (say  $k_1$  and  $k_2$ ) for all values of  $a$  exceeding a certain limit. For the quantity  $\mathfrak{F}$  is infinite alike for  $\eta=0$  and for  $\eta=b$ , and has one minimum only. The angular separation of the two corresponding images of a point on the horizon is

$$\sqrt{2} \cdot e(k_1 - k_2).$$

This quantity must obviously become less as the object approaches the spectator, for the values of  $k$  become more nearly equal. Its utmost value is  $\sqrt{2} \cdot e$ .

14. If the object be now raised above the horizon, let its coordinates be  $2a, h$ ; then for either of the rays which pass through an image

$$2a = 2\xi - h \cot \theta,$$

or

$$2a = 2\xi - \frac{h}{\sqrt{2} \cdot ek},$$

$$= \frac{\sqrt{2} \cdot c}{\pi e} \mathfrak{F} - \frac{h}{\sqrt{2} \cdot ek}.$$

By the process of § 13, above, we find that the ratio of the apparent heights of the image and object is now

$$\frac{\mathfrak{F} - \frac{\pi h}{2kc}}{\mathfrak{F} - \frac{\pi h}{2kc} - \frac{2b}{c} \mathfrak{E}},$$

which agrees with the former result when  $h=0$ .

By a well-known optical theorem, the result would have been the same if the object had been left where it was, and the eye had been elevated through a height  $h$ .

It is well to observe here that, as the eye and object are not now on the same horizontal line, we can no longer conclude without special investigation that only three images will be produced. But this opens up a new question, somewhat more complex than those with which we are engaged. I may recur to it on some other occasion. For the present I confine myself to repeating the remark, that if we draw the curve of vertices as before, and in addition draw that corresponding to an eye placed *at the object*, the intersections of these two curves give all the possible vertices. This is the obvious modification which the process requires, when the eye and object are not at the same level. In the present case, we see at once by this process that no new images come in.

15. The following numerical values have been calculated for the purpose of

illustrating these formulæ. The symbols employed are the same as in the analysis above:—

$\frac{\eta}{b}$	$b = 10c$		$b = c$		$b = \frac{c}{10}$		$b = \frac{c}{100}$	
	$\mathfrak{F}$	$\mathfrak{G}$	$\mathfrak{F}$	$\mathfrak{G}$	$\mathfrak{F}$	$\mathfrak{G}$	$\mathfrak{F}$	$\mathfrak{G}$
0.0	$\infty$	- 1	$\infty$	- 1.0	$\infty$	- 1.0	$\infty$	- 1.0
0.1	51.7	- 2.63	23.24	- 1.16	20.40	- 1.02	20.11	- 1.0
0.2	42.4	- 4.99	13.39	- 1.34	10.49	- 1.03	10.20	- 1.0
0.3	40.2	- 14.73	10.25	- 1.58	7.25	- 1.05	6.95	- 1.01
0.4	40.2	+ 11.95	8.83	- 1.97	5.69	- 1.08	5.38	- 1.01
0.5	41.5	+ 3.32	8.15	- 2.97	4.81	- 1.13	4.48	- 1.01
0.6	44.1	+ 1.51	7.91	- 13.91	4.29	- 1.21	3.92	- 1.02
0.7	48.4	+ 0.73	8.01	+ 2.31	3.97	- 1.41	3.57	- 1.03
0.8	55.3	+ 0.32	8.50	+ 0.58	3.82	- 2.52	3.36	- 1.07
0.9	68.3	+ 0.09	9.69	+ 0.13	3.83	+ 0.83	3.25	- 1.35
0.95	81.9	+ 0.026	11.02	+ 0.03	3.94	+ 0.14	3.23	+ 60.59
0.975	95.6	+ 0.007	12.39	+ 0.01	4.07	+ 0.03	3.24	+ 0.33
1.0	$\infty$	0.0	$\infty$	+ 0.0	$\infty$	+ 0.0	$\infty$	+ 0.0

16. We must now consider, so far as is necessary, the physical properties of air:—and observations which have been made as to actual changes of temperature at different elevations above the earth's surface. There is no necessity for dealing with very exact physical data, because we must make assumptions as to distribution of temperature which cannot, at the best, be more than rough approximations. All that we can attempt to show is, that the observed phenomena are of a character and on a scale compatible with the known properties of air, with observed changes of temperature in the atmosphere, and with the arrangement we have suggested for the production of these phenomena.

Thus, although aqueous vapour diminishes the refractive index of air, the practical effect is so minute at its utmost that we neglect it:—a very slight change in our assumption as to temperature would be sufficient to make up for it.

Assume, then, for air at 0° C. and 760 mm.,

$$\mu_0 = 1.000294 = 1 + \frac{1}{3400}.$$

Assume farther, what is only approximately true, that the refractive power depends on the density alone, and is proportional to it:—*i.e.*,

$$\mu = 1 + \frac{1}{3400} \frac{\rho}{\rho_0}.$$

The next assumption:—that the air is practically in hydrostatic equilibrium, when



such phenomena are observed:—is probably not far from the truth, except in the case of the mirage of the desert. It gives

$$\frac{dp}{dy} = -g\rho;$$

or, with the laws of Boyle and Charles,

$$R \frac{d(\rho t)}{dy} = -g\rho.$$

Now if  $H = 26,000$  feet, be the “height of the homogeneous atmosphere,” we have

$$p_0 = R\rho_0 t_0 = g\rho_0 H,$$

so that the hydrostatic equation becomes

$$\frac{1}{t_0} \frac{d(\rho t)}{dy} = -\frac{\rho}{H};$$

or, to a sufficient approximation,

$$\frac{1}{t_0} \frac{dt}{dy} = -\frac{1}{H} - \frac{1}{\rho_0} \frac{d\rho}{dy}.$$

Instability occurs when  $\frac{d\rho}{dy}$  is positive. Hence the greatest rate of fall of temperature, per foot of ascent, which is consistent with stability is

$$\frac{dt}{dy} = -\frac{t_0}{H} = -\frac{274^\circ}{26,000} \text{ C.},$$

or  $-1^\circ 05$  C. per hundred feet.

Glaisher\*, in a captive balloon, on two occasions out of twenty-seven, observed the fall of temperature in the first hundred feet to be  $1^\circ 8$  F. and  $1^\circ 9$  F. respectively. On other three of these occasions it was  $1^\circ 7$  F.,  $1^\circ 5$  F. and  $1^\circ 3$  F. respectively. The first two correspond almost exactly to the  $1^\circ 05$  C. above computed for a stratum of uniform refractive index. The temperature near the earth's surface was on these occasions  $73^\circ 6$  F. and  $76^\circ 2$  F.; or, roughly  $24^\circ$  C. The greatest rise of temperature per 100 feet of ascent, which he observed on any of these twenty-seven occasions was  $0^\circ 3$  F. only. It seems from what follows, therefore, that on none of these occasions would Vince's phenomena have been possible.

17. To fix the ideas, let us now assume that the first 50 feet of air is of uniform density, and that next there is a stratum of 50 feet thick in which the refractive index is given by

$$\mu^2 = a^2 + e^2 \cos \frac{\pi(y-50)}{50},$$

\* B. A. Report, 1869, p. 37.

$y$  being measured from the surface of the earth. Since we may look on  $\mu$  as practically unity, we have by the formulæ above

$$\frac{1}{\mu} \frac{d\mu}{dy} = \frac{1}{3400} \frac{1}{\rho_0} \frac{d\rho}{dy} = -\frac{1}{3400} \left( \frac{1}{H} + \frac{1}{t_0} \frac{dt}{dy} \right).$$

Hence, by our assumed law of refractive index,

$$\frac{1}{H} + \frac{1}{t_0} \frac{dt}{dy} = \frac{3400}{2} \frac{\pi e^2}{50} \sin \frac{\pi(y-50)}{50}.$$

Hence the greatest rate of change of temperature per foot of ascent (at  $y = 75$  feet) is

$$274 \times 34\pi e^2 - 0.0105.$$

The whole change of temperature, from the bottom to the top of the stratum, is

$$274 \times 3400e^2 - 0.53.$$

Both of these quantities are in degrees centigrade.

18. To get an idea of the magnitude of  $e^2$ , we note that, by Scoresby's observations, the elevation of the images above the horizon is usually about 10 or 15 minutes of arc at the utmost. Hence, by the value of  $\frac{dy}{dx}$  in § 10, we may assume as an upper limit,

$$\sqrt{2} \cdot e = \frac{1}{250},$$

or

$$e^2 = 0.000008.$$

With this, the greatest rate of rise of temperature in the assumed stratum is  $0^\circ.22$  C. per foot of ascent, and the whole rise is about  $6^\circ.9$  C. These quantities, moderate as they are, would be greatly diminished by our relinquishing the assumption that the density in the lower stratum is constant.

But even this indicated rise of temperature with elevation has been actually observed. Thus Glaisher\* gives, for July 17th, 1862,

Time.	Altitude.	Temperature.	By Gridiron Thermometer.
10.30 A.M.	19,415 feet	38°·1 F.	38°·1 F.
10.35 A.M.	19,435 feet	43°·0 F.	42°·2 F.
10.39 A.M.	19,380 feet	37°·0 F.	36°·5 F.

The greatest difference here observed is as much as  $5^\circ$  F. in 20 feet; *i.e.*, at the rate of  $12^\circ.5$  F. or  $7^\circ$  C. per 50 feet, precisely what is required above.

\* *B. A. Report*, 1862.

19. We have another and independent mode of testing whether this value of  $e$  accords with observation. For Scoresby tells us that, only on rare occasions and then only slightly, were objects at four miles' distance affected. The usual distance was 10 to 15 miles. Now, by the table in § 15 we see that the nearest object of which an image can be formed is distant

$$\frac{50\sqrt{2}}{\pi e} 7.9 \text{ feet;}$$

or, with the above value of  $e$ , about 12 miles.

There is thus a fair agreement, so far at least as these tests can tell us, between the results of our hypothesis and observation.

The table in § 15 shows that, with the same value of  $e$ , and the same thickness of the lower stratum, as before, but with the assumption of a transition stratum of a thickness of five feet only; the distance of the nearest object of which an image could be formed would be about six miles only. A still farther reduction of the thickness of the transition stratum reduces this least distance still farther; but it is clear from the table that there is a limit somewhere about five miles. This would be still farther reduced if we supposed the lower uniform stratum to have a depth of less than 50 feet. On the other hand, we see that an increase of thickness of the transition stratum introduces distances greater than are consistent with observation; unless, indeed, the thickness of the lower stratum be at the same time reduced. In the table  $\mathfrak{f}$  and  $\mathfrak{G}$  depend upon the ratio of  $b$  to  $c$ ;  $\xi$  is proportional to  $c$ .

20. The columns headed  $\mathfrak{G}$  in the table of § 15 give, as shown in § 12, the magnitudes of the images relative to that of the object seen directly. They show that the inverted image is always taller than the object. This is consistent with Scoresby's observations. When the object is not near the critical distance, however, this magnification is not considerable:—even if we assume a 50-foot transition stratum. On the other hand, the erect image, except when the object is not far beyond the critical distance, is much smaller than the object. Moreover, as is obvious from §§ 12, 15, this image is seen by *converging* rays. No doubt they are so nearly parallel as to be capable of producing distinct vision in a normal eye; but the remark is necessary as showing how different, in some respects, is the phenomenon from one of Wollaston's imitations of it. Both images become infinite:—*i.e.*, there is simply "looming":—when the object is situated at the critical distance. And, as the tables show from the result of § 13, the ratio of the distance between the images to the apparent size of the object seen directly, increases as the object recedes beyond the critical distance. All this seems to accord completely with Vince's and Scoresby's observations. The only additional remark I need make is that possibly Scoresby, from insufficient telescopic power, failed to see (or at least to recognise as part of the phenomenon) the upper erect image, when the object was much beyond the critical distance. The table shows the great rapidity with which its height

diminishes as the object recedes. The disparity between the images depends of course upon the fact that we have assumed a law which places the plane of most rapid change in the middle of the stratum. This may often not be the case in nature. It might be useful to work out the whole again, assuming a law (for the transition stratum) which would place the plane of most rapid change considerably out of the middle of the stratum. But I cannot attempt this at present. The results of § 14 seem also to be in complete accord with Scoresby's observations at Bridlington Quay, which are the only detailed ones I have met with in which the point of view was shifted to or from the transition stratum.

21. For an approximate estimate of the effect of the earth's curvature on these phenomena, let us suppose the same law of density as before; but let the strata be now *level*, *i.e.*, spheres concentric with the earth. The path of a ray in the lower stratum will still be straight, but the angle at which it meets the transition stratum ( $\theta + \psi$ , suppose) will now be necessarily greater than its original inclination ( $\theta$ ) to the horizon. See fig. 7.

If  $R$  be the radius of the earth, we find to a sufficient approximation,

$$(R + c) \cos \psi - R = R\psi\theta,$$

or

$$\theta = \frac{c}{R\psi} - \frac{\psi}{2}.$$

As  $\theta$  cannot be negative, the greatest value of  $\psi$  is

$$\sqrt{\frac{2c}{R}} = \frac{1}{460}$$

nearly;  $c$  being 50 feet, as before. If we write  $\frac{1}{p}$  for this quantity, we have

$$2p\theta = \frac{1}{p\psi} - p\psi,$$

whence, by giving  $p\psi$  the values 1, 0.9, 0.8, &c., we easily obtain the following table:—

$\theta$	$\theta + \psi$
0.0000	0.0022
0.0002	0.0022
0.0005	0.0022
0.0008	0.0023
0.0012	0.0025
0.0016	0.0027
0.0023	0.0032
0.0033	0.0040
0.0053	0.0057
0.0110	0.0112

Now if we take the value of  $e$  as in § 18, we have 0.004 for the greatest value of  $\theta + \psi$ , which is consistent with the rays not passing *through* the transition stratum. This corresponds to

$$\theta = 0.0033 = \frac{1}{300} = 12' \text{ nearly.}$$

Hence, with this value of  $e$ , other assumptions remaining the same, even the upper erect image could not (on account of the earth's curvature) be elevated more than about 12' above the horizon, and the nearest object of which multiple images could be formed would be at a distance of about 13 miles. Greater values of  $e$  might remove this difficulty, but they would introduce greater changes of temperature. This shows, therefore, that the assumption of a lower stratum of uniform density is untenable. If there is to be a *simple* arrangement in that stratum, it must therefore be such that the refractive index diminishes with elevation, but, of course, less rapidly than in the lower half of the transition stratum. The effect of this would be to slightly raise the images, and to reduce the critical distance.

Instead of the upper image, consider the lower one. This would be, at its *farthest*, within the distance of the visible horizon as seen from an elevation of 50 feet. Hence no inverted image of the hull of a vessel could be seen if it were more than 18 miles distant; and even then it would be seen horizontally. The only ways of reconciling this with Scoresby's observations are (1) to assume that the lower uniform stratum is much more than 50 feet thick; (2) to assume that it is not uniform, but gives rays a concavity downwards. The former alternative is inadmissible on several of the grounds already mentioned; so we are again forced to assume the latter, which certainly holds if the temperature throughout the lower stratum be constant.

22. In order that the above calculations may be applicable to the phenomena shown by inter-diffusing solutions, it is necessary that the length of the vessel in which the solutions are contained be great enough to allow all rays (by which the images are seen) to enter and escape from the transition stratum by one of its horizontal surfaces, and not by its ends. By using a vessel nearly 4 feet long, containing a layer of weak brine diffusing into pure water above, I have verified the general accuracy of the results just given. For those rays which enter or escape by an end, the calculation is by no means so simple, and trial shows that the law determining the relative magnitudes of the images is considerably modified. On the other hand, when the vessel is so short and the rays so nearly horizontal, that each ray, while passing through the vessel, may be supposed practically to move in a stratum of uniform rate of change of refractive index, a very simple calculation suffices to give the general nature of the phenomena produced. For the curvature of a ray, in the vessel, may now be regarded as constant throughout. Here

J. Thomson's formula\* is immediately and usefully applicable. For, if  $\theta_1, -\theta_2$ , be the angles the ray makes with the horizon just after entering and just before escaping, we have

$$\theta_1 + \theta_2 = -\frac{t}{\mu} \frac{d\mu}{dy},$$

where  $t$  is the length of the vessel. But, if  $\theta'_1, -\theta'_2$ , be its directions before entering and after escaping, we have approximately,

$$\theta'_1 = \mu\theta_1, \quad \theta'_2 = \mu\theta_2.$$

Thus the whole change of direction is

$$\theta'_1 + \theta'_2 = -t \frac{d\mu}{dy},$$

depending only on the rate of change, not on the value, of the refractive index. Parallel rays, passing nearly horizontally through such a vessel, will all be bent in the direction in which the refractive index increases:—but that which passes through the stratum of most rapid change of index will be the most bent, so that the illuminated portion of a sufficiently distant screen on which the rays fall will be terminated by a spectral band of which the violet is outermost. Measurements of the position of this band, from day to day, from hour to hour, or even (in some cases) from minute to minute, will give an extremely accurate mode of measuring the rate of diffusion. To interpret their indications, however, a determination must be made of the law which connects the refractive index of a mixture of the two fluids with the relative proportions in which they are mixed. And it may not always, or even usually, be the case that the stratum of greatest rapidity of change of refractive index is necessarily coincident with that of most rapid diffusion. From the former, however, the latter can always be found; and, so long as the original layers of the fluids remain in part unaltered by the diffusion, the knowledge of the plane and rate of greatest diffusion is sufficient for the complete determination of the other circumstances. I believe that many important questions connected with diffusion may be speedily and accurately investigated by this very simple method. I propose to give a detailed account of it, with experimental results, to the Society on a future occasion.

23. In order to calculate roughly the number, position, and dimensions of the images visible to an eye looking through the media nearly horizontally at a distant

\* *B. A. Report*, 1870. Thomson finds by a simple process, for the curvature of a ray in a non-homogeneous medium, the expression

$$\frac{1}{\rho} = \frac{1}{\mu} \frac{d\mu}{dn},$$

where  $n$  is measured towards the centre of curvature. The result is seen to follow immediately from the corpuscular theory (in which  $\mu = v$ ) by multiplying both sides by  $\mu^2$ , for it is thus found to be merely the equation of acceleration of a corpuscle in the direction perpendicular to its path. It is really involved in Prop. I. of Wollaston's paper (*Phil. Trans.*, 1800).

object, all that is necessary is to draw the caustic, as in fig. 8. It consists, so far as the transition stratum is concerned, of the two (practically) equal and similar curves  $AB$ ,  $A'B'$ ; which touch the stratum above and below, and have as common asymptote the path of the most deflected ray. So long as the eye is not within the region  $BAC$ , only one image is seen. But from any point within this region two tangents can be drawn to the caustic, and a line can be drawn to the object so as to pass altogether below the stratum. Thus there are three images. In order that the middle one may be distinctly visible, the eye must be 10 inches or so beyond the point of contact of the corresponding ray with the lower caustic. Then the image is an inverted one. The others are always direct. [It may be remarked, in passing, that the intersection of the ray  $AC$  with the screen is always definite and measurable.]

Here the upper image is always seen by diverging rays, the middle one by diverging or converging rays according to the position of the eye. Contrast this with the results given in § 20. This middle image changes its direction far more rapidly than the others when the eye is moved vertically. It coincides with the upper image when the eye, gradually moved downwards, reaches the line  $DB$ . When they meet, both become blue and then disappear by moving the eye farther down. On moving the eye upwards, the middle image approaches the lower one, and they unite and disappear when the eye reaches the line  $DC$ . These results are easily verified by trial, and I have mentioned them only with the view of bearing out my statement, that this form of experiment, unless the tank be long enough, does not give results the same as those of Mirage.

(Read 19th June, 1882.)

A few days ago, while finally preparing the above pages for press, I had occasion once more to consult Wollaston's paper, and inadvertently took down the wrong volume of the *Phil. Trans.* In it (the vol. for 1803) I found another paper on Mirage by Wollaston, in which he speaks of certain articles by Woltmann and Gruber, and regrets his inability to read German. This led me to consult the *Register-band* of *Gilbert's Annalen*; and I thus learned the existence of a very elaborate memoir by Biot\* which I had never seen referred to, and in which the subject of mirage is exhaustively treated both by calculation and by long series of exact measurements of the phenomena as seen by Mathieu and Biot at Dunkirk, and by Arago and Biot at Majorca. The previous work of Gruber, Woltmann, Büsch, and others, is carefully summarised by Gilbert in vol. XI. of his *Annalen* (1802) in notes

\* *Mém. de l'Institut*, 1809; *Récherches sur les Réfractions extraordinaires qui ont lieu près de l'horizon*. I presume that my having been altogether ignorant of the existence of this memoir is connected with the fact that it is unintelligible without the plates, and that these were not issued along with it. For in each of the three first libraries which I consulted, that of the Society being one, this volume of the *Mém. de l'Institut* is devoid of plates. Biot's memoir, however, was issued also as a separate volume, and a copy of this, containing the plates, I procured at last from the Cambridge University Library.

to his translation of Wollaston's great paper of 1800. A good deal of Biot's work is thus seen to have been anticipated. It may be well to quote here Gilbert's remark as to the priority of explanation of some of these phenomena—think of it now as we may:—

“In der That ist Wollaston der Erste und Einzige, der die *Spiegelung aufwärts* mit Glück zu erklären unternommen hat, ob er gleich auch hierin noch sehr viel zu thun übrig lässt.”

Biot, on the other hand, gives Wollaston credit only for the physical, as distinguished from the mathematical, parts of his paper. He says:—

“Sous le rapport de la physique, son travail ne laisse rien à désirer.”

Biot has considered the subject from a point of view somewhat similar to that which I had adopted, and anticipated of course the great majority of the more general results at which I had arrived. I was occasionally almost startled as I looked through his memoir, to find how closely (even in mode of stating them) I had reproduced some of his main ideas. His whole treatment, for instance, of the ordinary mirage of the desert:—on the assumption that the square of the velocity of a luminous corpuscle is proportional to the height above the ground, but only through a limited stratum, together with the important effects of limitation of the stratum:—is almost the same as mine, except that he (inconveniently I think) uses the caustics in preference to the curve of vertices, though he also notices the latter as the *courbe des minima*. In consequence, I had all but made up my mind to withdraw my paper, before I had looked more than half-way through Biot's long memoir; for, though I found here and there statements which I think inaccurate, these are of very small consequence compared with the whole. But it was otherwise when I read farther, where Biot gives his tentative explanation of Vince's observation. There I found our assumptions to be so entirely different in character that, being fairly satisfied with my own, I thought I might still reasonably produce them with their results. My paper, therefore, appears as it was presented to the Society, except in so far as (*a*) a part of the introduction, (*b*) the detailed examination of the ordinary mirage of the desert, (*c*) a discussion of the singular outline sometimes presented by the setting sun, and (*d*) a few minor remarks, are concerned. These parts have been simply struck out, the first as historically imperfect, the others as practically a mere reproduction of what had already been satisfactorily done by Biot, who had many opportunities of observing and measuring the phenomena. As to the ordinary mirage, however, there can be no doubt that the discovery of the existence of *four* images, when the eye and object are both above the hot stratum, is far more easy by means of the curve of vertices than by the caustics employed by Biot.

I transcribe some of the more important parts of Biot's remarks on Vince's phenomenon, premising that it was of course impossible for him to have been acquainted with Scoresby's observations, at least at the time when his memoir was written. I fancy that, if he had seen these, he might have felt some doubts as to the accuracy of his inference that the rays, in their course to Vince's eye, were probably at first *concave upwards*; and this to such an extent as to make a vessel, which was situated close to the ordinary horizon, show only its top-masts above the apparent



horizon. He does not advert to the *certainty* that, had this law held over the nearer parts of the sea, Vince would have seen inverted images *under* ships within the visible horizon. None such are described. After quoting the passages in question, I shall add a few comments on them. To make them as intelligible as possible, I have reproduced Biot's hypothetical figure; it is numbered as fig. 9 in Plate XI. In many respects the following passages are obscure, but to clear them up (if it can be done at all) would require a thoroughly careful perusal of the whole minute details of Biot's volume, and for this I have not been able to find leisure.

Je crois pouvoir expliquer par la même théorie les phénomènes des triples images observés par M. Vince et dont j'ai déjà parlé plus haut. Quand je dis expliquer, j'entends ramener ces phénomènes à une même cause, à une même forme de caustique, telle que la disposition des images, et leur marche relative quand elles s'abaissent ou qu'elles s'élèvent, soient des conséquences nécessaires de la forme supposée. Car admettre, comme l'a fait M. Vince, autant de lois différentes de densité qu'il y a d'images visibles, ne me paroît point une explication satisfaisante, puisque les mouvemens respectifs des images restent arbitraires; tandis que, d'après la description qu'il en donne, ces mouvemens avoient entre eux des rapports déterminés.

Malheureusement M. Vince n'a pas observé l'élément le plus nécessaire pour l'explication de ces phénomènes, je veux dire la dépression apparente de l'horizon de la mer. De sorte que l'on ne peut pas affirmer *a priori*, si les trajectoires, dans leur partie inférieure, étoient concaves ou convexes vers la surface des eaux. Cependant je crois pouvoir conclure qu'elles étoient convexes d'après plusieurs raisons que je vais développer.

Ainsi, pendant l'observation du phénomène, qui se fit depuis 4 heures  $\frac{1}{2}$  du soir jusqu'à 8 heures, la température de l'air devoit avoir considérablement diminué, surtout dans les couches supérieures, par l'effet de l'abaissement du soleil. Mais la surface de la mer n'avoit pas dû se refroidir aussi vite. Elle pouvoit donc alors et devoit probablement se trouver plus chaude que l'air, ce qui donne des trajectoires convexes dans leur partie inférieure, et une densité croissante du bas en haut, jusqu'à une petite hauteur; après quoi l'influence de la mer devenant moins sensible, la densité devoit aller de nouveau en diminuant comme à l'ordinaire, et probablement suivant une loi beaucoup plus rapide, tant à cause de l'abaissement subit de la température, qu'à cause de la chute des vapeurs aqueuses qui devoit en résulter, et qui par leur accumulation et par le froid qu'elles produisoient en se précipitant pouvoient contribuer à augmenter la réfraction dans les couches qu'elles traversoient. Ces conjectures sont confirmées par plusieurs remarques de M. Vince lui-même.

Je tire encore des observations mêmes une autre preuve que les trajectoires n'étoient pas convexes dans toute l'étendue de leur cours, comme cela auroit eu lieu s'il n'y avoit eu dans l'air qu'un seul état de densité décroissante de haut en bas. Cette preuve consiste en ce que les deux images supérieures dont la plus haute étoit directe et l'autre renversée, ont été plusieurs fois complètes, c'est-à-dire que le vaisseau y étoit représenté tout entier depuis le sommet des mâts jusqu'au corps même du bâtiment. Or, d'après les expériences que nous avons faites sur le sable à Dunkerque, si ces deux images eussent été données par des trajectoires entièrement convexes vers la mer, ces trajectoires eussent nécessairement formé une caustique qui se seroit élevée au-dessus de la surface de la mer à mesure qu'elle s'éloignoit de l'observateur. Cette caustique auroit donc caché de plus en plus les parties inférieures du vaisseau à mesure qu'il s'éloignoit, et par conséquent les deux images de ce vaisseau n'auroient pas été complètes . . . . On peut encore prouver par les observations de M. Vince que la caustique n'étoit pas formée d'une branche unique, mais de deux branches distinctes réunies par un point de rebroussement et dont la plus basse alloit continuellement en s'approchant de la surface de la mer à mesure qu'elle s'éloignoit de l'observateur. Car puisque M. Vince a vu des images complètes de vaisseaux qui se touchoient par le corps même

du bâtiment, il falloit bien qu'alors le vaisseau reposât sur la caustique; et comme il en a vu aussi d'autres qui se touchoient par le sommet des mâts, il falloit bien qu'alors le vaisseau se trouvât sous la caustique et la touchât par le sommet de ses mâts. Enfin, puisque les images d'un même vaisseau données par ces deux branches s'écartoient continuellement l'une de l'autre, à mesure que le vaisseau s'éloignoit, les deux branches de la caustique s'éloignoient donc aussi l'une de l'autre; ce qui indique une forme . . . . . qui seroit donnée par la combinaison de deux décroissemens de densité contraires.

Cette conséquence déduite immédiatement des observations s'accordant avec l'état décroissant de la température, et avec toutes les apparences que nous avons discutées, je crois pouvoir admettre comme une chose très-probable que, par l'excès de chaleur de la mer, à l'époque où a observé M. Vince, les couches inférieures de l'air se trouvoient dans un état de densité croissante de bas en haut, jusqu'à une petite hauteur, au-dessus de laquelle les densités alloient de nouveau en décroissant par suite de l'abaissement de la température, avec assez de rapidité pour donner des images par en haut. D'après les élévations données par M. Vince, nous devons placer l'observateur dans ces couches supérieures, car il dit avoir observé le phénomène à 25 et à 80 pieds de hauteur. Nous avons déjà examiné précédemment les combinaisons de ces deux états contraires, et l'on a vu qu'elle explique très-aisément les images multiples observées au Desierto de las Palmas et à Cullera, phénomènes qui paroissent avoir le plus grand rapport avec ceux que M. Vince a décrits. Nous supposerons donc, conformément à l'endroit cité, que la caustique avoit une forme  $V'RV'$  (fig. 9). . . . . Soit  $AMH$  la circonférence de la terre,  $O$  l'observateur,  $OMV$  la trajectoire limite tangente à la surface de la mer. Il s'agit d'examiner les phénomènes résultans de cette loi.

La supposition que nous venons de faire sur la non-sphéricité des couches n'est point gratuite, car M. Vince remarque que des vaisseaux également élevés au-dessus de l'horizon apparent présentent des apparences très-diverses, souvent plusieurs images, comme nous venons de le dire, quelquefois deux seulement, l'inférieure constamment droite, la supérieure renversée, d'autrefois enfin on n'en aperçoit qu'une seule directe et reposant sur l'horizon. Les côtes de Calais qui présentent aussi des phénomènes analogues, offroient aussi les mêmes variétés, quelquefois on les voyoit doubles, un instant après elles étoient invisibles. Toutes ces apparences sont contraires à l'idée d'une sphéricité parfaite des couches d'air qui produisoient ces phénomènes, et l'on conçoit en effet qu'étant le résultat d'un équilibre non stable, ils peuvent difficilement s'accorder avec une forme constante.

On this I would remark, generally, that I think Vince is here rather hardly treated. It seems to me, on comparing the two explanations, that the reproach of "*autant des lois différentes qu'il y a d'images visibles*" is not merited by Vince, and would perhaps more justly apply to his censor. It is certainly most unfortunate that Vince did not note the level of the apparent horizon; though, unless he had done so from a great many different heights above the sea, I fail to see how the observation would have helped to decide between the various possible explanations. Biot evidently expected a *depression*, for he states as much in reference to the elevated patches of sea and the "heavy fog" which Vince observed; yet this is inconsistent with his own figure! But the following passage from Vince's paper (in which I have italicised some words) seems to have escaped the notice of Biot.

"The *usual* refraction at the same time was uncommonly great; for the tide was high, and at the very edge of the water I could see the cliffs of Calais a very considerable height above the horizon; whereas they are frequently *not to be seen* in clear weather *from the high lands* about the place. The French coast also appeared both ways, to a much greater distance than I ever observed it at any other time: . . . . ."

Now, one of the most striking of Vince's observations was that of a ship (hull

down) with an inverted image above it, both projected on the confused image of the French cliffs as a background. If Biot's explanation were correct, this background must have been visible by rays of a truly *schlangenförmig* character (as Gilbert calls them), for they must have been at least *twice* (more probably *thrice*) concave downwards; with a convexity downwards, somewhere between the spectator and the ship (and probably another between the ship and the French coast). It seems much more likely that the ship's hull was really beyond the ordinary horizon, and that the French cliffs were visible by rays originally concave upwards so as to rise up, as it were, behind the ship; and then concave downwards, according to the theory I have propounded, from the ship to the spectator.

Biot's memoir shows, throughout, the pervading influence of his almost daily observations of rays which were concave upwards, because passing very close to the ground over extensive surfaces of hot sand. If his explanation of Vince's observation were correct, there would have been an inverted image (of a part of the top-mast) *under* the lowest of the three images, and objects comparatively near hand would have been affected as well as those at a considerable distance.

But there is much more to urge against Biot's view of the phenomena in question. Vince expressly states that "the evening was very sultry." As his observations were made at heights above the sea, varying from twenty-five to eighty feet, it is pretty clear that this sultriness was not due to the exceptionally high temperature of the surface of the sea. Biot, in fact, allows that the effects of this were only sensible "jusqu'à une petite hauteur." But then he assumes (contrary to Vince's statement) a rapid *descent* of temperature at higher levels. This he looks on as developed, *how* he does not tell us, by the *cold* produced by vapour in condensing! Besides, if this were true, it would make the diminution of density upwards *less*, instead of *greater* than usual, and the optical results of such an arrangement would be in contradiction to his explanation.

It is much to be regretted that Vince's description, like his drawings, is of the very roughest character. It is quite otherwise with those of Scoresby. There can be no doubt whatever that Biot's mode of explanation is altogether inapplicable to the majority of Scoresby's observations.

I quote a single passage\*, which is apparently decisive.

"A dense appearance in the atmosphere arose to the southward of us . . . . When it came to the S.W. of us, I first noticed that the horizon, under this apparent density, was considerably elevated. . . . . Two ships lying beset about fourteen miles off, the hulls of which, before the density came on, could not be wholly seen, seemed now from the mast-head not to be above half the distance, as the horizon was visible considerably beyond them."

Had the arrangement of strata here been as Biot supposes in Vince's case, only the top-masts would have remained visible, the apparent horizon would have come in front of the hulls, and there would have been inverted images of nearer objects visible *under* the objects themselves.

\* Scoresby's *Arctic Regions*, i. 387 (1820).

It will be noticed that these observations were taken over a surface of *ice* in which the vessels were "beset." The sun is said to have been "powerful," but the lowest strata of air, in contact with ice or ice-cold water, must have been colder than those above them. The haze, or "density" as Scoresby calls it, probably consisted of minute drops of water, and would thus be much raised in temperature by the sun. In connection with this I may mention that when a trough, in which brine has been diffusing for some time into water, is suddenly and roughly stirred for a short period, it settles in a few minutes into a large number of strata of different densities. Something similar must hold in the case of air irregularly heated, and thus we have a very probable explanation of the *series* of inverted images figured by Scoresby. The strata which produced these, in all likelihood produced direct images also, but (except on very rare occasions) so small in vertical dimensions as to have escaped observation. In the absence of wind such strata, once formed, would last for a long time, in consequence of the very small thermal conductivity of air. I might also refer to an interesting case of inverted images seen from a balloon by Tissandier\*. The height at which the balloon was situated is not stated expressly, but from the context it must have been somewhere about 6000 feet. This, of course, *proves* the existence, at a great elevation, of a stratum in which there was a comparatively rapid diminution of refractive index with increasing height.

I will quote, in conclusion, Scoresby's account of his remarkable observation of an isolated inverted image of a ship, which was situated far beyond the horizon. His drawing is reproduced as the second of the series in fig. 1. The obvious and simple explanation of this is what has already been mentioned for Tissandier's observation, though, of course, it could also be accounted for by an infinite number of different laws of refractive index, all of more or less ingenious complexity.

"The atmosphere, in consequence of the warmth, being in a highly refractive state, a great many curious appearances were presented by the land and icebergs. The most extraordinary effect of this state of the atmosphere, however, was the distinct inverted image of a ship in the clear sky, . . . the ship itself being entirely beyond the horizon. . . . It was so extremely well defined, that when examined with a telescope by Dollond, I could distinguish every sail, the general 'rig of the ship,' and its particular character; insomuch that I confidently pronounced it to be my Father's ship, the 'Fame,' which it afterwards proved to be; though, on comparing notes with my Father, I found that our relative position at the time gave our distance from one another very nearly thirty miles, and some leagues beyond the limit of direct vision†."

It seems hard to reconcile the clearness of definition in this case with any other than a stable state of equilibrium of a transition stratum. The mirage of the desert, where the equilibrium is essentially unstable, is always exceedingly unsteady.

Biot makes a point, to which I have not yet alluded, from Vince's statement that the inverted image appeared to rise as the object moved farther away. His mode of explaining this, however, savours of the "*autant des lois différentes*," &c.; and, besides, the result follows quite as directly from my explanation as from his.

\* Glaisher's *Travels in the Air*, p. 297 (1871).

† Scoresby's *Journal of a Voyage to the Northern Whale Fishery* (1823), p. 189.

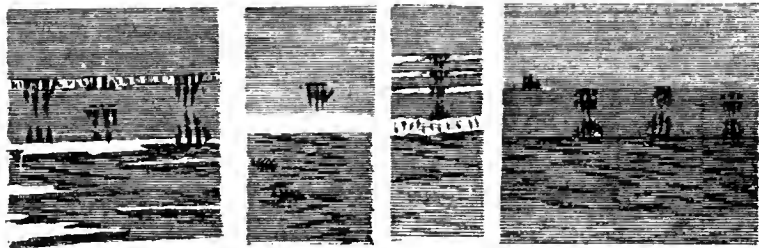

Fig. 1

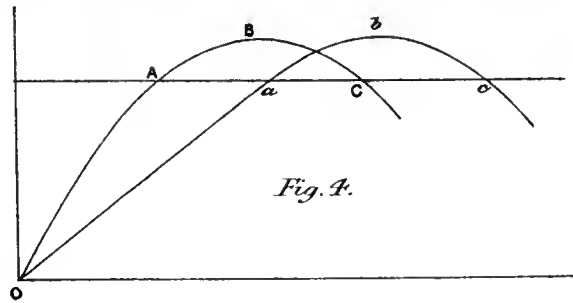

Fig. 4.

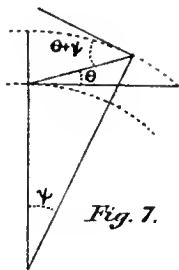

Fig. 7.

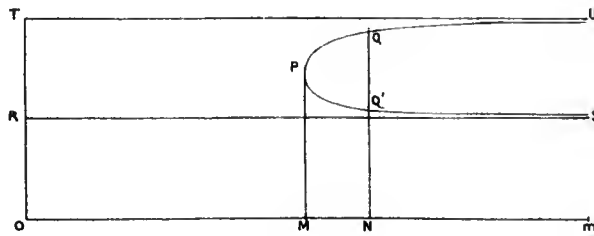

Fig. 5.

Fig. 3.

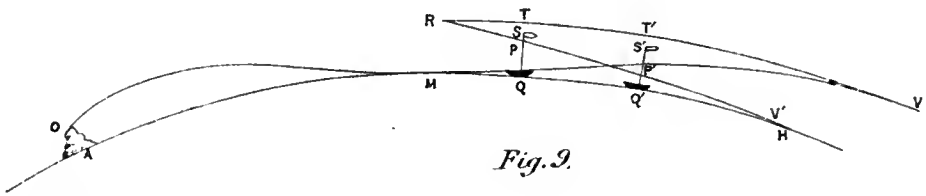
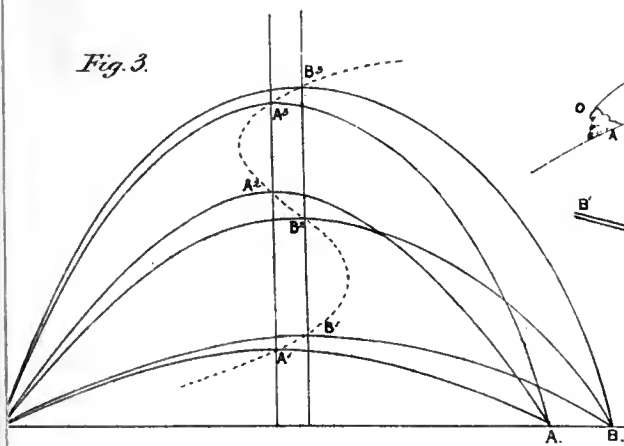

Fig. 9.

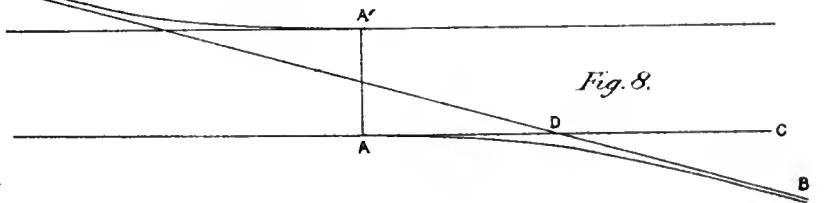

Fig. 8.

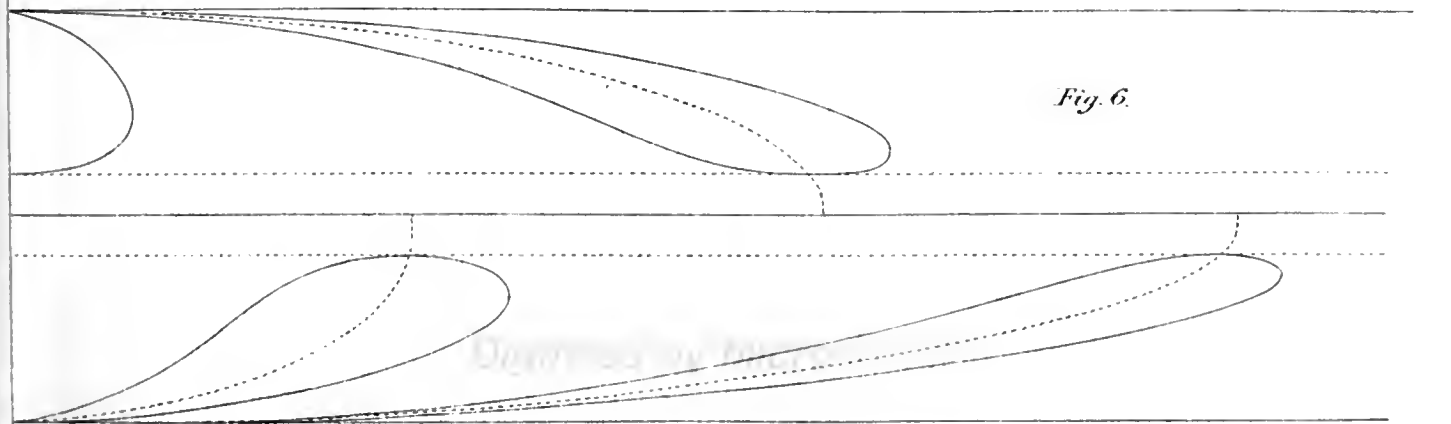

Fig. 6.

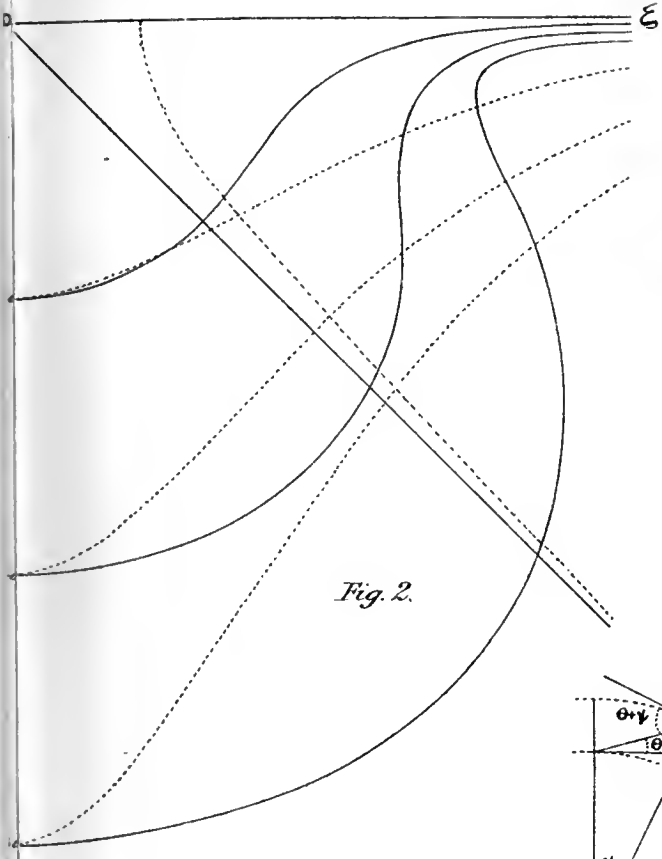

Fig. 2.



Vince's observations were by no means precise enough to make this point certain; besides, he speaks of the top-masts and not of the hulls; and, from the diminution of the image as the distance increases, it may be quite true that the top-masts appear to rise in the inverted image while the hull really sinks. At any rate it is assuredly *not so* in the majority of Scoresby's careful figures. In fig. 1 several examples are shown of multiple images of ships at different distances in nearly the same direction; and in all it will be observed that the inverted image of the hull is lower as the vessel is farther off. Also that in the upper direct image the hull appears to rise as the vessel recedes.

[Feb. 10, 1883.—I have to acknowledge the kindness of Mr J. W. L. Glaisher in verifying, and in some important instances correcting, the numerical values given in §§ 10 and 15. My own original calculations, made for the most part with four-place logarithms only, were insufficient to give accurately the values of  $\mathcal{E}$  close to the critical point. The reason is obvious from the form of the expression for that quantity as given in § 12, above.]

[The main results of the preceding paper are given, in a less technical form, in *Nature*, XXVIII. p. 84, "State of the Atmosphere which produces the Forms of Mirage observed by Vince and by Scoresby." 1898.]

## LIX.

## SOLAR CHEMISTRY.

[*Nature*, Vol. xxiv., October, 1881.]

THE researches of Mr Lockyer, and others, summarised by him in recent numbers of *Nature*, have to a great extent complicated the aspect of this grand problem, which appeared so simple to Stokes and Thomson in 1852, and to Stewart and Kirchhoff a few years later.

I wish to consider briefly, what are these new and puzzling complications of the solar problem; and whether we may not still preserve our belief in the existence of *essentially different* elementary atoms, which is the basis of the beautiful Vortex Theory. For it seems that to hazard (however *naturally*) such a step as is involved in assumed dissociation of the (so-called) elements, before we make certain that no less serious hypothesis will account for the observed facts, is contrary to the spirit of Newton's *Regulæ Philosophandi*.

The most prominent of these complications seem to be—

(1) The variations of the relative brightness, width, &c., of the lines in the spectrum of a particular substance, in dependence on the source and circumstances of its incandescence.

(2) The so-called "long" and "short" lines. (These, as will be seen, are probably a case of (1).)

(3) The fact that, in the spectra of sun-spots, *some* lines supposed to be due to a particular element indicate rapid motion of the glowing gas; while others, supposed due to the same element, give no such indication.

(4) The (at least apparent) coincidence of lines in the spectra of two or more elementary substances.



To these may be added:—

(5) The remarkable peculiarities of star-spectra; especially the paucity, and the breadth, of the lines in the spectra of *white* stars.

As regards (1), let us consider a sounding body with a large number of different modes of vibration, exposed to impacts either periodic or at least with an average period. The relative intensities of the various notes which it can give will obviously depend upon the period of the impacts. Now this is precisely the case of a particle (I use the word to avoid misconception) of a glowing gas. The average number of blows it receives will depend on (a) the number of particles per cubic inch (and also upon *whether there be another gas present or no*, a point of very great importance), and (b) the temperature, which is directly connected with the speed of the particles.

Change the density, the temperature, the admixture with foreign substances, or any two, or all, of these; and the *average period of the battering* to which a particle is subjected may be so altered as to elicit from it *in any required ratios of relative intensity* the various simple rays it can give out.

It will readily be seen that this may account for all of the phenomena of classes (1) and (2) above.

(3) may be accounted for in many ways. I mention only one, as my object is merely to show that we are *not yet* compelled to accept dissociation of so-called elements even in its mildest form. Other modes of escape, though not quite so simple, present themselves.

What is seen in a sun-spot is the integral, as it were, of all that is taking place (as regards both radiation and absorption) in many thousand miles of solar atmosphere, containing the same substance under the most varied conditions. That portions in which certain lines of that substance are prominent over others may be at rest relatively to the observer along the line of sight; while others, in which (from different density, temperature, or admixture, as above explained) other lines are specially prominent, may have large relative velocities, is certain. This would at once account for these singular observations.

As to (5) we must remember that in a star-spectrum we have, as it were, a *triple* integral. For we not only integrate through the depth of the atmosphere, but also over the whole surface of the star; spots, hurricanes, and rotation of the whole, included. This is equivalent to the *superposition* of innumerable separate spectra, no two of which may have *any one* individual line in the same place or of the same breadth, &c. Feeble lines may, in fact, entirely disappear under such treatment.

(4) If not due to want of dispersive power in the apparatus, this may be legitimately attributed to inevitable impurities. It is only in "tall talk" (or in advertisements) that any human preparation, elementary or not, can be spoken of as "*chemisch rein*." And we all know how faint a trace of impurity can be detected by the help of the spectroscope.

Even in the last resort, I see nothing to hinder the existence of exactly equal vibration-periods in two perfectly distinct vortex-atoms:—though their occurrence is extremely improbable.

If we could get an absolutely transparent gas; one, therefore, which could give no radiation under any circumstances; the study of the behaviour of a given quantity of hydrogen mixed with different proportions of it in a vessel of given size, and subjected always to the same conditions of incandescence, would give us invaluable information.

## LX.

THE PRESSURE ERRORS OF THE CHALLENGER  
THERMOMETERS.

*Challenger Narrative*, Vol. II., Appendix A.

[Plate XII.]

THOUGH the contents of the following paper have been, with the sanction of Sir Wyville Thomson, communicated at intervals during the last two sessions, and in particular on April 4th, 1881, to the Royal Society of Edinburgh, they are now published for the first time. The brief abstracts which have appeared in some scientific journals have given an inadequate, and by no means accurate, account of my method and results.

The subject is the reduction of the deep-sea observations which were made on the Challenger, in so far as these are affected by pressure. The thermometers employed had protected bulbs; but the stems, in which there were certain aneurisms<sup>1</sup>, were wholly unprotected. The determination of the necessary pressure corrections is of great importance, especially in the bearing of the results upon ocean circulation and other grand points of physical geography;—and when, at Sir Wyville Thomson's request, I undertook the inquiry, I resolved to carry it out with a degree of accuracy suitable at once to the capabilities of the thermometers employed and to the magnitude of the issues involved.

In the course of my work several improvements, which may be useful in future investigations of a similar kind, have suggested themselves; but my primary object was simply to find how to obtain the most trustworthy results from a set of

<sup>1</sup> From *ἀνεύρησμα*, a widening or swelling (*ἀνά* and *εὐρύς*); *not*, as is sometimes stated, *ἀ-νευρος* (without sinews). Hence the word is correctly used for the peculiarity in the thermometers.

observations already made, the instruments with which they were made having been put in my possession.

The work has extended through a very considerable time, having occupied my leisure moments for a large part of each of the last three years. The nature of the difficulties which were successively met with and overcome will be easily seen from what follows without further preface.

The whole matter looks uncommonly simple now that the instrumental and other difficulties have been discovered and met, and I have recently repeated the investigation in a tenth of the time it originally cost me. The data given in columns 7, 8, 9, 12, and 13 of the Table in Appendix E below, are (with the exception of those for one thermometer in which the mercury column had been accidentally broken) those obtained in this repetition of the inquiry. They were found to agree so well with the earlier data that it was considered unnecessary to print these.

I found myself at the beginning of the inquiry very much in the position of a chemist who has given to him a mixture containing half-a-dozen absolutely unknown elements, all in very small and in nearly equal quantities, and who is required to determine the nature and properties of each, and also the proportions in which they occur in the mixture.

A great many very curious offshoots have sprung from the inquiry, some of which are of real scientific importance. For instance, the determination of the amount of heat developed by exposing to very high pressures, under different circumstances, various kinds of substances. This question, so far as I am aware, has as yet been treated (even theoretically) only for moderate pressures. Again, there is the very curious question, What is the cause of the breaking of a piece of glass or other fragile body, under hydrostatic pressure? Does it break in consequence of uniform compression, or of shearing, or of extension only; and at what amount of compression, or shear, or extension, does it give way? And there is the very important practical question of the accurate measurement of pressures greater than can readily be compared with the weight of a tall column of mercury. Amagat has successfully worked with a column of mercury of more than 1000 feet in height, corresponding to a pressure of about 3 tons weight per square inch. But there is a limit, to experiment in this direction, which he has nearly reached. The simple and easily manageable apparatus described below has been found capable of giving results of considerable accuracy up to pressures of 12 tons weight on the square inch, and will probably be applicable much farther.

After some consideration I have decided to give, first, a general account of the whole work in terms which will be easily intelligible to all readers; and then to develop at length special parts of the inquiry which have scientific interest, either pure or practical, but which are not of a nature to be easily comprehended except by specialists. Of course I reserve for the latter part the proofs (experimental or mathematical) of the statements now to be made.

For convenience, this subject is arranged as follows:—

*The Pressure-Corrections supplied to the Challenger along with the Thermometers.*

*Construction of the Thermometers.*

*Wholly protected Instruments. Their Defect.*

*Individual Peculiarities of some of the Challenger Thermometers.*

*Captain Davis' Mode of Testing; and his Correction for the Maximum Side.* (With this Appendix C.—*Heating of Water by Compression.*)

*Consequent Correction for the Minimum Side.*

*Theoretical Determination of the Direct Effect of Pressure. Experimental Verification.* (With this Appendix A.—*On the Accurate Measurement of High Pressures.*)

*The Aneurisms. Their Objects and Effects.* (With this Appendix B.—*Calculation of the Effect of an Aneurism.*)

*Imploding and Exploding of the Thermometer Bulbs.*

*Description of the Apparatus for applying Pressure.* (Extended in Appendix D.)

*Accurate Measurement of great Pressures.* (Also Appendix A.)

*Internal Pressure Gauges.*

*External Pressure Gauge.*

*Results of the Experiments. The true correction for pressure is very small.*

*Sources of the large effect obtained in the Press.*

*Final Conclusion from the Investigation.* (Detailed in Appendix E.—*Tabular Synopsis of the General Results of Experiment and Calculation.*)

These we will now take in order.

*The Pressure-Corrections supplied to the Challenger along with the Thermometers.*

When I was first asked to examine the thermometers I judged from the appearance and nature of the protection over the bulbs, that very slight corrections only would be required, even for the greatest pressures to which they had been exposed. But Sir Wyville Thomson told me that a correction of at least half a degree Fahr. had been assigned for them for every mile under the sea. This correction had been given him by Captain Davis of the Admiralty, who had in his experiments<sup>1</sup> the assistance and advice of such exceedingly able experimenters as the late Professor W. Allen Miller and others.

Hence, although it appeared to me at first sight incredible that any such correction should be required for thermometers with protected bulbs, I considered it absolutely necessary to try Captain Davis' experiments over again, under the same conditions as those which he had adopted in conjunction with Professor Miller. My object was, of

<sup>1</sup> "On Deep-Sea Thermometers," by Captain J. E. Davis, R.N. (*Proceedings of the Meteorological Society*, April 1871).

course, to find out whether I could again obtain these results, and, if I could obtain them, to discover what were the causes which led to their being so exceedingly different from what I should have expected. I felt assured that the results were much too large;—and I had therefore, if I could reproduce them, to trace the various possible causes of divergence between the results of experiments conducted in a hydrostatic press and of other similar experiments made at the same pressures in the deep sea.

Half-a-degree Fahrenheit per mile of depth may seem to be a matter of very little consequence; but when we recollect that some of the Challenger soundings were made at depths nearly approaching six miles, we find that we have sometimes to deal with a correction of 3° F., enough to modify seriously our theories of ocean circulation. For it can never be too strongly impressed on the student of science that there is no such thing as greatness or smallness in itself; what is very small relatively to one class of quantities may be very great relatively to another and different one. All the temperature differences, except near the surface of the sea, though important in their consequences, are very small relatively to differences of temperature in the atmosphere; but, just because they are so small, small errors in the determination of their values are important:—thus it was imperative to decide whether the corrections assigned by Captain Davis are necessary.

At first sight one might think that by far the best way of conducting an inquiry of the kind would be to carry it out under circumstances nearly the same as those of the Challenger observations. No doubt, if we had at hand a coal-pit or mine-shaft full of water, and of six miles or so in depth, we might make the experiments without the aid of presses, and under circumstances far more favourable than those in which I was obliged to operate. The reasons for this statement will appear presently. There are great objections to making test-observations at sea. The Challenger observations themselves had, of course, to be made at sea, but to make under similar circumstances experiments for the purpose of determining corrections would be a perfectly hopeless attempt. The circumstances under which thermometers are let down and drawn up again at sea are extremely unfavourable to accuracy of observation. I had, therefore, to content myself with such conditions as could be procured by means of hydrostatic presses.

#### *Construction of the Thermometers.*

I will now say a word or two about the construction of the thermometers themselves; and I shall thus have an opportunity of pointing out some of the peculiarities of construction to which I have traced the greater part of the very large effects obtained by Captain Davis, and given by him as corrections which required to be made.

The Challenger thermometers are all of the Six pattern: there is a highly expansible liquid in the large bulb, which projects to a certain extent into the narrow U-tube. Then there is a column of mercury occupying the bend of the U and part of each stem. Above that, on the maximum side, there is some more of the sensitive liquid; and at the ends of the mercury column are the maximum and minimum indices, each containing a

piece of steel, so that they can be set by means of an external magnet. The large bulb on which the temperature effects are mainly produced is protected by an exterior shell of glass strong enough to resist a pressure of at least 5000 fathoms of sea-water; that is to say, approximately, somewhere about six tons weight per square inch. This external shell is nearly filled with alcohol. The main difference between this and the

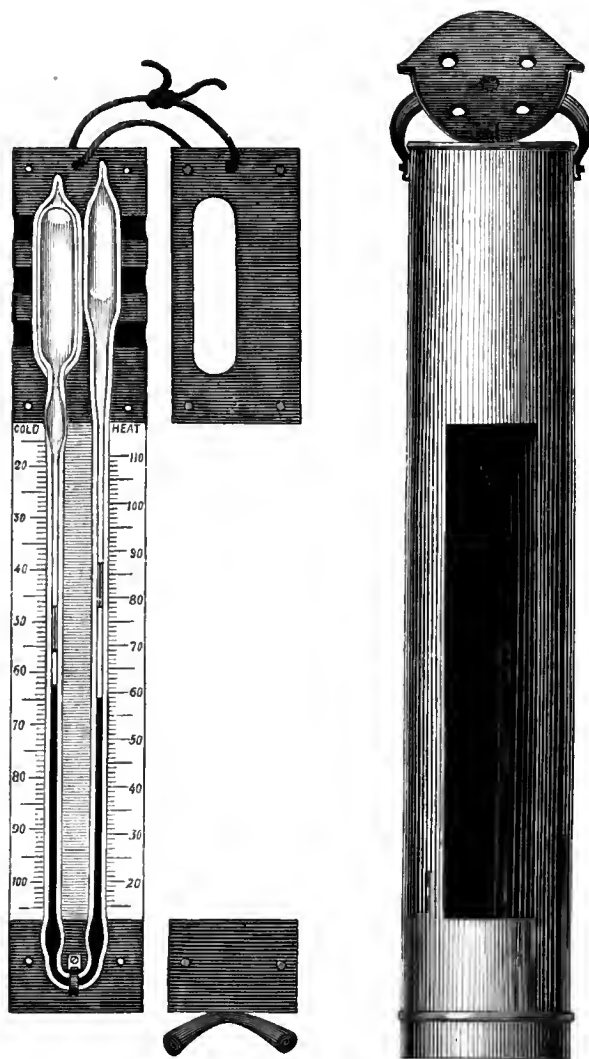

first invented form of protected thermometer, which (so far as I know) was introduced by Sir William Thomson<sup>1</sup>, is simply that the bulb only is protected, the stem being

<sup>1</sup> "The Effect of Pressure in Lowering the Freezing-point of Water experimentally demonstrated," by Professor W. Thomson (*Proc. R.S.E.*, February 1850). See also the paper by Parrot (1833) quoted below. In this a protected thermometer was undoubtedly employed; but the protecting sheath was part of the wall

exposed, and therefore the effects produced directly by compression are due solely to the stem of the instrument: unless, indeed, there be a strain produced on the protected bulb (altering its volume) by the wry-neckedness of the protecting shell.

Now, as a rule, till quite recently, practical workers in glass supposed that no effect at all would be produced by pressure upon an ordinary thermometer stem, simply because the external diameter is so much greater than the internal; and, in fact, so little was the nature of the effects of hydrostatic pressure known to practical glass-blowers that one of Mr Casella's workmen undertook in 1869 to furnish Captain Davis with thermometers whose bulbs should be so thick as to "*defy compression*"! It will be seen presently that such an idea is entirely absurd:—that, however thick is an unprotected thermometer, it will still have its indications altered by compression, and very nearly as much as a thinner one, unless that be extremely thin. So far as the Challenger instruments are concerned, the only effect that can be expected to be produced directly by pressure is the diminution of the bore and length of the narrow tube, and the consequent forcing of the liquid which occupies it to fill a greater length in it. I made at starting a rough calculation of the amount of effect of this kind which was to be expected; taking average data as to the compressibility and rigidity of glass. I found it to be a small fraction only of a degree for each ton-weight of pressure, except on those thermometers which had very short degrees. It was clear to me, therefore, that (unless the wry-neckedness already mentioned was the cause) the larger part of Captain Davis' result was not due to pressure directly.

#### *Wholly protected Instruments. Their Defect.*

For the purpose of comparison with the Challenger instruments, so far as regards the effect on the unprotected stem, Sir Wyville Thomson sent me two mercury thermometers constructed after Sir William Thomson's device. In these instruments the whole, bulb and stem alike, is enclosed in a strong glass tube, nearly filled with alcohol. The effects of pressure on these instruments were very much smaller than on the thermometers of the Challenger. This result was so unexpected that I at first thought it due to defects in the new instruments. But, as will be seen later, it is quite consistent with the final result of my investigations. It is, however, very difficult to obtain good results from these instruments under the circumstances in which I was working. Their recording adjustment is constructed on a new plan, in which a little portion of mercury is detached from the rest; and separated from it by a small quantity of air, which does not move it until compressed to a definite amount. To set the index before an observation, the instrument has to be swung round somewhat sharply at arm's length. It was scarcely ever possible under these circumstances to

of the compression apparatus and was not attached to the thermometer itself. From a reference in this paper I was led to consult Lenz's observations on deep-sea temperatures. He appears to have measured these temperatures by bringing to the surface, with great care, a considerable quantity of water from each depth. There was a thermometer in the collecting apparatus, with a bulb of extra thickness; but no recording index was employed, so as to show what was its indication under pressure.



adjust it to the temperature of the water in the press. The indices in the Challenger thermometers, on the other hand, consist each of a piece of enamel with a couple of hairs attached to it so as to fix itself in the tube and retain a record of the observation. They have also a little piece of needle inside, and can thus be moved from the exterior by means of a horse-shoe magnet, so that the adjustment can be made at pleasure, and without any alteration of the temperature. The thermometers are plunged for some hours in the water in the press, and the indices are set in an instant while the instrument is partially lifted out for the purpose. With the other instruments one might spend days before he could get them introduced, except after special cooling, into the press with the index suitably adjusted to the temperature of the water. The whole difficulty might have been avoided by putting an exceedingly small piece of iron or steel wire above the index, to be acted on by a sufficiently powerful magnet.

Thus, although these instruments are absolutely perfect so far as regards immunity from pressure (and in other essential respects which will be mentioned later), it is not easy to work with them under the circumstances of this investigation.

*Individual Peculiarities of some of the Challenger Thermometers.*

The Challenger thermometers are not all exactly similar to one another. Some of them have their degrees very much longer than others; others have the extraordinary peculiarity that the degrees upon the maximum side are nearly half as long again as those on the minimum side, and sometimes it is the reverse. In one of the instruments which was occasionally used in the deep sea, the length of a single degree on the maximum side is only about three-fourths of a millimetre, and thus a reading to a tenth of a degree is not to be looked for. But on account of this unexpected peculiarity, this particular instrument was of use, as will be seen later, in demonstrating that the effects produced in the press were due partly to heating, partly to compression. Several instances of useful peculiarities of a similar character were detected, and utilised.

In fact, the instruments cannot be said to do more than furnish rough and ready means of approximating to temperatures within about a quarter of a degree, or in the most favourable circumstances a tenth of a degree Fahrenheit. Had they been more nearly what would be called "scientific" instruments, they might have altogether failed on account of the rough treatment to which they were necessarily subjected during use. Letting them down into the sea presents in general no great difficulties, but when they have to be hauled on board again they are subject to jerks and shocks, and sometimes swing through large arcs at the end of the lead line. Such misadventures are unavoidable at sea, and are excessively unfavourable to accurate results, because the index is necessarily not fitted so tightly in the stem that it may not in a few oscillations be sensibly displaced. And there is a defect inseparable from the use of movable indices:—viz., that the reading of the mercury column is sensibly different according as the index is, and is not, in contact with it. The capillary convexity affects the maximum and minimum indices in *opposite* ways.

Further, I may observe (though it does not affect my work) that in these thermometers the scale is at some distance from the mercury in the stem, and no provision is made for avoiding parallax or personal equation. By merely altering the position in which one holds the thermometer, it is possible to read the temperature whether by the mercury column or the end of the index next it, to an amount different in some of the thermometers by as much as a quarter of a degree, and in the great majority of them by as much as a tenth. Thus if we get readings consistent within a tenth of a degree we get all that the instruments are capable of furnishing. I have therefore always read the thermometers in exactly the same position and (when so much accuracy was attainable) only to the nearest tenth of a degree. And I have always made my comparisons between successive positions of the index; the only readings of the mercury directly being taken roughly to find whether any permanent temperature-change had been produced in the water of the press by pressure or otherwise, during the course of an experiment.

A great many different materials were tried for the framing of the thermometers: and vulcanite was finally chosen, having been found to answer the purpose exceedingly well. Wood warped, and metal was unsuitable for various reasons. It is rather curious to find, as will be seen below, that this substance was one of the main causes of the very large amount assigned to the pressure-correction.

*Captain Davis' Mode of Testing; and his Correction for the Maximum Side.*

It is necessary to look somewhat closely into the mode in which Captain Davis conducted his experiments, in so far at least as it differs from the one I afterwards employed; in order that we may be able to form an idea how, with nearly all the facts before him, he yet failed to get their proper interpretation. Take, for instance, the way in which he attempted to determine the correction which is due to the heating of water by compression. This, of course, affects the thermometers while in the hydrostatic press, but *not* when they are let down into the sea. When the water in the press is compressed with the thermometers in it, it becomes hotter as the pressure increases (so long at least as its temperature is above 4° C. or 39°·2 Fahr., that of its maximum density). This is quite analogous to the heating of air in a cylinder when a piston is suddenly forced down; when, as every one knows, tinder can be kindled by the heat developed. So water is heated by compression, but not to anything like the same extent. But it is necessary to remark that the amount of heating of water by a given compression depends in a very curious manner upon the original temperature of the water. For water taken at its maximum density is neither heated nor cooled by compression, but it is heated by compression if it is at a temperature higher, and cooled if it is at a temperature lower, than that of the maximum density. One set of Captain Davis' observations were made in water at temperatures near, but under, the maximum density point: in which, therefore, very little effect can be produced, even by very great pressure (and that little should be cooling, not heating), and he combined these with a number of other observations made at temperatures approaching 55° F., in which a

comparatively large amount of heating is produced even by moderate pressures. The average of the results of these determinations was taken, but, unfortunately, Captain Davis struck out before taking the average all those observations which appeared to give much larger effects than the others, taking them as being obviously erroneous.

When we sift out from the observations all those made nearly at any one temperature we find they agree fairly enough with the theoretical result of the compression. But observations made at different temperatures were included in the group from which the average effect was deduced. Such an average has no physical meaning.

As this is a point of some importance, I shall give a graphic representation of one set of the observations, those made with one of Sir William Thomson's thermo-

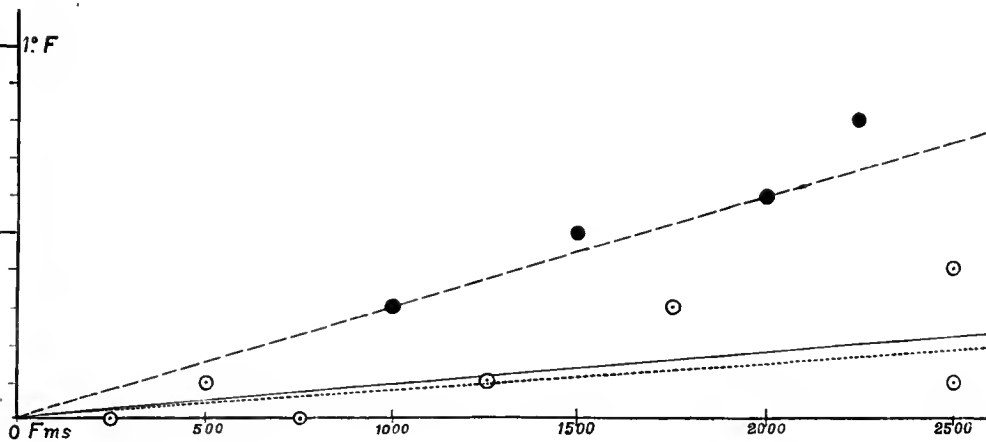

imeters; showing which were rejected, the average thus obtained, what ought to have been obtained, and also the strict theoretical result. In the diagram above, pressures are measured in fathoms of sea water along the horizontal line, and the corresponding changes of temperature, shown by one of the completely protected thermometers, are represented by vertical lines. The centres of each of the series of white and black spots inserted in the diagram represent the various observations made by Captain Davis and Professor Miller at temperatures near  $55^{\circ}$  F.

If we suppose that all these observations had been made in precisely similar circumstances, a fairly approximate way to get the average effect indicated would have been to draw a line through the series of spots in such a way that the average distance from it of those which lay above, should be equal to that of those lying below. This would have shown a rise of temperature of the water in proportion to the increase of pressure, but its amount would have been considerably under the truth. But the experimenters used only the white spots; and by the help of these drew the full line in the figure as indicating their average; thus obtaining a very slow increase of heating by pressure.

By the help of Sir William Thomson's<sup>1</sup> formula for the heat developed by compression, I have calculated what amount of heating should have been obtained in these experiments, on the supposition that the pressure is applied with sufficient suddenness to let the full effect be produced on the thermometers before there is any sensible absorption of heat by the walls of the pressure vessel: and on the farther assumption (not, as will be seen, justified by experiment) that there is no heating of the glass protecting sheath by pressure. It is represented by the dashed line in the figure, and it is certainly very remarkable that this line (the true one) runs through the group of rejected observations, paying as it were no attention whatever to those which were retained! The formula referred to is discussed in Appendix C below; but, as will be seen at a later stage, the effect on the protected thermometer is not due solely to the heating of water by compression.

Captain Davis concluded from two sets of observations, one at 55° F. and the other about 39° F., that little attention need be paid to the heating of water by compression, (obtaining, in fact, the dotted line), and thus that the effect observed in the hydraulic press was due mainly to direct pressure, and would, of course, be experienced by the thermometers when they were let down into the sea.

The officers who managed the thermometers of the expedition, were, in consequence, furnished with corrections for each thermometer, all of the order already indicated, *i.e.*, about half a degree for each mile under the surface of the sea. These corrections were, of course, for the *maximum* side of each instrument.

#### *Consequent Correction for the Minimum Side.*

Looking at the thermometers, it seemed to me perfectly evident that this correction, if it was to be applied at all, must be applied in very nearly the same amount both to the maximum index, for which it was determined, and also to the minimum. Any difference between these two must be due solely to the effects of temperature upon the column of mercury which lies between the two indices, and of pressure on the tube containing that mercury. Unless the heating effect were *confined* to the space between the indices, the former is provided for by the graduation of the instrument itself; and it was quite certain that the two together could not produce an effect amounting to more than a small fraction of the degree and a half for three tons pressure.

Therefore, as all the readings of the Challenger thermometers were taken from the minimum index, they were subject, according to my interpretation of Captain Davis' results, to a correction of very nearly half a degree Fahr. for every mile of depth.

Now, even if the heating effect on the water in the press had been correctly determined, the result would have led to a deduction of at the utmost only about one-fourth of the whole correction, thus still leaving a very formidable correction indeed.

<sup>1</sup> "On the Alterations of Temperature accompanying Changes of Pressure in Fluids," by Professor W. Thomson (*Proc. R. S.*, June 1857).

*Theoretical Determination of the Direct Effect of Pressure. Experimental Verification.*

I therefore calculated the effect of pressure on a thermometer tube, assuming the best data for the compressibility and the rigidity of glass. The investigation is given in Appendix A to this paper. As the matter is of considerable importance, I have developed the formulæ sufficiently for application to any case of the kind which is likely to occur. The result, so far as is required for the present argument, is that the internal capacity of a glass tube (whose walls are thick in comparison with the diameter of the bore) is reduced by about  $\frac{1}{1000}$ th part for each ton weight (per square inch) of pressure applied from without; the ends being closed. Hence, if such a tube be partly filled with mercury, with an index above it; the index should be displaced by  $\frac{1}{1000}$ th of the length of the column of mercury for each ton weight of pressure applied to the outside of the tube.

I tried the experiment with a thermometer tube, the length of the mercury column being as nearly as possible a metre, and I found for every ton weight of pressure to which the tube was exposed the index was displaced by one millimetre, the  $\frac{1}{1000}$ th part of the length of the column precisely, being far more nearly than I had expected the result I had already calculated from theory. Since, then, there is only a change of one-thousandth in the length of the column, it is quite obvious that the amount of effect produced upon the column of mercury in the Challenger thermometers (which is not above a sixth or a seventh of a metre in length at the utmost), that is to say, the whole correction-difference between the maximum and minimum indices is a matter of a sixth or seventh of a millimetre; or in general very nearly the same fraction of a degree of the scale. Thus it is proved in two different ways that the correction supplied by the Admiralty, if it is to be applied at all, ought to be applied almost in its entirety to the minimum index.

*The Aneurisms. Their Object and Effects.*

There is another peculiarity of the Challenger thermometers which leads to a slight—but only a slight—modification of this statement, viz., that at the lower end of each of the two vertical columns there is an aneurism on the tube. These form a sort of secondary bulb, making the tube faulty again after the primary bulb has been protected. Their effect is slightly to increase the effective length of the column of mercury.

I learned from Sir George Nares that the object of these aneurisms, and of another which is situated close to the bulb, is to prevent the indices from being jammed at the bends of the stem, or forced into the bulb, when the instrument is exposed to very high or very low temperatures. They seem to be in every respect objectionable, especially as the necessity for them would be entirely removed by adding an inch or two to the length of the instrument; or, if they must be retained, by *protecting* them and using more powerful magnets. Their presence produces an effect large compared with their apparent importance. The sketch subjoined represents, on a

large scale, one of the most highly developed of the more effective of these aneurisms, that which is situated close to the main bulb of the instrument.

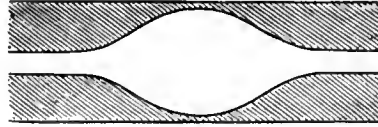

By reason of the convexity of the thermometer tube the diameter of the bore appears from the outside to be considerably larger than it really is. In fact a very simple geometrical construction shows that the ratio of its apparent diameter to its real diameter is that of the refractive index of glass to unity, *i.e.*, it appears to be about 1.6 times its actual diameter. So that even when the aneurism, and the liquid filling it, appear to occupy the whole diameter of the tube, they only occupy  $1/1.6$  or about two-thirds, so that even in this extreme case the walls of the aneurism are not usually very thin. The percentage diminution of volume of the middle portion of the aneurism is in such a case (roughly) 50 per cent. greater than that of the unaltered tube.

The real mischief done by the aneurism is not due mainly to thinness of the walls and consequent greater liability to distortion by pressure; it is due to the fact that the aneurism, in consequence of its greater section, contains a much larger quantity of mercury than does an equal length of the tube; and therefore that a small percentage diminution of its volume will produce a marked displacement by the outflow into the narrow tube. Several of the aneurisms I have measured produce a disturbance of the index corresponding to that produced by at least five times their own length of the tube.

In some of the more exaggerated ones it actually produces an effect on the maximum and minimum index equal to that due to the extension of very nearly one-half of the mercury column in the thermometer. But this, though easily remediable, is not a defect of much consequence. [The calculation of the effect due to an aneurism is given in Appendix B.]

#### *Imploding and Exploding of the Thermometer Bulbs.*

In connection with the breaking of some of the thermometers, as a result of pressure whether in the press or in the sea, it may be well to describe the curious nature of the effects produced by pressure upon the material of a tube, according as the pressure is applied from without or from within.

First, with regard to the thermometers themselves, which are exposed to external pressure, but have comparatively very slight pressure applied in the interior of their bore; and second, the corresponding effect when pressure is applied, as in the press itself, from the inside and tends to stretch the walls. [This second case has occurred with one or two of the Challenger thermometers also. Its source is usually defective

strength of the terminal bulb of the maximum end of the tube. This bulb implodes, then the pressure is applied to the *interior* of the protected bulb, which, in its turn, explodes.]

In the diagrams below, the first three figures refer to part of the walls of the glass tube, which is exposed to pressure from the outside, but has no corresponding pressure applied within. The effects of pressure indicated are those in a transverse section of the tube. The circles represent (on a large scale) transverse sections of very

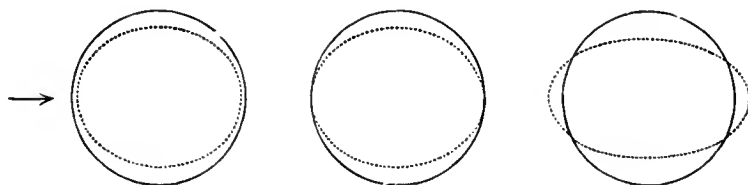

small spherical elements of the glass wall of the tube, the first close to the outside, the second in the middle of the wall of the tube, and the third close to the inner surface. The ellipses which are drawn along with the circles represent (of course, with much exaggeration) the corresponding transverse sections of the ellipsoids into which the spheres are distorted by the external pressure. The sphere near the outside is compressed in all directions, but much less in a radial direction than it is in a direction perpendicular to the former. The greatest amount of compression is tangential as it were, and the circular section of the sphere has been compressed into an ellipse which has a major axis in the radial direction very nearly equal to its original length, while the minor axis is very considerably reduced. The second figure refers to a small spherical portion inside the glass wall originally situated at a distance from the axis equal to 1.6, times the internal radius of the tube. (It is curious that the number 1.6, though obtained from a totally different source, should be so nearly the same as that already quoted as the refractive index of the glass.) The little spherical element at that place suffers no radial compression, but there is considerable tangential compression. Close to the interior surface of the glass tube we find large compression in a tangential direction and actual extension in the radial direction. These diagrams have been purposely exaggerated to make the effects visible. They represent what would be the effect of a pressure of 650 tons weight per square inch, provided glass could stand such a pressure and still continued to follow Hooke's law; and the outer radius of the tube has been taken as 2.2 times the inner. But they give all that is really required, viz., the *character* of the distortion at different points in the wall of the tube.

The next three figures represent the corresponding changes in spherical elements of the same cylindrical tube exposed to pressure from within. All portions of the tube are now extended tangentially and compressed radially, but the amount is greater on each layer as it is nearer the interior surface.

It is now easy to see how it is that a glass tube is broken by the application of pressure from without. The effect is, of course, produced first at the interior surface. For the compression is the same for every portion of the glass, but it is

accompanied by shear, which increases towards the inner surface; and it is probably the resulting extension which produces the effect. But when a tube is exposed to

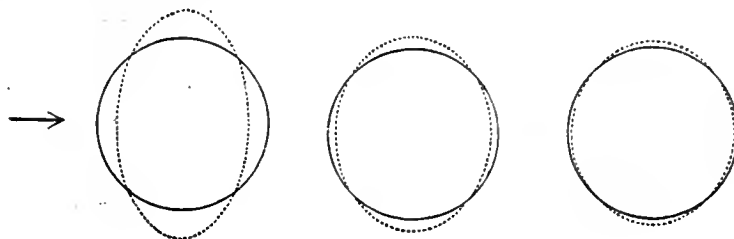

pressure from the interior there is dilatation of the walls, which aids the shear. Thus we see why a thin tube is so much more capable of resisting external than internal pressure. It is probable that, in the case of glass, the element which first gives way is not so much crushed as torn asunder. If so, the tube which is compressed from without is in a much more favourable condition for resisting than that in which the pressure is applied internally. For, in the first, the whole substance of the walls is compressed, and thus the linear extension produced by the shear is in part counteracted. In the second, the whole substance is expanded, and the linear extension due to the shear is aided. As will be seen in Appendix A, the case of very thick tubes is considerably different.

#### *Description of the Apparatus for applying Pressure.*

Sir Wyville Thomson handed over to me, with the thermometers, a press which was made for him before he started in the Challenger, and which he had carried all round the world; but when we made some preliminary experiments with it, we found it to be objectionable in many ways. It was in the first place not safe at high pressures, although an attempt had been made to strengthen it by surrounding it with massive rings of Swedish iron. As the experiments had to be conducted in College, and to a great extent by students who volunteered their services, this was a fatal defect; though I believe that the danger from the bursting of a hydrostatic press has been usually very much exaggerated. The bursting of the cylinder itself would probably be unattended with danger; but some of the nuts and connecting pieces had occasionally been projected with great violence.

A slight numerical calculation shows that a cubic foot of water at a pressure of one ton weight to the square inch is capable of doing only about 1210 foot lbs. of work in expanding, the reason being that although the pressure is intense, the amount of compression it produces is exceedingly small. But a cubic foot of air at a pressure of a ton weight to the square inch is capable of doing nearly 1300 times as much work in expanding. Hence the danger of having large quantities of air in the press before the compression is begun.

Another defect of the apparatus was the comparatively small interior bore, which did not admit of the proper carrying out of my scheme for measuring pressures—



the Bourdon gauge having shown itself quite untrustworthy. Besides, two thermometers, at most, could be exposed to pressure simultaneously, even when no gauge was inserted along with them.

The apparatus which Sir Wyville Thomson finally obtained from the Woolwich gun factories, through the intervention of the Admiralty, was in fact a Fraser gun with a few adaptations made to suit it to the purposes of the investigation. The gun, which is shown in the Plate, on a scale of one-eighth the full size, was made of a cylinder of mild steel, round which were shrunk two successive wrought-iron coils. The effective interior is  $4\frac{1}{2}$  inches in bore, and nearly 4 feet long.

This cylinder was guaranteed to be safe under pressures up to 18 or 20 tons weight per square inch, and we have for various purposes already worked up to pressures of 11 and 12 tons. [The official memorandum concerning this apparatus is given in Appendix D.]

The rest of the apparatus, to fit it for our immediate purpose, consisted of a

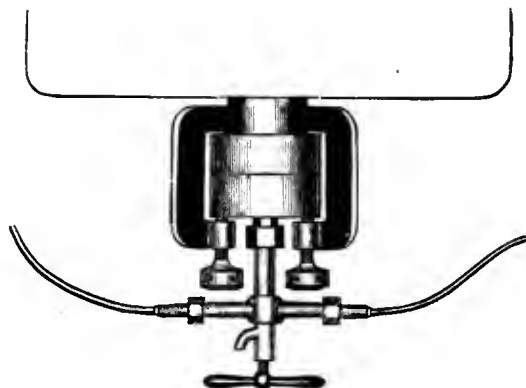

tightly-fitting steel plug which was forced into the upper end of the cylinder after the thermometers and other apparatus had been inserted, and the whole had been filled with water. The plug was forced down by the weight of an assistant standing on it, while a stop-cock at the bottom of the cylinder was kept open for the escape of water, until a massive steel key could be put in through a slot in the side of the cylinder to lock the plug in its definite position.

To the lower end of the steel cylinder was adapted a series of fittings by means of which it could be connected with a powerful force-pump, and simultaneously with a gauge whose construction will be afterwards described. The gauge enabled the experimenters to know at every stage of the operation what amount of pressure had been reached in the interior of the cylinder. The pump was worked at first by hand. Of late a more powerful pump has been procured, and it can be fitted when necessary to the gas-engine of my laboratory.

Only one real difficulty was met with in working this apparatus; viz., the difficulty of making the plug fit perfectly tight. At first, when it came from Woolwich, the

plug was finished by a piece of leather in the form of a cup; but this was found to leak seriously even at very moderate pressures, so that the comparatively small pressure of a ton weight per square inch was unattainable.

But by taking off the leather from the plug and furnishing it with a ring of steel turned into cup form with an exceedingly thin and sharp edge, on the same principle as that on which the piston of the pump was constructed, this difficulty was completely got over. The flexible steel edge was pressed against the interior of the tube more forcibly the greater the applied pressure, and it was found that the apparatus was then, except under the most unfavourable circumstances, perfectly tight, at least so far as the plug was concerned. Very great care was, however, requisite in cleaning the plug and the upper part of the bore of the cylinder before each experiment. The smallest fragment of cotton-waste, getting behind the edge of the cup, almost invariably produced serious leakage when high pressure was applied. The cup form was objectionable for one reason, that it always took down a considerable quantity of air, of which it was impossible to get rid. This difficulty was overcome by putting into the cup a quantity of tallow which completely filled it up and projected considerably below it, so that the apparatus, when pressure commenced, contained at the most a few small air bubbles only.

Later, when I found it was impossible to obtain certain necessary data, on account of the slowness with which pressure was got up in so large an apparatus, I procured a very much smaller apparatus of similar character, in which the cylinder was only an inch in bore, and rather less than a foot in effective interior length. With this apparatus two or three strokes, only, of the pump were required to get up the desired pressure, and there was the great additional advantage that temperatures could be independently measured by means of thermo-electric junctions. [This could not be done in the large cylinder without seriously affecting its strength, and rendering it at the same time almost unmanageable.]

#### *Accurate Measurement of great Pressures.*

It will be obvious from what has been said, especially as regards the old apparatus which was carried about in the Challenger, that one of the most essential requisites of the whole investigation was the accurate measurement of pressure. All the ordinary forms of pressure-gauge were found to be untrustworthy. It was necessary that in all cases the pressure should be measured with certainty to about 1 per cent. No attempt was made to secure any greater degree of accuracy, as the indications of the thermometers themselves could not in any case be trusted to less than  $0^{\circ}.1$  Fahr. It is a vain but too common custom to try to make some parts of an experimental measurement exact to a greater degree than can possibly be attained in the rest. But it is mere waste of time.

The basis on which, after a great many trials, I finally founded my determination of pressures, was Amagat's<sup>1</sup> remarkable measurements of the volume of air and other

<sup>1</sup> "Mémoire sur la compressibilité des gaz à des pressions élevées, par M. E.-H. Amagat" (*Ann. de Chimie et de Physique*, 1880).

Scale  $1\frac{1}{2}$  inch = 1 ft

Fig. 1.

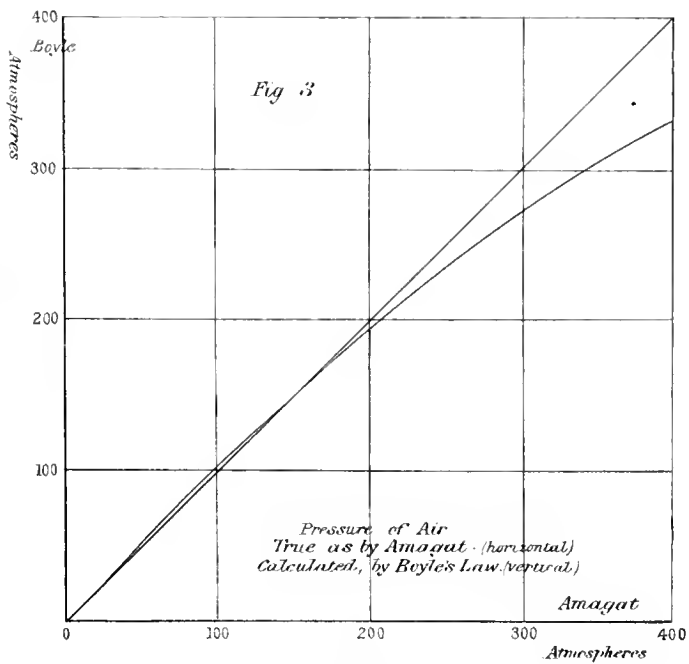
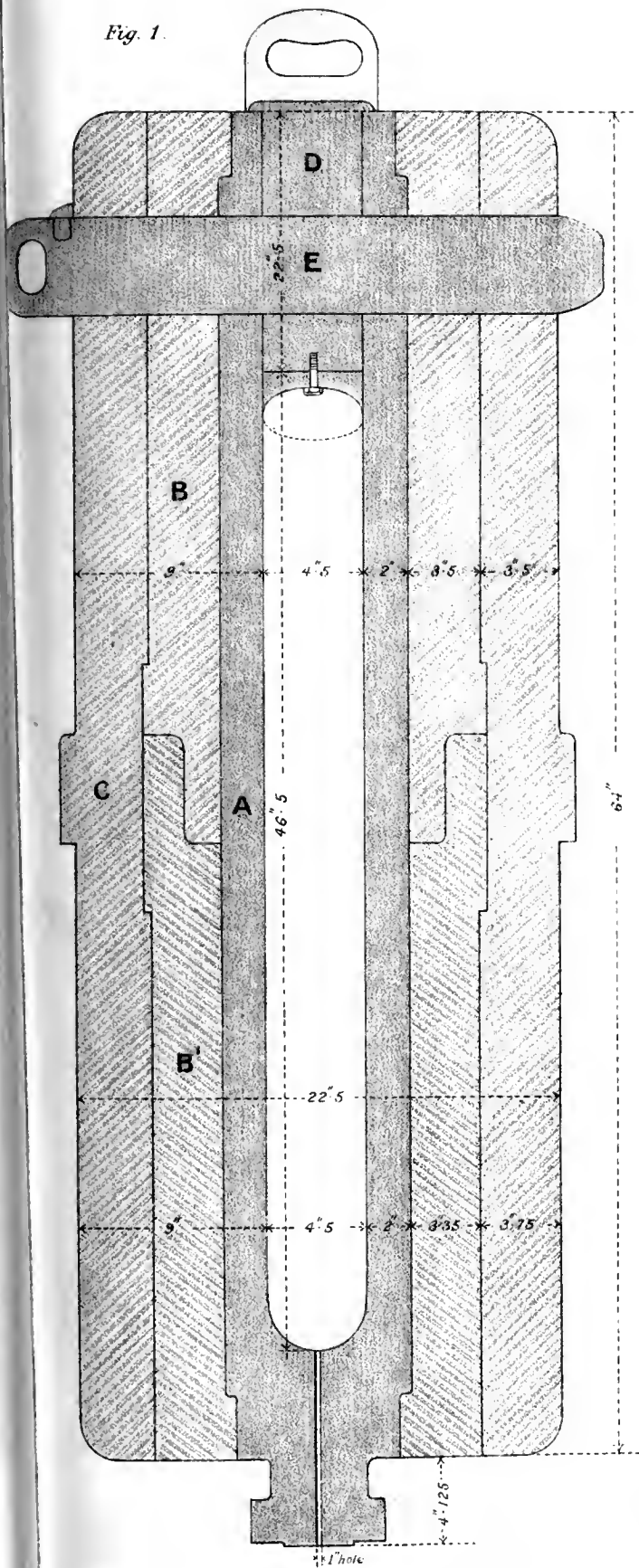

Scale  $\frac{3}{4}$  inch = 1 ft

Fig. 2.

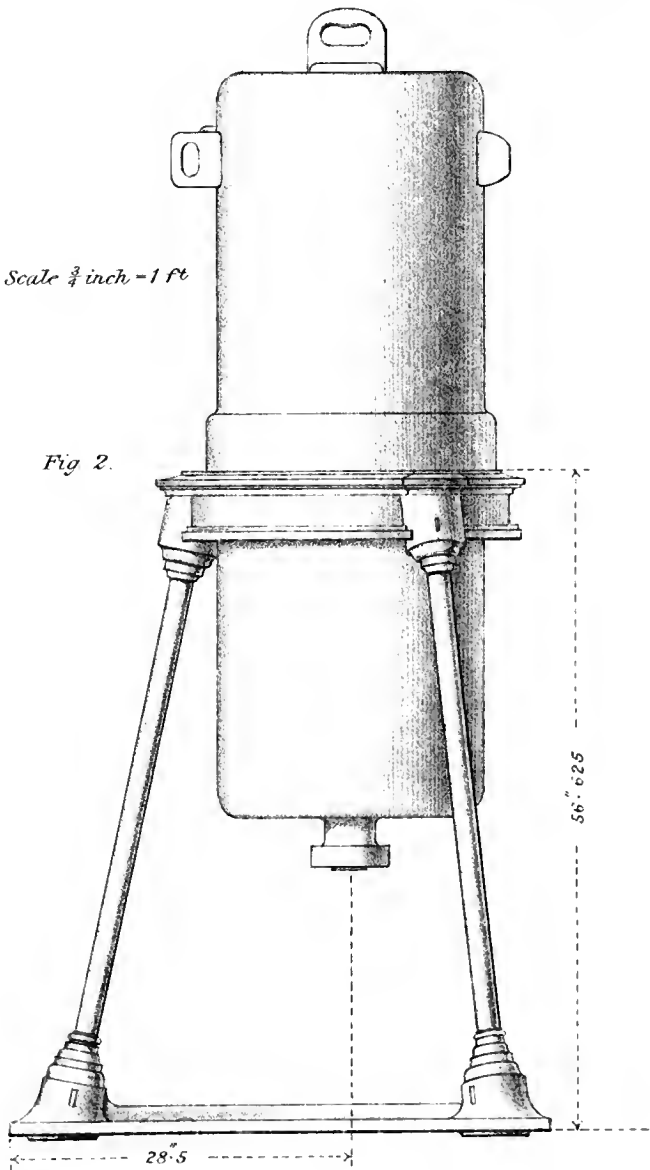



gases at high pressures. Amagat's data were obtained in the most direct and satisfactory manner, inasmuch as he measured his pressures by means of an actual column of mercury extending sometimes to 300 metres, and more. All other means of measuring pressure are as it were valueless in comparison with this. We know by these experiments the compressibility of nitrogen, and of air, up to pressures of at least  $2\frac{1}{2}$  tons weight per square inch, with almost all desirable accuracy.

All that was necessary therefore in order to determine the pressures in the operating cylinder, and thus to calibrate the gauges employed, was to compress once for all a quantity of air, measure the volume to which it was compressed and the corresponding indications of the gauges, and then by the help of Amagat's tables compute the pressure actually attained. The apparatus I employed for this purpose is figured in section in the diagram below.

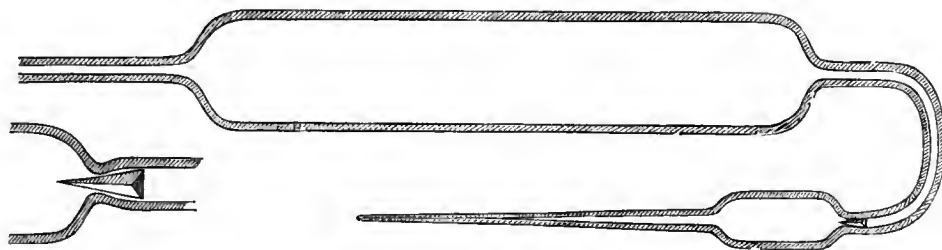

This apparatus, filled with dry air, was allowed to come exactly to the temperature of the water inside the compression apparatus; then, the lower end of it being dipped into a large vessel of mercury, it was let down full of air into the compression cylinder and pressure was applied. The effect was of course to compress the air, force up the mercury until it gradually filled the vessel and forced the air entirely into the smaller bulb. After a few trials we found roughly what amount of pressure was necessary in order just to commence the forcing of mercury into the small bulb. The mercury forced in was weighed; then the capacity of the small bulb was determined by weighing its content in mercury. The difference of these weights is the weight of mercury, which would occupy the same volume as did the air when compressed. Finally, the original volume of the air was found by weighing the whole apparatus, first empty, then filled with water; and, most important in view of Amagat's results, the barometer and thermometer were carefully observed at the instant when the apparatus had its lower end placed in the vessel of mercury. Mr Kemp, who made these instruments for me, suggested and carried out the great improvement of inserting a small triangular pyramid of glass into the choked part of the bore (as shown in the small sketch). The effect is to break the mercury (which must be very clean) into exceedingly small drops. In this way the actual compression of the air was determined with a limit of error, represented at the utmost by the ratio of the volume of one of the small drops of mercury formed at the obstruction to the whole capacity of the small bulb. By working simultaneously with three instruments of this kind, even this very small error could be in great

part eliminated:—and, practically, the compressions were measured far more accurately than was at all necessary for the purpose in hand. For greater accuracy a larger apparatus would be required. This, however, was quite unnecessary. And the requisite limit of accuracy in the experiment rendered it unnecessary to correct for the alteration of volume of the smaller bulb consequent on the pressure to which it was subjected.

In my later experiments a long carefully-gauged tube of 1.5 mm. in bore was substituted for the small bulb. This tube was coated internally with an excessively thin film of metallic silver thrown down by sugar of milk. The process was arrested the moment the film became visible by reflection. This film is at once dissolved by the mercury up to the point which it reaches at the greatest pressure, and leaves a perfectly sharp and nearly opaque edge from which to measure. This device has proved so very successful that I have now substituted it for the indices in all the pressure gauges (shortly to be described) which are employed for very accurate measures. And I am at present engaged in measuring, by comparison of a glass gauge and an air gauge both fitted in this manner, the compression of various gases at pressures up to fourfold those applied by Amagat.

#### *Internal Pressure Gauges.*

The next step was to find some plan of construction for an instrument which, having its scale determined once for all by comparison with the air-gauge, should ever afterwards serve instead of it, thus affording a ready measure of pressure. Liquids are obviously better fitted for this purpose than solids, if only on account of their absolute homogeneity and their greater compressibility. But, unfortunately, *two* liquids must be employed, since a record must be kept:—the apparatus being surrounded on all sides by 9 inches of iron:—and, as will be seen in Appendix E, all my trials with two liquids were more or less unsatisfactory. The very fact that I was dealing with thermometers whose bulbs were protected from pressure, at once suggested an unprotected thermometer as something perfectly well suited to the purpose so long as the glass might be trusted to follow Hooke's law. [I have since found that the invention of such an instrument, to be used as an *étatéromètre*, is due to Parrot.<sup>1</sup> His investigation of the effects of pressure is wholly incorrect, as it takes no account of distortion; but the device, and the recognition of the fact that its indications are proportional to the pressure, are wholly his.]

These instruments, which, like the thermometers, are fitted with a needle-index with hairs attached, have only one defect, which is that they act like thermometers as well as pressure gauges. That defect I managed to remove almost completely by

<sup>1</sup> "Expériences de forte compression sur divers corps, par M. Parrot" (*Mémoires de l'Académie Impériale des Sciences de St Petersburg*, 6me Série, tome ii., 1833). The pages are headed "Parrot et Lenz," and it was by mere accident (seeking in the Royal Society's *Catalogue of Scientific Memoirs* for a reference to Lenz's thermo-electric writings) that I lit on the paper. I was much surprised at some of the statements it contains, till I found at the very end a footnote by Lenz, in which he disclaims all responsibility for the writing of the paper, and for the conclusions drawn in it.

the simple device of enclosing in the bulb a closed glass tube which *all but* fills it. The liquid then occupies only a small space between the interior tube of glass and the exterior tube forming the bulb, and is as ready as ever to give indications of pressure, while it is not in sufficient volume to be more than slightly disturbed even by a serious change of temperature.

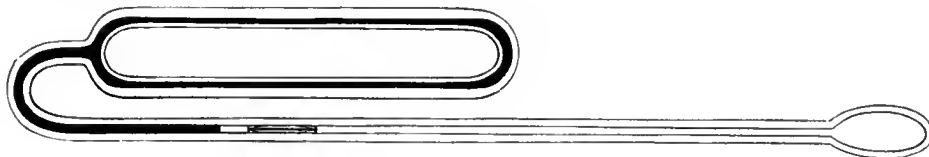

As will be seen in Appendix A to this paper, it is quite easy, by comparing two instruments of this kind in which the ratios of the internal to the external radius of the cylindrical bulb are different, to find by trial through what range its indications are strictly proportional to the pressure. Thus all the requisites of a perfect gauge, so far as the experiments required, were met by this simple apparatus. That I have obtained a sufficient accuracy in the graduation of these instruments is proved by the close agreement between my results for the volumes of air at different pressures as measured by means of them, with the volumes corresponding to these pressures in Amagat's table. If Boyle's Law had been even approximately true for these high pressures, this mode of verification would have been fallacious. It would, however, be easy to make an independent verification, by sinking some of these instruments, each thoroughly imbedded in a mass of lard (as a protection from shocks), to a measured depth in the sea. This idea is worthy of consideration, especially if the gauge be made to register by means of a silvered tube. The only probable cause of error in such a case would be the breaking of the mercury column by a jerk, and to this all other forms are at least equally liable.

#### *External Pressure Gauge.*

But it was necessary not merely to measure accurately the pressure applied, but also, for the sake of the thermometers, to provide that the pressure should not be carried too far; and for that purpose it was indispensable to have an exterior indicator of pressure.

This was furnished by a thin cylindrical steel tube enclosed in a cavity bored in a large block of iron, the interior of the steel tube being full of mercury and the narrow space between it and the large iron block also full of mercury. This exterior space was connected with the pressure apparatus. The pressure then throughout the whole of the space exterior to the steel cylinder was the pressure in the pump. The steel cylinder was therefore compressed from the outside. In the neck of the steel cylinder, which was screwed into the surface of the block, there was luted a vertical glass tube. It was exposed to no pressure, but the mercury in it rose, by the compression of the steel cylinder, and the height to which it rose could be easily

measured. Comparative experiments were made several times by putting one of the glass gauges, whose scale had been carefully ascertained, inside the apparatus, while

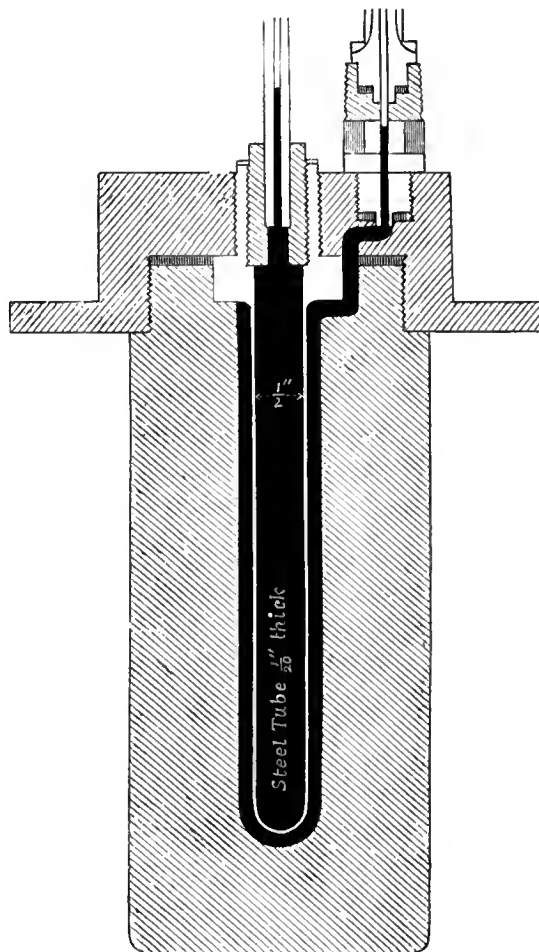

this newly-described gauge was also connected with it. In this way the external gauge was accurately calibrated. But, lest an accident should happen to one of the gauges, or to its index (as sometimes was the case) no experiment was made without the presence of at least three gauges. The way in which these worked together during the whole course of the experiments is the best possible proof of their value. This form of gauge, also, is greatly improved by inserting a glass tube (closed at both ends) into the bulb; for the temperature changes produced by pressure in mercury are greater than those in water at ordinary temperatures.

*Results of the Experiments. The true correction for pressure is very small.*

Having described the apparatus I proceed to the results. As soon as I applied pressure to the Challenger thermometers I found I reproduced pretty nearly the



results obtained by Captain Davis. I had already seen one proof that at least a large part of the result was in all probability not due directly to pressure. The experiment with the long thermometer tube showed that my theoretical calculations had been correct. The question thus became:—Is this a pressure effect of any kind; and, if so, how does it originate? and if it is not a direct pressure effect, to what is it due? There are many ways of answering such questions. One answer was furnished by one of the thermometers (A 3), whose degrees (especially on the maximum side) are very short. The whole effect (in degrees) on this thermometer was not very markedly greater for a given pressure than on the others, as it would certainly have been had the effect been entirely due to pressure directly. Another is, if it be not a direct pressure effect it must be a heating effect. With Sir Wyville Thomson's permission I got from Mr Casella, the maker of the Challenger thermometers, a couple of others of exactly the same form and dimensions, but with the bulbs plugged after the manner of the gauges already described, so as to diminish their susceptibility to changes of temperature. When I put one of these into the pressure apparatus along with one of the Challenger thermometers, I found the effects on the new form very much smaller than on the old. Thus it was at once proved that the effect could not be due to wry-neckedness produced by the fitting on of the protecting bulb; which would have been an effect due to pressure directly: but that it must be an effect due to heat. That is to say, it was now completely established that the large results obtained by Captain Davis are due in the main to causes which can produce no effect when the thermometers are let down gradually into the deep sea; they are due to causes connected with the thermometers, and perhaps also with the pump, but solely under the circumstances of a laboratory experiment.

*Sources of the large effect obtained in the Press.*

Now comes the question (no longer important to the Challenger work, but of great scientific interest), What are these various sources, and how much of the effect is due to each? First of all we have seen that the water in the press is heated when pressure is applied. Using Sir William Thomson's formula I found the amount of that heating should be about  $0^{\circ}05$  F. at  $43^{\circ}$  F.,  $0^{\circ}16$  at  $50^{\circ}$ , and only  $0^{\circ}3$  at  $59^{\circ}$ , for one ton of pressure. [These numbers, as will be seen in Appendix B, are rather too small. We do not yet know to what extent the temperature of the maximum density point of water is lowered by pressure.] These cannot be expected to be fully shown under the circumstances of the experiments, and even if they were fully shown the greatest of them represents only about one-half of the whole of Captain Davis' result; there must therefore be some other cause.

I next thought of the heat produced by pumping water into the pressure vessel. That vessel, as is shown in the cut, is connected to the pump by means of a long narrow tube of copper, leading to another long narrow tube in the lower end of the vessel. These tubes were from  $\frac{1}{16}$ th to  $\frac{1}{10}$ th inch in bore, and nearly three feet in length. To estimate roughly the heat developed by the pumping, I calculated that

about 300 strokes of the pump had to be made in getting up a pressure of about three tons, each stroke through about 2 feet, and with a mean or average pressure of about 20 lbs. weight. If the whole work done in that way had been expended in heating the water, the temperature effect would have been about  $0^{\circ}5$  F., as it was due to 12,000 foot lbs. of work done on about 30 lbs. of water. But this is an overestimate, and besides a very large portion of the heat actually developed is given to the pump and the connecting tubes, and much of the rest is at once conducted away by the walls of the massive cylinder, and thus the rise of temperature due to this cause is exceedingly small.

The direct compression of the thermometer tubes already referred to accounts for on the average about  $0^{\circ}25$  F. per ton pressure, so that there is still a considerable part of the whole result to be accounted for. I saw at once that it must be due in part at least to the glass protecting bulb, and perhaps also in part to the vulcanite on which the thermometers are mounted. In order to verify the latter hypothesis I took one of the Challenger thermometers and embedded the bulb of it (protecting case and all) in a mass of lard. I was sure the lard would act as a perfectly plastic body under these great pressures, and so could do no harm to the bulb. The result far more than answered my expectations, because by a pressure of not more than 3 tons the effect on the lard-covered thermometer was over  $5^{\circ}$  F.

This showed me at once that we were working in a new sort of world, where all things had properties very different from those they show under ordinary pressures, and therefore I began to think it possible that the vulcanite might have a large share in the residual effects.

In order to test the point I took one of the Challenger thermometers on which I had already made numerous concordant experiments, and removed it from its vulcanite sheath. After replacing the scale, I performed with it exactly the same experiments as before. The result was unmistakable. The effect of pressure was notably diminished by the absence of the vulcanite. This is a source of error which may differ greatly in efficiency in the different thermometers, according to the quality of the vulcanite and its exact position relatively to the protected bulb.

The remaining part of the error, due to distortion of the glass protecting bulb, has given me much more trouble than all the others together. Its amount cannot be calculated, so far as I know, for it is a case of shear and compression combined, whereas in the case of vulcanite it was a pure compression. I made some determinations, however, by opening the protecting bulb, and substituting mercury and other liquids, and sometimes air alone, for the alcohol which it originally contained. The general conclusion from such experiments was, that a small amount of the whole observed effect is due to the glass protecting bulb.

To make this more certain I surrounded the protecting bulb with a test tube filled with pounded glass, and I found the heating of this glass by compression, in spite of the heating of the glass of the protecting bulb, produced a decided increase in the observed rise of temperature.

Thus it appears that there are no less than five different causes which contribute each its share to Captain Davis' result. Of these, one is independent of the others, and would produce its full effect even if they were not present. The other four give effects which are not cumulative, and it would be very troublesome to try to assign to each its exact share of the result when two or more act together. Fortunately, it will be seen that we do not require to attempt to solve this problem.

(1) First is the direct effect of the external pressure upon the exposed part of the thermometer tubes. This, in general, will be found very small, except in tubes where there are large aneurisms. The whole effect of 3 tons pressure on a Challenger thermometer without aneurisms, at temperatures near freezing point, so far as the minimum index is concerned, would be only about 3 one thousandths of 30 degrees or so, that is 90 thousandths or at most 0.1 of a degree for 3 tons pressure. That is an amount which, in consequence of the necessary errors of reading the thermometers, may be entirely neglected, and, unless there are large aneurisms, there will be little need for pressure corrections even in six miles of sea.

The other parts of the observed effect were

(2) Heating of water. This I observed to follow very nearly, according to Thomson's formula, the original temperature of the water. By comparing the pressure effects on the same thermometers during summer, and during winter (for which latter the late continued frost was of particular service, and enabled me to work for many days at the temperature of the maximum density of water), I found the results to vary in accordance with calculation.

(3) Heat due to friction during pumping. This from its very nature was unavoidable unless we could have got an apparatus into which (by enormous pressure) the plug could have been forced directly. This could not, however, have been done in my laboratory, even if the apparatus had been adapted to such a form of experiment. But it was very easy to calculate the extreme possible amount of this effect.

(4) The peculiar heating effect due to the vulcanite mounting. I verified this effect of vulcanite by taking a thermometer which had no vulcanite about it and measuring the effect produced upon it by a definite pressure, and then putting loosely round the bulb (in a test-tube, which had itself been previously experimented on) a small quantity of vulcanite in thin plates. I found that so little as 8 grammes of vulcanite round the protecting bulb raised the effect produced by a pressure of 3.2 tons weight from 0°.5 F. to 1°.1 F. The vulcanite was in thin strips about a millimetre and a half in thickness. The effect of the vulcanite on the Challenger thermometers (in the hydrostatic press) must, from the mode of their construction and mounting, in all cases be considerably greater than this.

Under these circumstances, we might without farther inquiry fairly attribute the whole outstanding effects to the massive vulcanite slabs on which these thermometers are framed. But there still remains

(5) The most difficult question of all, the temperature effect produced by pressure upon the protecting bulb, which is under different circumstances altogether from the

vulcanite; for the vulcanite is simply compressed, while the glass sheath is under pressure on one side and not on another, and is therefore subject to shear as well. In its interior the glass is extended in a radial and compressed in a tangential direction. Nobody has yet made any approximation to an answer to the question what effect in the way of heating or cooling will be produced by deformation which consists partly of compression and partly of change of form. We know that in indiarubber a cooling effect is produced by traction, and it may happen that a similar change of form in glass also produces a reduction of temperature. This is a question, however, which is not capable of answer by the help of my present apparatus;—though it will probably be answered by experiment before theory is able to touch it. The results of my experiments on the thermometers with plugged bulbs show that, on the whole, a heating effect results from the combined compression and shear in a bulb exposed to external pressure only. This has been verified by cutting down a thermometer, an exact counterpart of the Challenger thermometers but without aneurisms, taking out the greater part of the mercury and inserting a second (now a maximum) index in the minimum side of the tube. When this instrument was stripped of its vulcanite, the effect of pressure at 40° F. was considerably greater than that due to compression of the tube.

But it does not require to be taken into account so far as the Challenger thermometers are concerned.

#### *Final Conclusion from the Investigation.*

The final conclusion is that only one of these five causes, which are active in the laboratory experiment, can affect the Challenger thermometers when let down into the sea, namely, pressure. There is there no heating of water by compression; there is no heating by pumping; there is no heating of vulcanite, because the thermometers are let down so quickly that the water which surrounds them is rapidly changed, and thus each little rise of temperature is at once done away with as the thermometer passes through a few additional yards. For the same reason, also, the effect on the protecting glass, which is a heating effect on the whole, is all but done away with step by step as it is produced. All these four causes, therefore, which made Captain Davis' correction so much too large, are valid only for experiments in a laboratory press, and not for experiments in the deep sea. Therefore, as a final conclusion, I assert that, if the Challenger thermometers had had no aneurisms, the amount of correction to be applied to the minimum index would have been somewhat less than 0°·05 F. for every ton of pressure, *i.e.*, for every mile of depth. All the thermometers which have large aneurisms have had special calculations made for them, but in no case does the correction to be applied to the minimum index exceed 0°·14 or about  $\frac{1}{7}$ th of a degree per mile of depth. [The results of the special calculation for each thermometer are given in Appendix E. These refer to temperatures about 50° F.; for lower temperatures somewhat less correction is necessary, as the part of the tube to which the effect is due is then a little shorter.]

Various singular results were met with in the course of the experiments, especially in connection with the crushing (in some cases) or the explosion (in others) of one or two of the thermometers. In one of these cases the copper tube surrounding the instrument was considerably distorted. I learn that the same thing occurred to the copper sheaths of the thermometers which were crushed in deep water during the Challenger voyage. The explanation of this occurrence will be found in Appendix D, to which I refer for the description of other singular phenomena observed during the course of the inquiry.

The preliminary experiments connected with this investigation were carried on mainly by students working in my laboratory, but all the experiments on which the preceding conclusions were founded were carried on by myself with the very efficient assistance of Mr R. T. Omond and of my assistant Mr Lindsay. I have been singularly fortunate in having at hand the mechanical skill of Mr Chalmers and the glass-blowing skill of Mr Kemp. To these able artificers I am indebted for the prompt and thorough manner in which they have executed the various novel forms of apparatus required in the course of this protracted investigation.

## APPENDICES.

## APPENDIX A.

## ON THE ACCURATE MEASUREMENT OF HIGH PRESSURES.

[Mainly from *Proceedings of the Royal Society of Edinburgh*, 1879—80.]

IN the course of an examination of some of the Challenger deep-sea thermometers, I have recently had occasion for measurements, accurate to one or two per cent., of pressures such as five or six tons weight per square inch. The ordinary gauges showed themselves to be quite untrustworthy, and it was necessary to devise some plan of whose accuracy the experimenter can feel assured. The following process has proved completely successful, and is capable of any desired degree of accuracy.

Simple methods based on the compression of gases, such as air or nitrogen, are of the highest value wherever they can be adopted; for the law of compression of these bodies is known with great accuracy (at least for one definite temperature) from the measurements recently made by Amagat, in which the pressures were directly reckoned in terms of a column of mercury. A simple form of gauge, in which the column of mercury compressing the gas into a small bulb at the extremity is made to break off at a constriction in the connecting tube, enabling us (by weighing the mercury forced over into the bulb) to measure the compression very accurately, suffices amply for all pressures up to a ton weight per square inch, or even farther.

But this instrument becomes rapidly less and less sensitive at higher pressures; so that, though the law of compression for a considerably extended range is now known, for pressures above a ton something else is required. Besides, this method is very laborious, and therefore is not to be employed oftener than is absolutely necessary.

Hooke's Law now comes to our assistance. An instrument resembling a thermometer in form supplies the next step. Its bulb is all but filled by a glass tube closed at each end, and it is thus practically unaffected by the changes of temperature produced in such experiments. Over the mercury in the stem is a long column of alcohol in which the index moves, and the rest of the tube contains alcohol vapour only. The bulb is made cylindrical for several reasons; the chief being to secure uniformity of thickness, which is practically unattainable (or at least unverifiable) in a sphere. By properly choosing the thickness of the cylinder in proportion to its bore, and its volume as compared with that of an inch of the fine tube, the sensitiveness of this gauge may be made as great or as small as we please. And, by employing two or more, with bulbs of nearly the same internal dimensions, but differing considerably from one another in the thickness of the cylindrical walls, a very important advantage is secured. For, under the same pressure, the maximum amounts of distortion of the glass are greater in the thinner bulbs, and thus these begin to deviate from Hooke's Law at pressures under which the thicker ones are still following it accurately. Thus, by comparison, we can easily find through what portion of its range each instrument gives effects strictly proportional to the pressure. The thinnest of these has the unit of its scale determined by comparison with the nitrogen gauge.

When this method has to be extended to pressures such as would crush glass, recourse must be had to steel. A number of steel instruments, in their turn, can have their scale units determined accurately from one another, each from a thinner one; until we come to the thinnest, whose unit is exactly found by comparison with one of the thicker of the glass instruments. We have thus a series of gauges, each of any desired sensitiveness, capable of reading accurately pressures up to those for which steel at the interior of a thick tube ceases to follow Hooke's Law.

To illustrate this process, and to show what amount of sensitiveness is to be expected from an instrument of known dimensions, I append an approximate solution of the problem of the compression of a cylindrical tube with rounded ends. The exact solution would be very difficult to obtain, and would certainly not repay the trouble of seeking it. I content myself, therefore, with the assumption that all transverse sections are similarly distorted; which, of course, involves their continuing to be transverse sections.

Let  $\xi$  denote the displacement of a transverse section originally distant  $x$  from one end, and let  $\rho$  be the change of  $r$  the original distance of any point of the section from the axis. Then, as it is obvious that the principal tractions are along a radius, parallel to the axis, and in a direction perpendicular to each of these, we have at once\*

$$\frac{d\rho}{dr} = et_1 - ft_2 - ft_3, \quad \frac{\rho}{r} = -ft_1 + et_2 - ft_3, \quad \frac{d\xi}{dx} = -ft_1 - ft_2 + et_3,$$

where

$$e = \frac{1}{3n} + \frac{1}{9k}, \quad f = \frac{1}{6n} - \frac{1}{9k}.$$

Here  $\frac{1}{k}$  is the compressibility, and  $n$  the rigidity, of the material of the tube.

In addition we have for the equilibrium of an element bounded by coaxal cylinders, planes through the axis, and planes perpendicular to it,

$$t_2 = \frac{d}{dr}(rt_1);$$

and the approximate assumption above gives  $\frac{d\xi}{dx} = \text{constant}$ .

From these five equations  $t_1$ ,  $t_2$ ,  $t_3$ ,  $\rho$ , and  $\xi$  are to be found.

They show that  $t_3$  is constant, and its value must therefore be  $-\Pi \frac{a_1^2}{a_1^2 - a_0^2}$ ; where  $\Pi$  is the pressure, supposed to be wholly external.

With the surface conditions,  $t_1 = -\Pi$  when  $r = a_1$ ,  
 $t_1 = 0$  ,,  $r = a_0$ ,

we determine the arbitrary constants, and it is easy to see that

$$\begin{aligned} (a) \quad \frac{\rho}{r} &= -\Pi \frac{a_1^2}{a_1^2 - a_0^2} \left( e - 2f + \frac{a_0^2}{r^2} (e + f) \right) = -\Pi \frac{a_1^2}{a_1^2 - a_0^2} \left( \frac{1}{3k} + \frac{a_0^2}{r^2} \frac{1}{2n} \right), \\ (b) \quad \frac{d\rho}{dr} &= -\Pi \frac{a_1^2}{a_1^2 - a_0^2} \left( e - 2f - \frac{a_0^2}{r^2} (e + f) \right) = -\Pi \frac{a_1^2}{a_1^2 - a_0^2} \left( \frac{1}{3k} - \frac{a_0^2}{r^2} \frac{1}{2n} \right), \\ (c) \quad \frac{d\xi}{dx} &= -\Pi \frac{a_1^2}{a_1^2 - a_0^2} (e - 2f) = -\Pi \frac{a_1^2}{a_1^2 - a_0^2} \frac{1}{3k}. \end{aligned}$$

\* Thomson and Tait, *Nat. Phil.* §§ 682, 683.

These quantities express the change per unit of length: (*a*) tangentially to a cross-section of radius *r*; (*b*) radially for the same section; and (*c*) longitudinally for all parts of the tube. They indicate a strain made up of two parts: a uniform compression of

$$\frac{\Pi}{3k} \frac{a_1^2}{a_1^2 - a_0^2}$$

in all directions; and a shear of  $1 \pm \frac{\Pi}{2n} \frac{a_1^2}{a_1^2 - a_0^2} \frac{a_0^2}{r^2}$

in the plane of a transverse section.

The diminution per unit volume of the interior of the cylinder is

$$-2 \left( \frac{\rho}{r} \right)_{a_0} - \frac{d\xi}{dx} = \Pi \frac{a_1^2}{a_1^2 - a_0^2} \left( \frac{1}{n} + \frac{1}{k} \right).$$

When  $\Pi$  is a ton-weight per square inch, the value of the quantity

$$\Pi \left( \frac{1}{n} + \frac{1}{k} \right)$$

is, according to the best determinations, somewhere about  $\frac{1}{10000}$  for ordinary specimens of flint glass, and about  $\frac{1}{1000}$  for steel. This expression is very simple, and enables us at once to calculate the requisite length of bulb, when its internal and external radii are known, which shall have any assigned sensitiveness when fitted with a fine tube of a given bore. To obtain great sensitiveness, increasing the diameter of the bulb is preferable to diminishing its thickness, as we thus preserve its strength; and we have seen how to avoid the complication of temperature corrections.

It is obvious from the expressions above that the change of unit volume is the same throughout the whole of the substance of the walls of the tube, having the value

$$-\frac{\Pi}{k} \frac{a_1^2}{a_1^2 - a_0^2}.$$

But the shear is greater as *r* is less. Its greatest value is therefore at the interior surface, where it is

$$1 \pm \frac{\Pi}{2n} \frac{a_1^2}{a_1^2 - a_0^2}.$$

It is here that the tube first gives way to pressure, and it does so probably because of radial extension. For the expression (*b*) above, is, for glass, numerically per ton of pressure

$$-\frac{a_1^2}{a_1^2 - a_0^2} \left( \frac{1}{8100} - \frac{a_0^2}{r^2} \frac{1}{3200} \right).$$

This vanishes, or there is no radial compression, whatever be the external pressure, when

$$r = \frac{9a_0}{4\sqrt{2}} = 1.6a_0, \text{ nearly,}$$

as stated in the text above. It is worthy of notice that this expression is independent of  $a_1$ , and thus that, in all tubes, if the outer radius exceeds the inner at least in the proportion of 1.6 : 1, there is a cylindrical element whose thickness is not diminished by compression, and its radius is in all cases 1.6 times that of the inner bore. For all values of *r* less than this there is radial extension, and its utmost value is at the inner surface, where for



$T$  tons pressure it amounts per unit of length to about

$$\frac{T}{5300} \frac{a_1^2}{a_1^2 - a_0^2}.$$

From some experiments made for the purpose, I find (*Proc. R.S.E.*, 1881) that ordinary lead glass gives way when the shear is about  $1 \pm \frac{1}{230}$  (coupled with  $\frac{1}{230}$ th of compression in all directions). It is not clear whether it is the shear or the mere radial extension (in this case  $= \frac{1}{370}$ ) under which the glass yields. This question is of importance when we consider internal pressure. At any rate, it follows that no tube (of this kind of glass), however thick, can stand more than about 14 tons external pressure. [The calculations here given are, of course, based on the assumption that glass accurately follows Hooke's Law until it gives way. This is certainly not quite exact, but we do not yet know the amount of the deviation. I hope to approximate to it by the comparison of gauges of different thickness. But the true effects cannot largely differ from those based on the assumed generality of Hooke's Law.]

When the pressure is internal we have

$$\frac{\rho}{r} = \frac{\Pi a_0^2}{a_1^2 - a_0^2} \left( \frac{1}{3k} + \frac{a_1^2}{r^2} \frac{1}{2n} \right), \quad \frac{d\rho}{dr} = \frac{\Pi a_0^2}{a_1^2 - a_0^2} \left( \frac{1}{3k} - \frac{a_1^2}{r^2} \frac{1}{2n} \right), \quad \frac{d\xi}{dx} = \frac{\Pi a_0^2}{a_1^2 - a_0^2} \frac{1}{3k};$$

whence the corresponding conclusions may be drawn. In particular, the increase per unit volume of the substance of the tube is

$$\frac{\Pi}{k} \frac{a_0^2}{a_1^2 - a_0^2};$$

which, in thick tubes of small bore, is very small compared with the compression produced by the same pressure applied externally. Also the increase per unit volume of the interior is

$$\frac{\Pi a_0^2}{a_1^2 - a_0^2} \left( \frac{1}{k} + \frac{a_1^2}{a_0^2} \frac{1}{n} \right).$$

In very thick tubes of narrow bore this is roughly  $\frac{\Pi}{n}$ , the value of which in glass is about  $\frac{1}{1300}$  only for one ton pressure. Also, according to the two separate hypotheses above, the utmost internal pressure which a tube of common lead glass can stand is either  $8\frac{1}{2}$  or 14 tons. If it breaks by shearing alone, it is equally resisting to external and internal pressures; if by mere extension, it resists external pressure more than internal in the proportion of about 5 : 3.

When the pressure is the same outside and inside the cylinder, we have

$$\frac{\rho}{r} = -\frac{\Pi}{3k}, \quad \frac{d\xi}{dx} = -\frac{\Pi}{3k},$$

and the diminution per unit volume of the interior is, as in Örsted's experiment,

$$\frac{\Pi}{k}.$$

The value of this in flint glass is, for one ton pressure, about  $\frac{1}{2700}$ .

When there are, simultaneously, pressures  $\Pi_1$  external and  $\Pi_0$  internal, we have

$$\frac{\rho}{r} = \frac{1}{3k} \frac{\Pi_0 a_0^2 - \Pi_1 a_1^2}{a_1^2 - a_0^2} + \frac{\Pi_0 - \Pi_1}{2n} \frac{a_1^2 a_0^2}{(a_1^2 - a_0^2) r^2}, \quad \frac{d\xi}{dx} = \frac{1}{3k} \frac{\Pi_0 a_0^2 - \Pi_1 a_1^2}{a_1^2 - a_0^2};$$

whence the increase of unit volume of the walls is at every point

$$\frac{1}{k} \frac{\Pi_0 a_0^2 - \Pi_1 a_1^2}{a_1^2 - a_0^2},$$

and the shear in the transverse sections

$$1 \pm \frac{\Pi_0 - \Pi_1}{2n} \frac{a_1^2 a_0^2}{(a_1^2 - a_0^2) r^2}.$$

The increase of volume of the interior is

$$\frac{1}{k} \frac{\Pi_0 a_0^2 - \Pi_1 a_1^2}{a_1^2 - a_0^2} + \frac{\Pi_0 - \Pi_1}{n} \frac{a_1^2}{a_1^2 - a_0^2},$$

which agrees with the special results above when  $\Pi_0$  or  $\Pi_1$  is made to vanish.

For a spherical bulb the equations are reduced to

$$\frac{d\rho}{dr} = et_1 - 2ft_2, \quad \frac{\rho}{r} = -ft_1 + (e-f)t_2,$$

$$2rt_2 = \frac{d}{dr} (r^2 t_1),$$

and we have for external pressure  $\Pi$

$$\frac{\rho}{r} = -\Pi \frac{a_1^3}{a_1^3 - a_0^3} \left( \frac{1}{3k} + \frac{a_0^3}{r^3} \frac{1}{4n} \right).$$

As a verification of these formulæ, in addition to the simple one described in the text above, I had an apparatus constructed of ordinary lead glass of the following dimensions:— Length of cylindrical bulb, 745 mm. Ratio  $a_0 : a_1 = 8.7 : 21.9$ . The weight of mercury filling 424 mm. of this bulb was 167 gm. To the bulb was attached a smaller tube of which the mercury filling 68 mm. weighed 1.43 gm.

Hence we have

$$\frac{a_1^2}{a_1^2 - a_0^2} = 1.187.$$

Also the content of the whole bulb in mercury is  $\frac{745}{424} 167$  gm. = 293.4 gm. Hence a pressure of one ton-weight should force into the narrow tube  $\left( \frac{1.187}{1000} 293.4 = \right) 0.348$  gm. of mercury. This ought to displace the index through  $\left( \frac{0.348}{1.43} 68 = \right) 16^{\text{mm}}.55$ . Comparing this with the result of experiment, we had the following remarkably satisfactory numbers:—

Tons.	Calculated.	Observed.
0.9	14.9	14.6
1.4	23.1	21.2
3.1	51.3	48.9

There was no glass tube in the interior of the bulb, so that the slight discrepancies between the several ratios of calculated to observed effects are mainly due to effects of temperature.

## APPENDIX B.

## CALCULATION OF THE EFFECT OF AN ANEURISM.

The above formulæ contain all that is necessary for work of this kind. But there is one special application about which a little farther explanation is necessary.

In calculating, for the general table in Appendix E below, the effect of the aneurism nearest to the principal bulb, which is the only one of importance, I have taken the following plan.

I assumed the section of the aneurism through the axis to be bounded by a simple harmonic wave curve complete from trough to trough, which agrees very exactly with its apparent outline as seen through the wall of the tube. Hence, if  $2a$  be the greatest diameter of the aneurism,  $2b$  the diameter of the tube, and  $l$  the length of the aneurism, its volume is

$$\frac{\pi l}{8} (3a^2 + 2ab + 3b^2).$$

Or, if we write  $n$  for the ratio  $a : b$ , the aneurism adds to the volume of mercury in the part of the tube containing it an amount equal to that contained in a length

$$\frac{3n^2 + 2n - 5}{8} l,$$

of the unaltered tube.

It has been stated in the text that the diameters of the aneurism and of the bore appear magnified in the same proportion. Hence it was only necessary to measure them carefully, in terms of any common unit, by means of a small telescope with a micrometer eyepiece, in order to find the value of  $n$  in the above expression.

I have not thought it worth while to attempt the complex problem of calculating the effect of pressure on the aneurism, having simply assumed that the volumes of all parts of the bore are diminished in the same proportion, viz. by  $\frac{1}{10000}$ th for each ton-weight of pressure. This makes all my numbers in the 11th column of the table too small. But the error is of no consequence except for one or two of the instruments, in which the aneurism appears almost to fill the whole external diameter of the tube; and, even then, it will in no case affect the first figure of the tabular result. A somewhat greater error (also in defect) affects the numbers in the 10th column, for I have not taken account of the aneurisms at the bends of the tube. These are, however, in all cases much smaller than that first referred to, and the numbers for the maximum index are of no great practical importance.

## APPENDIX C.

## HEATING OF WATER BY COMPRESSION.

In the paper referred to in the text, Sir William Thomson gives for the rise of temperature of a fluid, the pressure on which is suddenly raised from  $p$  to  $p + \varpi$ , the general expression  $\frac{te}{JK} \varpi$ . Here  $t$  is the absolute temperature of the fluid;  $e$  its coefficient of expansion, and  $K$  its average capacity for heat, under constant pressure, between  $p$  and  $p + \varpi$ .  $J$  is Joule's equivalent.

The value of  $e$ , as given by Kopp's experiments, is nearly

$$\frac{t - 278}{72,000}$$

for temperatures within 20° C. of the maximum density point. The mean of the experimental determinations of Matthiessen, Pierre, and Hagen, makes it about 5 or 6 per cent. greater.

For the Centigrade scale the value of  $J$  is 1390 foot-lbs. An atmosphere of pressure is nearly 2117 lbs. weight per square foot; and  $K$  is about 63.45 (the number of pounds of water in a cubic foot).

Hence it follows that, for one additional atmosphere of pressure, the temperature of water is raised (in degrees Centigrade) by about

$$\frac{t(t - 278)}{2,850,000}$$

Now 56° F. is 13°.3 C., for which  $t = 287.3$ , and the rise of temperature produced by a ton-weight per square inch is 0°.14 C. or 0°.25 F.

This is the statement in the text.

From the above formula we find the heating effect of one ton pressure on water at 50° F. to be nearly 0°.16 F.; and for each degree above or below 50° F. this number must be increased or diminished by about one-tenth of its amount.

This expression is very easy to recollect, and it gives the results with ample accuracy throughout the whole range of temperatures (40°—60° F.) within which my experiments were conducted.

It is to be observed that Thomson's formula is strictly true for small pressures only. No account has been taken of a possible lowering of the temperature of maximum density, or of a change of expansibility, under pressure. Nor is it known how a considerable increase of pressure affects the thermal capacity.

## APPENDIX D.

### THE APPARATUS EMPLOYED.

The plate appended shows in section and in elevation the Fraser gun in which the thermometers and gauges were exposed to pressure. The following memorandum from the Royal Gun Factories sufficiently explains the material, mode of construction, and dimensions of the instrument. The plate is copied from the sketch which accompanied the memorandum.

*“Memorandum on the Construction of Testing Cylinder for Sir Wyville Thomson.*

“No. 1. Interior tube is made of mild steel, similar to that used for inner tubes of guns, and containing a very small amount of carbon. The tube has been tempered in oil, and its limits of elasticity when in tension are about 30 tons per square inch. The ultimate tenacity of the metal is about 45 tons per square inch.

“No. 2. The key and plug are made of similar material, and have also been tempered in oil, and their limits of strength correspond to those of the inner tube.

"No. 3. The intermediate coils *B* and *B*<sup>1</sup> were made by coiling a bar of this section round a cast-iron mandril, and then welding this coil into a compact hollow cylinder, open at both ends, and the fibre of the iron running round and round the circumference of the cylinder.

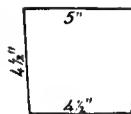

"The exterior coil *C* was made in a similar manner, on a larger mandril from a bar of this section, and coiled in the reverse direction to the inner coil.

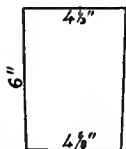

"The cylinders were then bored and turned.

"The steel cylinder *A* was turned .01 of an inch *larger* than the interior of the intermediate coils *B* and *B*<sup>1</sup>; the coils were then heated to expand them, and were put on to the steel cylinder and allowed to cool. When cold, the exterior of *B* and *B*<sup>1</sup> was turned .02 of an inch larger than the interior of the cylinder *C*, which was then heated and put on the cylinder *B*-*B*<sup>1</sup>.

"The strength of the iron of which the coils are made is about 20 tons circumferentially, and 10 tons in a longitudinal direction with the cylinder.

"No. 4. The inner steel cylinder *A* was subjected to hydraulic pressure *before* the outer coils were shrunk upon it, of about 2½ tons per square inch, in order to test the general soundness of the metal.

"No. 5. The cylinder in its present condition may be worked with safety up to 18 or 20 tons per square inch. Of course the breaking strength, calculated in the resistance of the several parts of the cylinder, is very much greater.

"No. 6. The weights of the several parts are as follows:—

	Tons	cwts.	qrs.	lbs.
"Cylinder . . . . .	3	1	0	0
Key . . . . .	0	0	3	14
Plug . . . . .	0	0	1	27
Total . . . . .	3	2	1	13

"17/2/79.

(Signed) C. W. YOUNGHUSBAND, *M. Genl.*"

The instrument was erected in a basement room on the north side of the College, on a stone slab 18 inches thick, which was supported by a large mass of concrete imbedded in the ground below the floor, and in no way connected with the building.

A wooden platform, 3 feet 9 in. high, was erected round the instrument to facilitate access to the chamber from the top. When very high pressures were to be applied, a wooden screen, lined with sheet-iron, was erected under the platform as a defence against nuts or other pieces of metal, in case part of the lower fittings (by far the weakest part of the whole) should give way. This precaution was taken in consequence of an accident which had happened with the old pressure apparatus. Although no great pressure had been reached, a screw was stripped, and the nut projected with considerable violence.

The nature of these lower fittings will be seen at once from the woodcut annexed. A block of iron, with lateral attachments for the pump and for the external gauge, was fixed by three powerful vices to the external flange of the steel core of the pressure-chamber. It was pierced by a hole of 1/16th inch diameter, exactly in line with the hole in the steel cylinder above. This hole was closed below by a screw-tap, so that by withdrawing the tap a steel wire could be easily passed into the pressure-chamber in case of obstructions

in the narrow tube. This hole was intersected at right angles by another bore, communicating at its ends with the lateral attachments. To prevent leakage where the block was

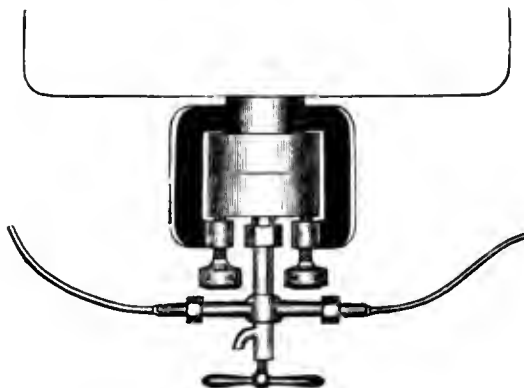

pressed against the lower flange of the steel cylinder, we first employed a leather washer. But for this we afterwards substituted a washer of block tin. This was found to work admirably. Copper washers are employed at smaller junctions. The tubes connecting the apparatus with the pump and with the external gauge are of copper, half-an-inch in diameter, and  $\frac{1}{16}$ th inch in internal bore. The pump has a bore of 0.25 inch; and the piston, which is a solid steel rod with a sharp cup-shaped end (like the large plug) has a stroke of 2.16 inches. At the usual rate of working of the gas-engine, there are 44 strokes per minute. All these fittings were executed in Edinburgh after the arrival of the main tube from Woolwich.

The plug was supported by block and tackle from a strong beam fixed in the walls of the apartment, 5 feet above the upper end of the pressure apparatus.

The key was originally planed true to the slot, but it was deemed prudent to reduce (very slightly) its depth; lest, under great pressures, it might flex at the plug and become permanently jammed.

During the winter session, when the temperature conditions were most favourable, I was in general unable to find time for more than one experiment each day. But the great capacity of the pressure-chamber enabled me to operate on five thermometers at once, three gauges and sometimes other apparatus being also introduced. At least one thermometer was common to every two batches of five thus operated on.

The mode of conducting an experiment was as follows:—

The thermometers, gauges, &c., to be operated on had been left all night, in light tinned-iron cans, in the pressure-chamber, which was full of water. The cans were lifted out, full of water, and the thermometers and gauges were then taken out one by one and read, after the indices had been adjusted by the external magnet. The instruments having been restored to the cans, these were at once lowered into the pressure-chamber, which occasionally required to have a small additional quantity of water put in. This was taken from a vessel which had been kept standing beside the pressure vessel all night. The plug, carefully coated with a mixture of tallow and oil, was then let down into the cylinder, and pressed down by hand as far as possible. Then one of the working party mounted (by means of the tackle) on the top of the plug, which was thus gradually forced in by

his weight, till it just passed the slot. At that instant another of the party opened the screw-tap below, to allow the escape of water. A third mounted on the platform, and with a marlin-spike occasionally gave a slight rotation to the plug in its descent; so that when it was home there should be a clear passage for the large steel key through the slots in the walls of the tube and in the plug. The moment that the key was shot in, the screw-tap below was closed, the external gauge read, and the gas-engine turned on. After a little practice the observer at the external gauge could give a signal to throw off the engine, so that the pumping should be stopped exactly when the desired pressure was reached.

The thermometers, &c. were then left under full pressure for about three minutes only; during which interval the pressure, when originally three tons, lost at the utmost about 1.5 per cent.—usually, however, not more than about 0.8 per cent. A pressure of three tons, when there were no air-gauges in the pressure-chamber, was generally reached in six or seven minutes. After the three minutes' interval the screw-tap was very slowly opened, so that the relaxation of pressure usually occupied from one and a half to two minutes. [When the tap was less slowly opened, the issuing stream of water was at a temperature many degrees higher than that of the iron vessel—an excellent instance of what was said in the text above about the heat developed by friction in narrow channels.]

I have satisfied myself, by trials both with this large apparatus and with the smaller one soon to be described, that, for the object I had in view, nothing was to be gained by prolonging the exposure of the instruments to pressure. A very slight additional compression might probably have resulted; but it would in all cases have produced much less effect on the thermometers than that due to changes of temperature in the room towards afternoon, especially with several persons working for a considerable time round the apparatus. This was the case when we were working at an initial temperature of 40° F., when water is not heated by pressure. When we worked at temperatures of 50° F. or upwards, it would have been vain to expect anything from protracted pressure; for the sudden rise of temperature in the water is soon greatly diminished by the good conducting power of the steel gun, and the large capacity of three tons of steel and iron, as compared with that of 25 lbs. of water. Thus the mercury in the thermometers falls away from the index,—so that, even if a farther compression took place under continued pressure, the index would not be affected by it. This cooling explains, to a great extent, the apparent leakage described in the last paragraph.

After the pressure had been let off, our most formidable difficulty presented itself, viz., the extraction of the plug with as little as possible of a jerk, and (especially when there were air-gauges in the instrument) with as little exhaustion of pressure as possible. To do this with perfect steadiness, and with the requisite slowness imposed by the great length and very small bore of the lower aperture, a powerful screw-jack would have been required. But, though I have an instrument of the kind, I determined to do as well as I could without it, as the necessary fittings would have been not only expensive, but exceedingly cumbersome, and would have greatly extended the time required for each experiment. The method adopted was to haul the tackle tight, but not so tight as to start the plug; and then, by pinching two laps of the chain together, to produce the desired result. There was always about  $\frac{1}{3}$ th or  $\frac{1}{6}$ th of the air sucked out in this way from our air-gauges, except when we took the precaution of putting into the chamber before commencing operations a large inverted vessel full of air. This works well enough in some respects, but it is objectionable for several reasons, especially the heat developed in compressing air.

mode was to force out the plug by reapplying pressure after the key had been extracted. This was, of course, a very tedious operation as, even when no air-gauges were in the apparatus, at least 900 strokes of the pump were required:—for the section of the plug is 16 square inches, and it had to be raised 5·6 inches, the pump inserting  $\frac{1}{10}$ th of a cubic inch of water at each stroke. Any other mode of meeting this difficulty would have involved a weakening of the apparatus, which could not be permitted.

The smaller pressure apparatus, already alluded to, is figured in section in the woodcut. Its bore is one inch in diameter; and its content, when the plug is in, is about nine cubic inches. A single stroke or two of the pump only is required to produce in it a pressure of three to four tons. The important feature in its construction is the large flange by which the lower end, with its fittings, is attached. Between the flanges two large leather washers (carefully soaked in wax) are compressed by means of six powerful screws. Their object is to enable us to insert a thermo-electric junction in the pressure-chamber, the other junction of the circuit being outside. In the sketch the covered wires (copper and iron of 23 gauge, two of each metal) are seen twisted together and extending up the chamber in a corkscrew form with the junction at the top. This arrangement enables the experimenter to raise the junction above the top of the cylinder when he wishes to fit it into a mass of any substance which is to be tested for the heat developed by compression. The wires pass out, each by itself, and are laid in a serpentine form between the leather washers. A day or two after it was first set up, this apparatus leaked considerably at the flange, but by tightening the screws a second time it was made, and still remains, almost perfectly water-tight even up to five and six tons pressure.

By means of this apparatus I have measured directly the rise of temperature, produced by pressure, in a great variety of substances. Some of my results will be found in the *Proc. R.S.E.*, May 1881. I do not insert them here, but content myself with mentioning that they fully bear out the results already obtained with vulcanite and lard by means of the larger apparatus.

One or two other remarks as to the behaviour of the thermometers under pressure may conveniently be inserted here, as they serve to explain some of the results obtained during the expedition.

On the first occasion on which one of the thermometers gave way, we were much surprised at the loudness and musical quality of the sound produced. The whole mass of iron and steel vibrated like a bell in consequence of the (comparatively slight) sudden relaxation of pressure. On another occasion, just as a pressure of three and a half tons had been reached, the whole apparatus gave a strong, protracted musical sound, which continued until the screw-tap was opened. This was probably due to a species of hydraulic-ram behaviour on the part of one of the valves of the pump. These are little conical pieces of steel, with the points much elongated, which are ground accurately into conical beds, and fall back into their places by gravity. It was not observed that this powerful vibration had in the least degree altered the position of the indices in the thermometers or gauges which were in the pressure-chamber. Their indications agreed perfectly with those of the preceding and succeeding day.

I made a number of experiments with the view of determining the amount of distortion at which glass gives way, with the view of finding the limit of strength of a glass tube, and also the ratio of external to internal diameter to secure it against any assigned lower pressure.



The approximate results of these experiments are given in Appendix A, but I allude to them now in consequence of a curious fact observed, which gives the explanation of a singular

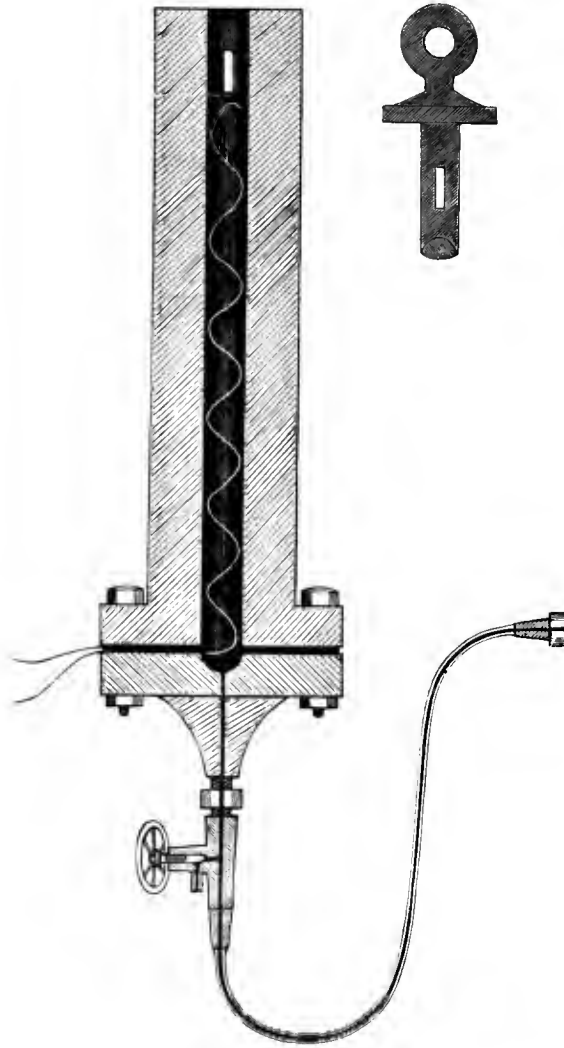

occurrence noticed on board the Challenger. The walls of the tubes, when they gave way, were crushed into fine powder, which gave a milky appearance to the water in the compression apparatus. But the fragments of the ends were larger, and gave much annoyance by preventing the valves of the apparatus from closing. To remedy this inconvenience, I enclosed the glass tube in a tube of stout brass, closed at the bottom only, but was surprised to find that it was crushed almost flat on the first trial. This was evidently due to the fact that water is compressible, and therefore the relaxation of pressure (produced by the breaking of the glass tube) takes time to travel from the inside to the outside of the brass tube; so that for about  $\frac{1}{10000}$ th of a second that tube was exposed to a pressure of four or five tons weight per square inch on its outer surface, and no pressure on the inner. The

impulsive pressure on the bottom of the tube projected it upwards, so that it stuck in the tallow which fills the hollow of the steel-plug. Even a piece of gun-barrel, which I substituted for the brass tube, was cracked, and an iron disc, tightly screwed into the bottom of it to close it, was blown in. I have since used a portion of a thicker gun-barrel, and have had the end welded in. But I feel sure that an impulsive pressure of ten or twelve tons weight would seriously damage even this. These remarks seem to be of some interest on several grounds, for they not only explain the crushing of the open copper cases of those of the Challenger thermometers which gave way at the bottom of the sea, but they also give a hint explanatory of the very remarkable effects of dynamite and other explosives when fired in the open air. [It is easy to see that, *ceteris paribus*, the effects of this impulsive pressure will be greater in a large apparatus than in a small one.]

## APPENDIX E.

### TABULAR SYNOPSIS OF THE GENERAL RESULTS OF EXPERIMENT AND CALCULATION.

The first four columns of the table give the numbers by which the various thermometers were distinguished; 1 in my Laboratory, 2 on board the Challenger, 3 by Captain Davis, 4 by the maker Mr Casella.

The series of thermometers A 1, . . . A 26, though they were used on board the Challenger, are the private property of Sir Wyville Thomson, and were not uniformly stamped, as were the Challenger thermometers proper, with their numbers on the copper cases. Hence, when they were obtained from Captain Tizard, it appeared necessary to put on some distinguishing mark, and the titles X, LV, †, &c., were the chance devices on little tablets which were at once affixed to each of the instruments which had no outward distinguishing mark. I have since found the means of recognising, without uncertainty, each of the instruments.

The fifth column gives the correction supplied to the Admiralty by Captain Davis for those thermometers which he tested. The correction is, in all cases, for 2500 fathoms. With reference to the numbers in this column, the following extract from a letter addressed to me by Captain Tizard (of date 11th January, 1881) must be kept well in view:—

“The method employed by Captain Davis, in experimenting on the thermometers, was to place in the press, with the instruments on trial, one of Phillips’ thermometers, enclosed in a tube on Sir William Thomson’s principle. He took it for granted that this perfectly enclosed thermometer would not be affected by pressure; but that any alteration of its index would be due to the generation of heat in forcing the water into the press. The alteration of its index, which was always of very small amount, was deducted from the alterations in the indices of the instruments on trial, and the differences assumed to be the errors of the thermometers at a given pressure. But, as I mentioned to you before, this alteration was always on the maximum side of the tube, and not the minimum. Consequently it appeared to us to require considerable modification.”

On this it is necessary to remark that the indication of the Phillips’ thermometer (as is obvious from the text above) is not due to heating of the water in the press alone, but also to the heating effect of pressure upon the strong protecting tube. Thus I have no direct means of comparing my results quantitatively with those given by Captain Davis.

Under the circumstances, I have done what appeared to me best for obtaining a rough comparison. I have given in column 7 the observed effects of a pressure of three tons (nearly 2500 fms.) on each thermometer. In column 8 the temperatures are given, and in column 9 the corresponding temperature-change (by Thomson's formula.—Appendix C, *ante*). Column 6 gives the differences of the numbers in columns 7 and 9; and these differences may be roughly compared with those of Captain Davis in column 5. There is a general agreement, but my reduced numbers are, on the whole, rather greater than those of Captain Davis.

This may be ascribed, in part, to the fact that in Captain Davis' apparatus (as I understand) the water was pumped in *from above*, and thus the heat developed by friction did not affect his results. And it may be due in part to inadequate measurement of pressure,—a point which was impressed on me from the very commencement of my work. I have learned from Mr Casella that the pressure gauge employed by Captain Davis has been broken; so that it is impossible now to verify his scale of pressures. To show how possible is a serious mistake in this matter, I append a comparison of the indications of the very elaborate gauge attached to the old Challenger apparatus with those of my steel external gauge already described. The scale of the Challenger gauge is divided to cwts. on the square inch. My gauge gives very nearly 20 mm. per ton; so that, for a rough comparison, we may take 1 mm. as equivalent to 1 cwt. The two instruments were simultaneously attached to the pump, and the pressure was therefore the same in both at each reading. There can be no doubt whatever, from repeated comparisons with glass gauges of all sizes and shapes, that my gauge follows Hooke's law with great accuracy. The only possibility of serious error is in the actual value of the unit. This important determination has, however, been very carefully repeated by the aid of Amagat's numbers and the indications of the silvered gauge already described; and the result is as above stated.

Steel Gauge. Millimetres.	Challenger Gauge. Cwts. per sq. in.	Ratio.
0	0	...
5	0	0·0
9	1·2	0·13
15	8·7	0·58
20	13·9	0·69
30	23·6	0·78
40	35·0	0·87
50	47·0	0·94
60	58·7	0·98
70	71·7	1·02

The comparison was repeated several times with almost exactly the same results.

It is quite clear that the Challenger gauge does not follow Hooke's law. It lags behind the steel gauge at first (does not give any indication, in fact, till the pressure is nearly 50 atmospheres), then gradually gains on it; and, at pressures greater than  $3\frac{1}{2}$  tons, appears to leave it rapidly behind. The instrument is, however, graduated up to 4 tons only. My very first experiments with this Challenger instrument, in which I used a simple form of manometer, showed that it was not trustworthy, and led me to make various trials for the purpose of getting a proper mode of measuring high pressures.

[Inserted, July 8, 1881.—After recently examining a number of gauges of the Bourdon pattern, some constructed to read to 600 atmospheres, I again tried the old Challenger gauge. The result was very remarkable. Four successive trials agreed very closely with each other in giving

Steel Gauge. Millimetres.	Challenger Gauge. Cwts. per sq. in.	Ratio.
0	0	...
10	10·6	1·06
20	20·3	1·02
30	31·0	1·03
40	42·8	1·07
50	54·1	1·08
60	65·7	1·09
70	78·7	1·12

A comparison of these, with the numbers of the former trials, shows that all the readings are increased by somewhere about 7 cwts. This seems to show a definite slip of one of the bearings, or possibly a new arrangement of the teeth gearing with one another in the two toothed arcs. But whatever be the cause, the untrustworthiness of the gauge is obvious.]

Columns 10 and 11 give the pure pressure effect on each of the thermometers, as calculated from the measured dimensions of each instrument and of its principal aneurism by the help of the formulæ in Appendices A and B. The numbers given for the maximum side of each instrument are all slightly too small, as I have not allowed for the effects of the (comparatively trifling) aneurisms at the bends of the tube. Those given for the minimum side are the only ones of real importance; and, in calculating these, all accessible details have been carefully attended to. One or two of the instruments were entirely smashed, so that no trace of the main aneurism was left. In such a case the correction has a + inserted after it. In the other broken instruments the aneurism was still measurable, and the correction has been adequately determined.

The remaining columns of the table give the scale errors of the thermometers at 50° F. These were determined casually in the course of the work, by comparing with a Kew Standard the thermometers for trial next day, which were (for this purpose) kept for some hours in a steady stream of water. These numbers are not given as exact, though they are probably very near the truth. I have noticed that the scale error, in a thermometer with two liquids in contact, varies within considerable limits at any one temperature, according as the thermometer has been *raised* to that temperature from a lower one, or *cooled down* to it from a higher. I found an excellent illustration of this in some of my glass pressure-gauges, where (for the purpose of allowing the interior plug to be seen) I at first employed a transparent liquid in the bulb, with a short column of mercury in the stem to move the index. In some of these instruments, after they had been several times exposed to high pressures, a film of the transparent liquid entirely surrounded the column of mercury, which could then move pretty freely, even in the narrow tube, under the action of gravity. Of course this mode of construction was at once given up.

There seems to be no necessity for the printing of the records of the very numerous experiments which have been made on the various thermometers. In the text above, I have said enough to show that the true pressure correction to be applied to the deep sea observations is exceedingly small, and in column 11 of the annexed table it is calculated with all

Laboratory Number	Challenger Number	Capt. Davis' Number	Maker's Number	Capt. Davis' Correction for 2500 fathoms. (Negative)	Effect of a Pressure of 3 tons, at temperature in next column	Temperature	Heating of water by 3 tons pressure, at temperature in last column	True Pressure Corrections for 3 tons, at 50° F., calculated from the dimensions of each instrument, and of its principal aneurism. (Negative)		Rough determination of scale-error, at 50° F., the indices being drawn away from the mercury		Remarks		
								Maximum	Minimum	Maximum	Minimum			
								71	71	71	17,429		1.3	1.36
72	72	72	18,126	1.4	...	...	...	...	0.72	0.26	...	...		
77	77	77	18,142	1.5	1.5	2.3	56	0.8	0.80	0.35	(+0.5)	-0.1		
81	81	81	17,911	1.3	1.46	2.2	55	0.74	0.70	0.36	-0.5	+0.3		
83	83	83	18,059	1.5	1.48	2.2	54.5	0.72	0.70	0.26	+0.5	+0.75		
94	94	94	17,715	1.1	1.3	2.1	56	0.8	0.57	0.22	-0.2	+0.1		
A 1	A 1		17,705	...	1.5	2.1	52.5	0.6	0.62	0.25	0.0	-0.45		
VII.	A 2		17,714	...	...	...	...	...	0.68+	0.18+	...	...	Completely smashed, 6/7/80.	
A 3	A 3		17,718	...	1.56	2.4	57	0.84	0.88	0.25	-0.1	-0.5		
IV.	A 5		17,707	...	1.6	2.2	52.5	0.6	0.62	0.21	-0.15	-0.25		
X.	A 7		17,712	...	1.5	2.2	54	0.7	0.76	0.39	-0.05	+0.05		
A 8	A 8		17,721	...	1.3	1.9	52.5	0.6	0.50	0.18	+0.05	-0.15		
XX.	A 9		17,709	...	1.58	2.4	56.2	0.82	0.86	0.41	+0.1	+0.1		
VIII.	A 10		17,706	...	1.28	1.9	53	0.62	0.77	0.31	0.0	-0.25		
A 11	A 11		17,702	...	1.3	2.1	56	0.8	0.70	0.24	-0.2	-0.2		
+	A 12		17,903	...	1.6	2.3	54	0.7	0.80	0.31	-0.15	+0.15		
* Nil	A 13		17,908	...	...	...	...	...	0.77	0.33	...	...	(Exploded after mending, 17/7/80. Captain Tizard records it broken, 23/3/75. Completely smashed, 9/7/80.	
VI.	A 15		17,899	...	...	...	...	...	0.61+	0.2+	-0.4	+0.4		
A 16	A 16		17,904	...	1.78	2.4	53	0.62	0.76	0.31	+0.15	0.0		
LI.	A 17		17,704	...	...	...	...	...	0.62	0.22	+0.05	0.0	(Maximum index sticks, and mercury passes it.	
A 18	A 18		17,479	...	1.5	2.1	52.5	0.6	0.61	0.29	-0.15	+0.25		
A 19	A 19		17,914	...	1.38	2.2	56.5	0.82	0.72	0.29	+0.15	-0.05		
XI.	A 20		17,901	...	1.33	2.05	54.5	0.72	0.66	0.26	+0.45	+0.65		
LV.	A 22		17,909	...	1.3	2.1	56	0.8	0.69	0.32	-0.1	-0.7		
* III.	A 24		17,441	...	1.7	2.5	56	0.8	0.76	0.36	0.0	+0.7		
A 25	A 25		17,906	...	1.4	2.2	56	0.8	0.76	0.32	-0.2	+0.1		
0.1	0.1	23,324		1.2	1.18	1.8	53	0.62	0.57	0.29	+0.05	+0.05		
0.2	0.2	23,325		1.0	0.86	1.6	55	0.74	0.56	0.18	+0.1	-0.3		
0.5	0.5	23,329		1.0	1.3	1.9	52.5	0.6	0.52	0.21	+0.25	-0.15		
0.6	0.6	23,330		1.0	1.28	1.9	53	0.62	0.63	0.28	+0.05	+0.25		
* XXIII.	...	...	37,741	...	0.94	1.7	55.5	0.76	0.44	0.13	+0.3	+0.2	(This is in all respects like the others, except that there are no aneurisms.	

\* Nil and III. were handed to me by Mr Murray ; XXIII. came direct from Mr Casella. The remainder were sent to me by Captain Tizard.

necessary accuracy. I have already said that no fair comparison can be drawn between the numbers in columns 5 and 6. There is a general resemblance between them, and that is all that could be expected where the modes of obtaining them were so different.

As regards the numbers in column 7 of the table, the remainder, when the corresponding number for the maximum index in column 10 is subtracted, ought to be nearly the same for all the thermometers if the vulcanite supports and cover were similarly applied to each. The differences among them are mainly due to this cause, and it is somewhat surprising to find that they are so nearly alike.

I have so often mentioned Amagat's determinations of the volume of air at different pressures, as the basis of the whole of my measurements, that it is well to give, as I have done in fig. 3 of the plate, a graphic representation of them. The horizontal axis gives pressure of air in atmospheres,—the vertical gives the corresponding densities, or (what comes to the same thing) the pressures calculated from the densities by assuming the truth of Boyle's law. It will be seen that the straight line, which would represent densities in terms of the actual pressures, if Boyle's law were true, lies *below* the curve at first:—*i.e.* air is more compressible at first than Boyle's law would make it. At about a ton (or rather 140 atmospheres), its volume is exactly that which Boyle's law would give; and at higher pressures its compressibility falls farther and farther short of that assigned by the law. But the error caused by assuming Boyle's law to hold good up to one ton pressure is, at its greatest, only about 1 per cent.; and this occurs considerably under 100 atmospheres. Practically, my gauge unit was determined at pressures at which Boyle's law is almost exactly true.

Finally, it may be interesting to mention that a fairly approximate determination of the compressibility of water was made by counting the number of strokes of the pump required to produce a measured pressure in the interior of the large apparatus.

END OF VOLUME I.









